



US00D622906S

(12) **United States Design Patent**
Nanda

(10) **Patent No.:** **US D622,906 S**

(45) **Date of Patent:** **** Aug. 31, 2010**

(54) **RAZOR**

D605,815 S * 12/2009 Furuta D28/48

(75) Inventor: **Puneet Nanda**, Cerritos, CA (US)

* cited by examiner

(73) Assignee: **Dr. Fresh, Inc.**, Buena Park, CA (US)

Primary Examiner—Jennifer Rivard

(74) *Attorney, Agent, or Firm*—Snell & Wilmer L.L.P.

(**) Term: **14 Years**

(57) **CLAIM**

(21) Appl. No.: **29/359,745**

I claim the ornamental design for a razor, as shown and described.

(22) Filed: **Apr. 14, 2010**

DESCRIPTION

(51) **LOC (9) Cl.** **28-03**

(52) **U.S. Cl.** **D28/48**

(58) **Field of Classification Search** D28/44-48;
30/32, 34.05, 34.1-34.2, 41, 44-46, 47-51,
30/57-58, 77-84, 526-539

FIG. 1 is a perspective view of a razor showing my new design;

FIG. 2 is a front view of the razor;

FIG. 3 is a right side view of the razor;

FIG. 4 is a left side view of the razor;

FIG. 5 is a rear view of the razor; and,

FIG. 6 is a bottom end view of the razor.

See application file for complete search history.

The broken lines connecting the outer solid lines of the handle represent the bounds of the claim and form no part of the claimed design.

(56) **References Cited**

U.S. PATENT DOCUMENTS

- 3,571,927 A * 3/1971 Stone D28/46
- D258,016 S * 1/1981 Pace D28/46
- D342,807 S * 12/1993 Smith D28/46

1 Claim, 3 Drawing Sheets

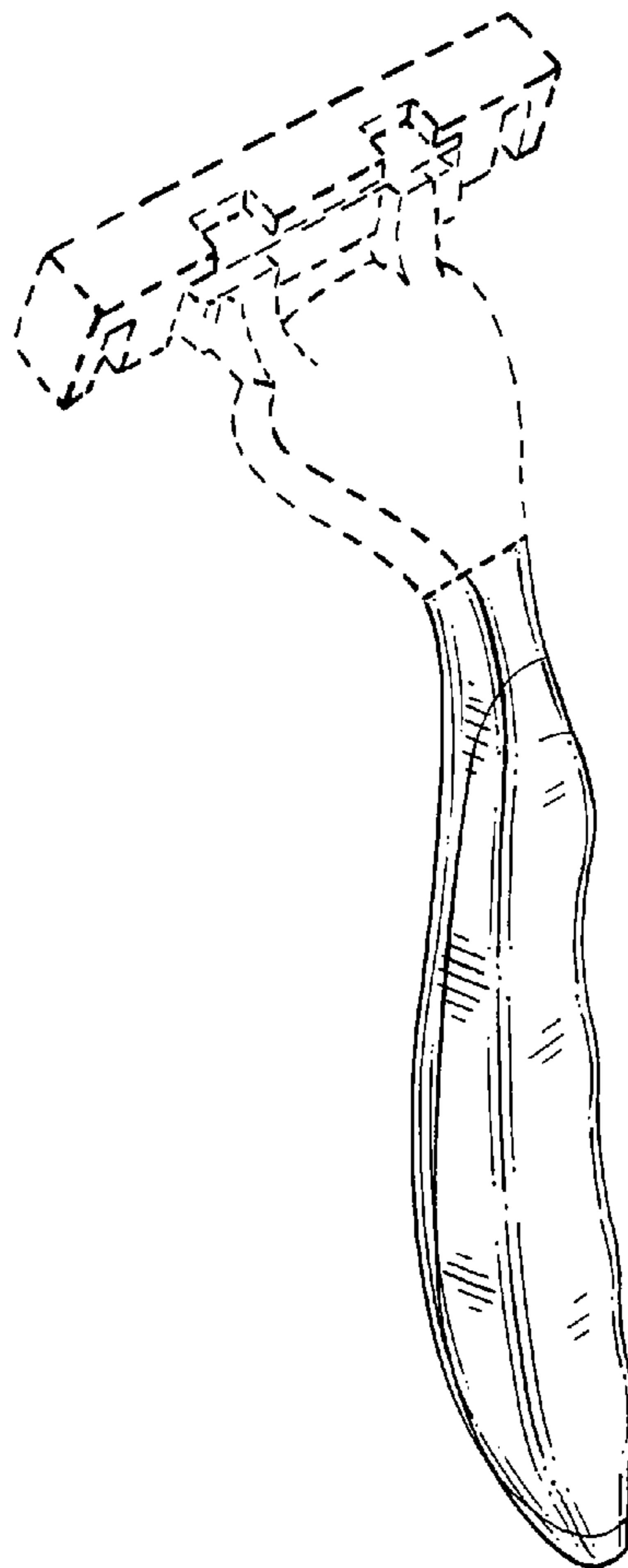

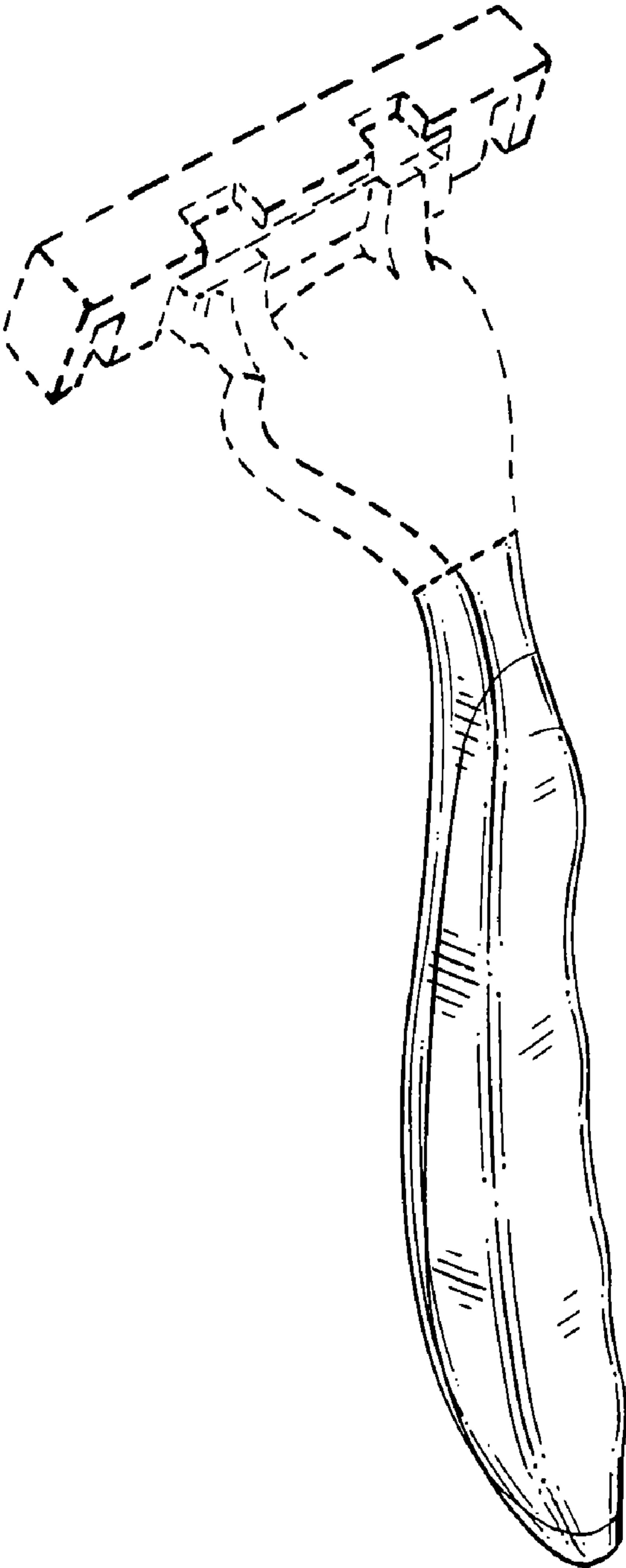

Fig. 1

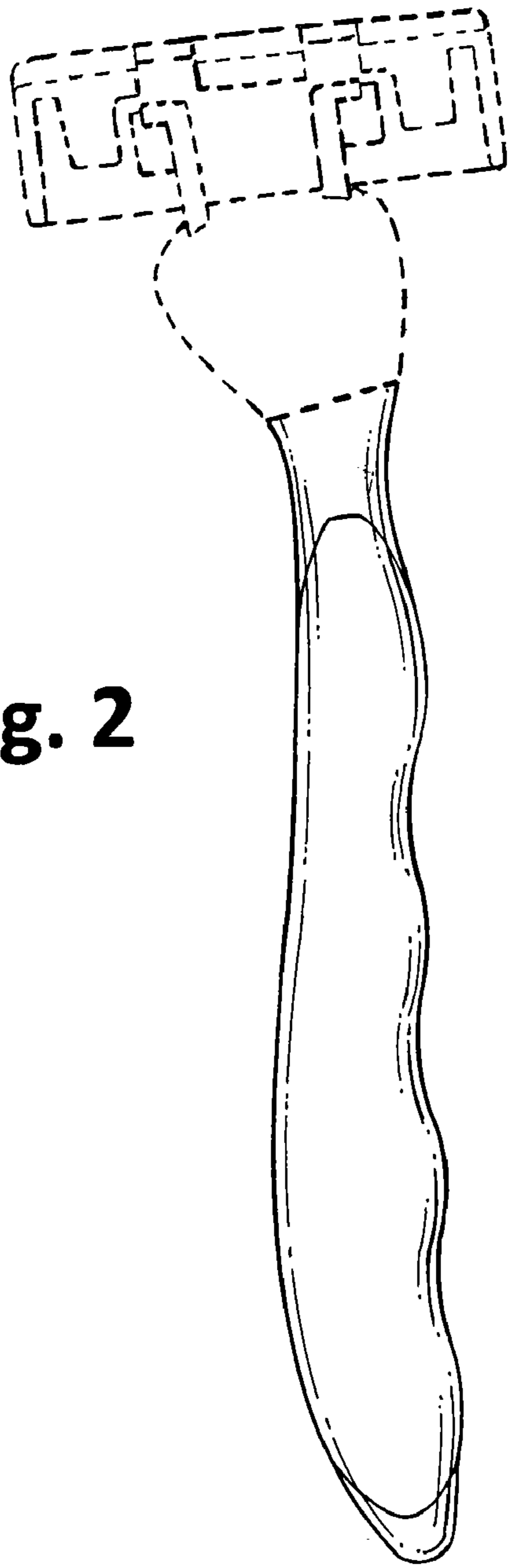

Fig. 2

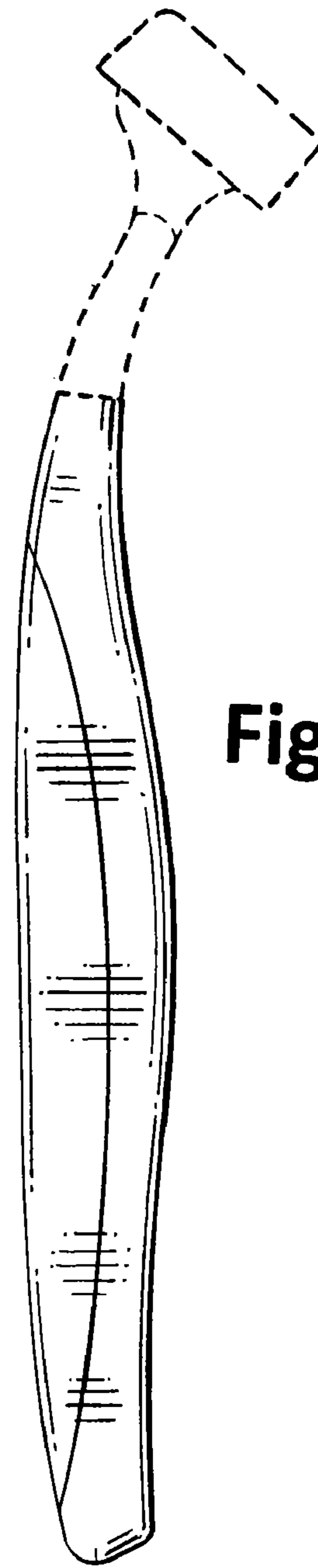

Fig. 3

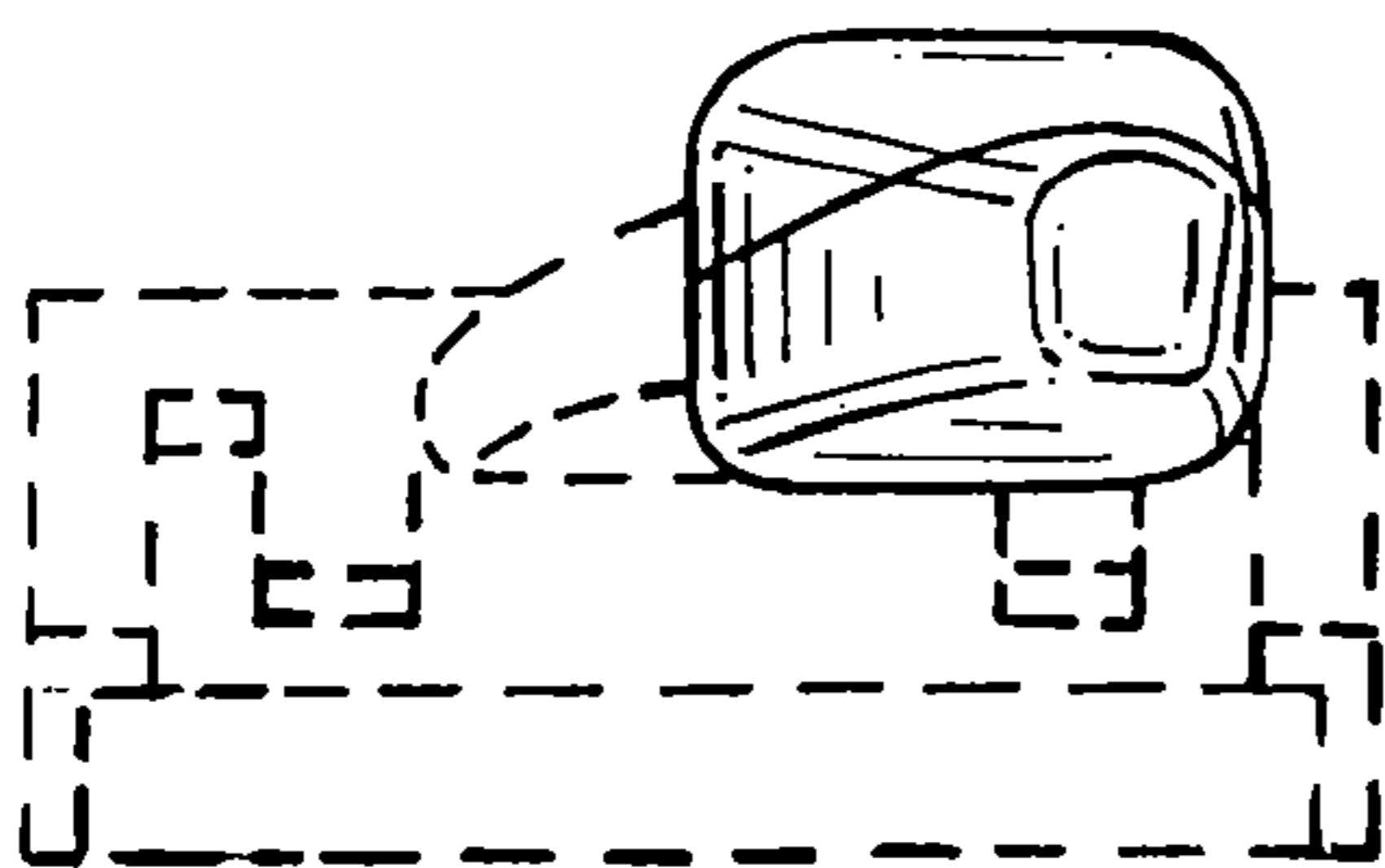

Fig. 6

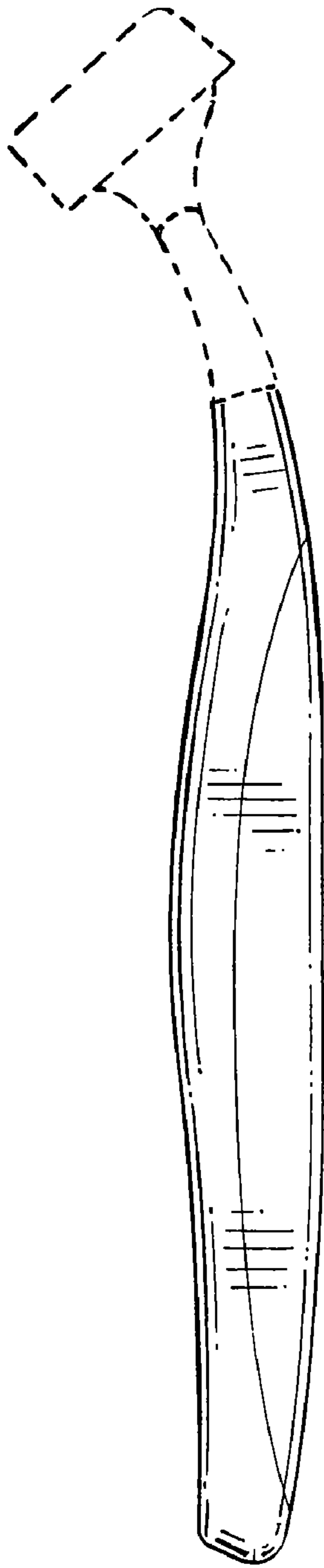

Fig. 4

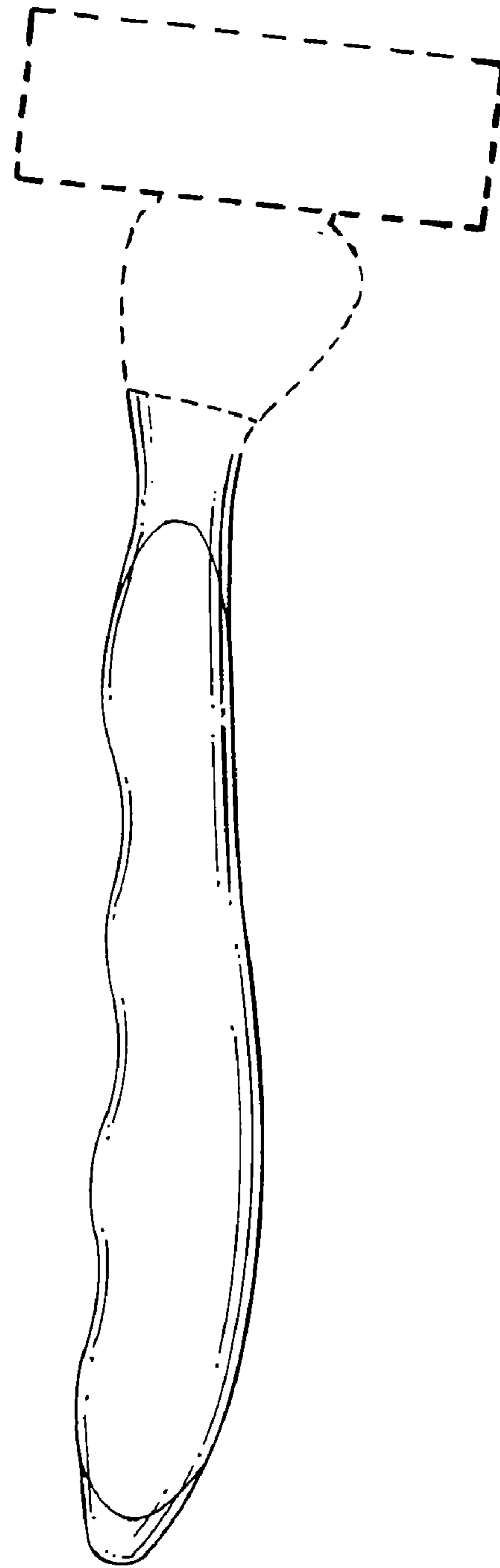

Fig. 5