



US00D622904S

(12) **United States Design Patent**
Kinard et al.

(10) **Patent No.:** **US D622,904 S**

(45) **Date of Patent:** **** Aug. 31, 2010**

(54) **RAZOR CARTRIDGE LUBRICATION RING**

(75) Inventors: **Jennifer Ruth Kinard**, Cambridge, MA (US); **Andrew Anthony Szczepanowski**, North Attleboro, MA (US); **Robert Harold Johnson**, Melrose, MA (US)

(73) Assignee: **The Gillette Company**, Boston, MA (US)

(**) Term: **14 Years**

(21) Appl. No.: **29/351,222**

(22) Filed: **Dec. 2, 2009**

(51) **LOC (9) Cl.** **28-03**

(52) **U.S. Cl.** **D28/47**

(58) **Field of Classification Search** D28/44-48;
30/32, 34.05, 34.1-34.2, 41, 44-46, 47-51,
30/57-58, 77-84, 526-539

See application file for complete search history.

(56) **References Cited**

U.S. PATENT DOCUMENTS

D547,494 S *	7/2007	Watson et al.	D28/47
D550,400 S *	9/2007	Orloff et al.	D28/47
D556,378 S *	11/2007	Watson et al.	D28/47
D563,043 S *	2/2008	Ramm	D28/47
D563,044 S *	2/2008	Ramm	D28/47

D609,404 S *	2/2010	Peyser et al.	D28/47
2007/0107231 A1 *	5/2007	Brown et al.	30/50
2007/0180700 A9 *	8/2007	Sandor et al.	30/41

* cited by examiner

Primary Examiner—Jennifer Rivard
(74) *Attorney, Agent, or Firm*—Joanne N. Pappas; Kevin C. Johnson; Steven W. Miller

(57) **CLAIM**

We claim the ornamental design for a razor cartridge lubrication ring, as shown and described.

DESCRIPTION

FIG. 1 is a perspective view of a razor cartridge lubrication ring;

FIG. 2 is a front view thereof;

FIG. 3 is a back view thereof;

FIG. 4 is a right view thereof;

FIG. 5 is a left view thereof;

FIG. 6 is a top view thereof; and,

FIG. 7 is a bottom view thereof.

The dashed broken lines are directed to the environment and are for illustrative purposes only and form no part of the claimed design.

1 Claim, 5 Drawing Sheets

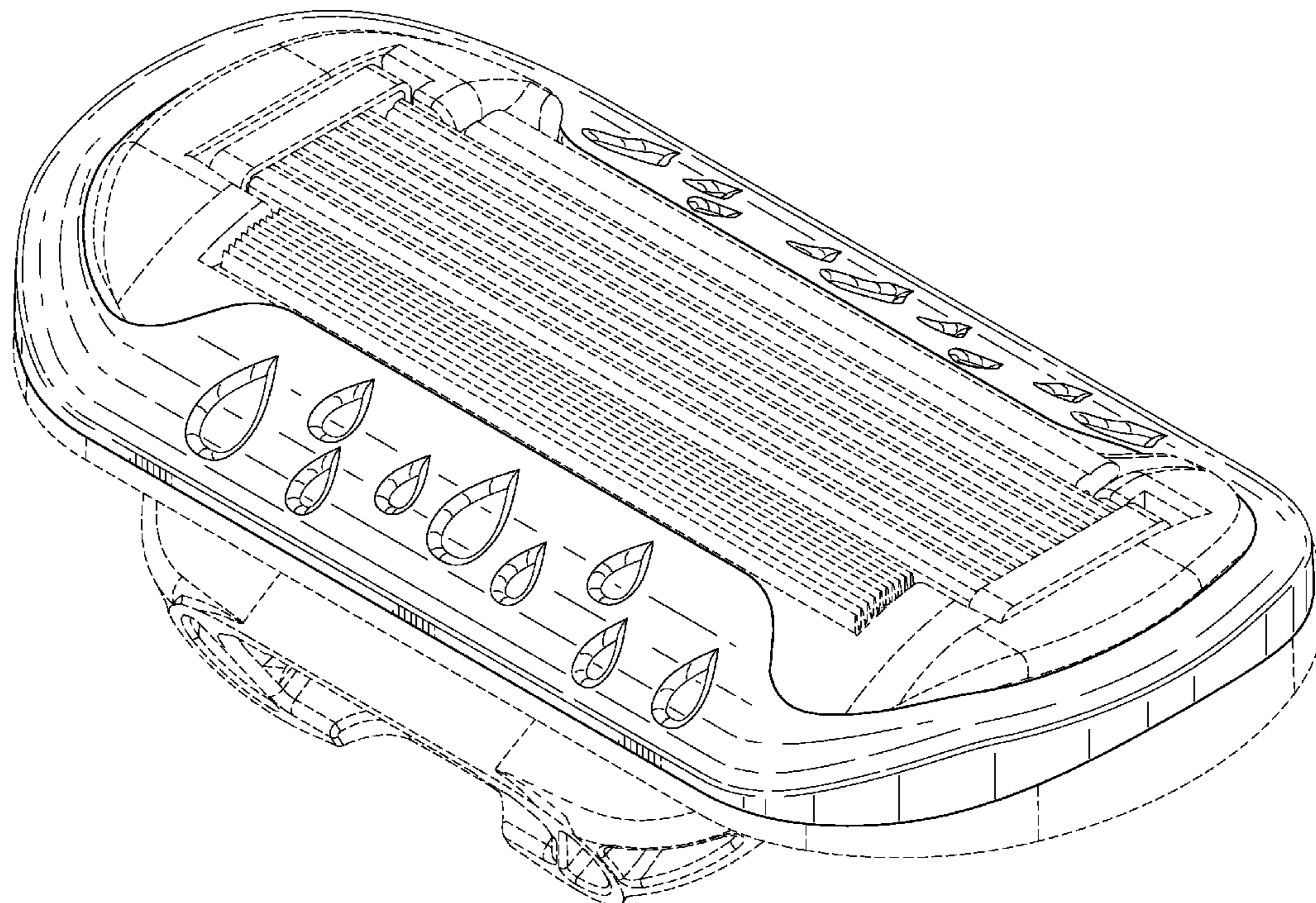

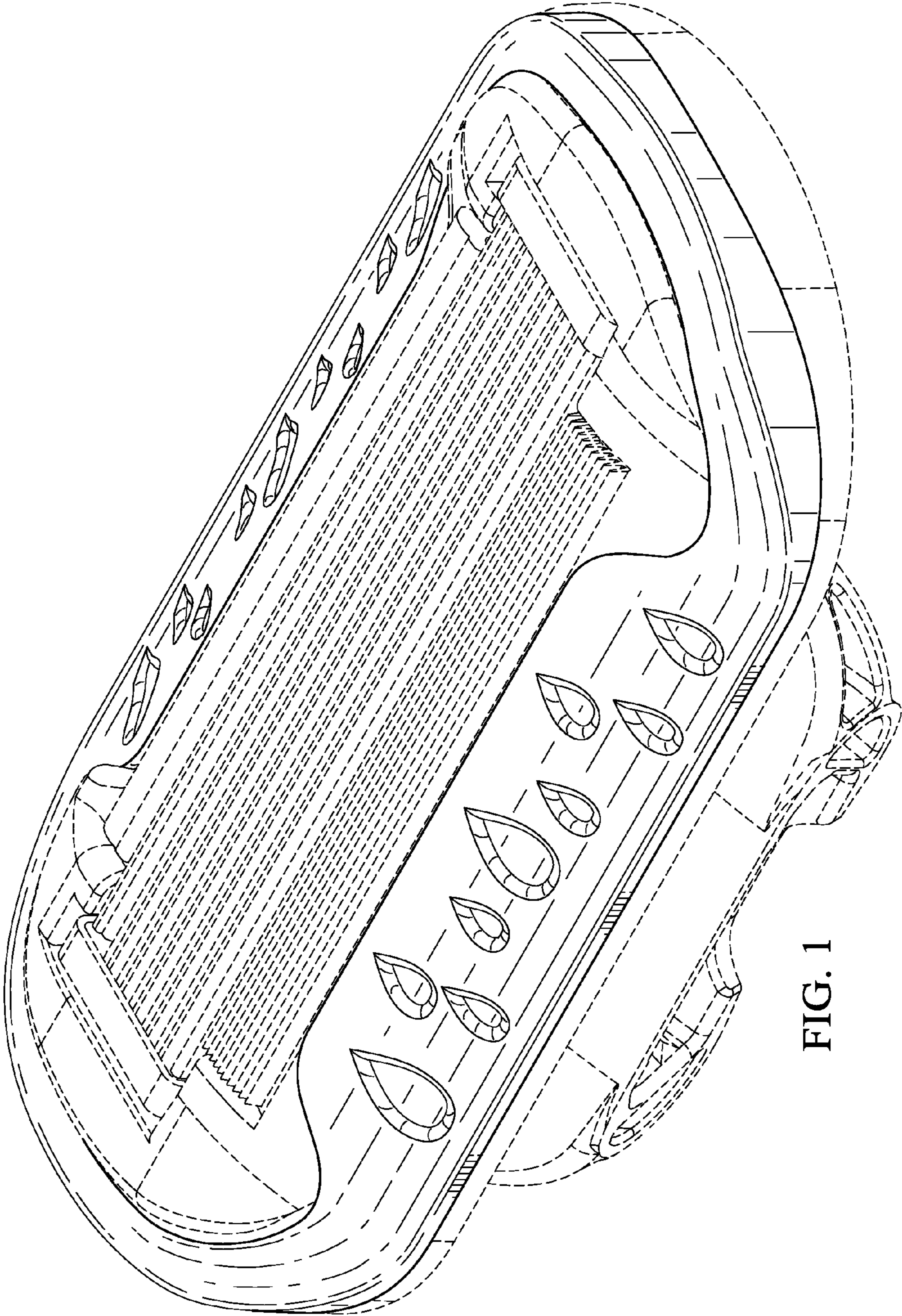

FIG. 1

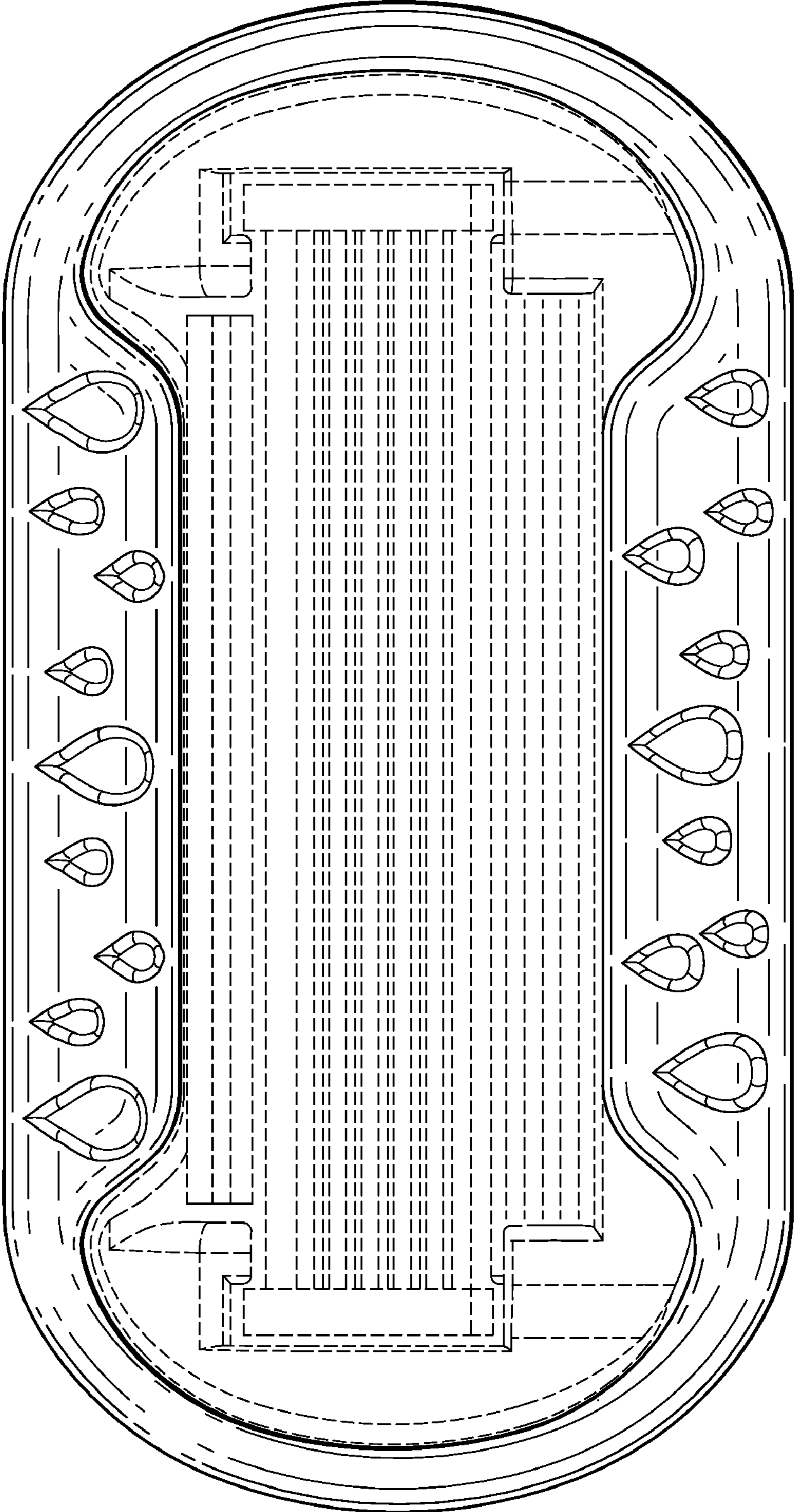

FIG. 2

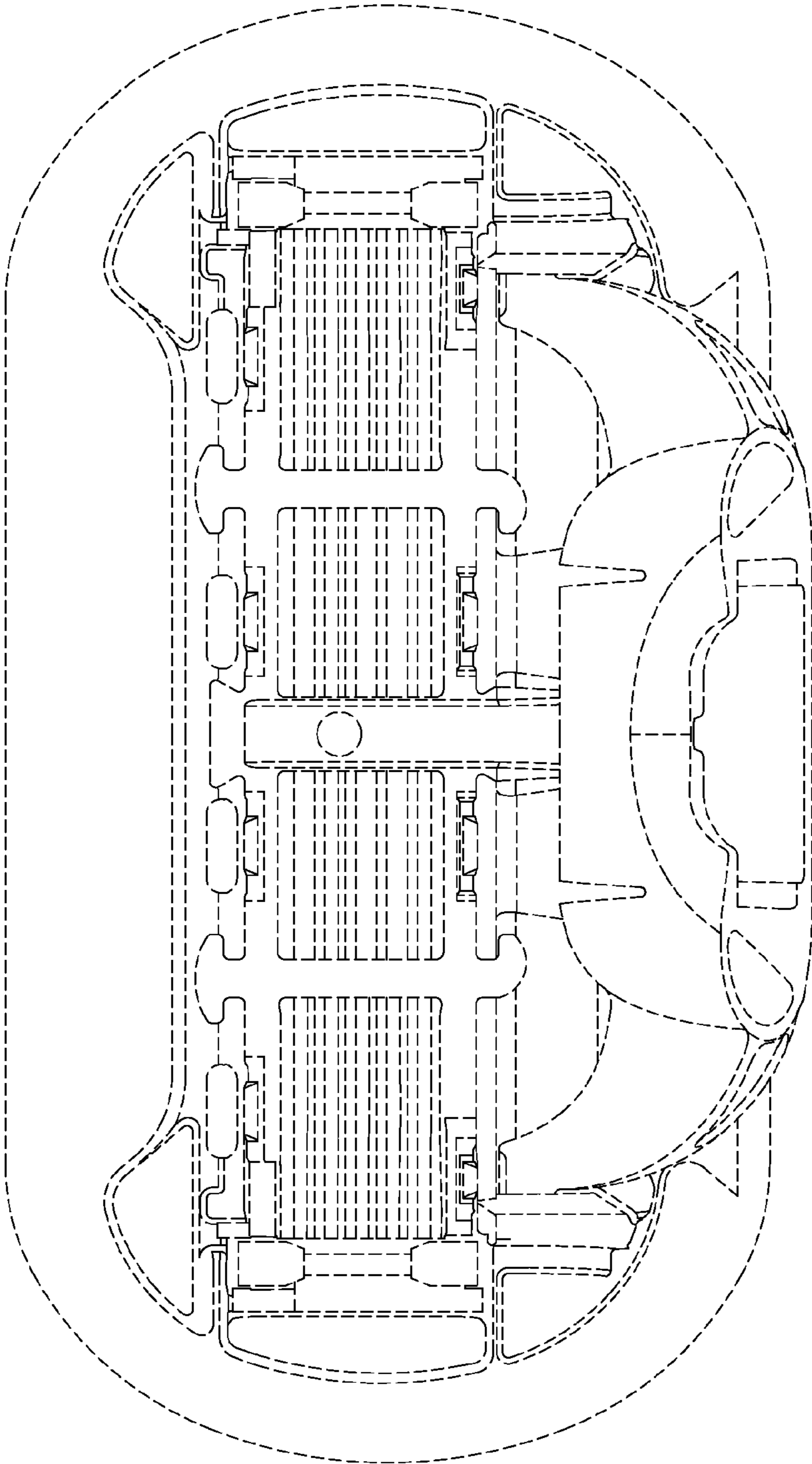

FIG. 3

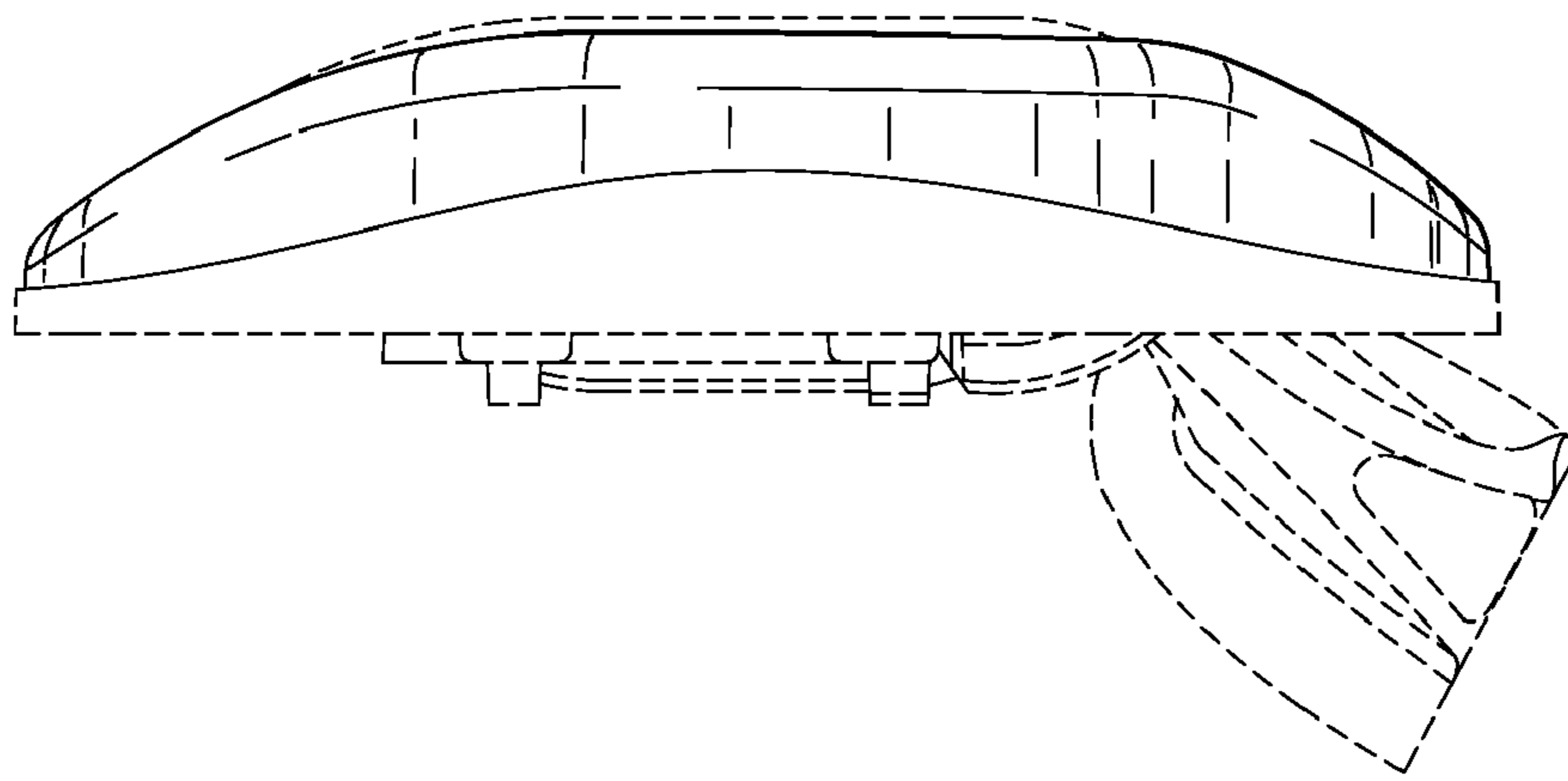

FIG. 5

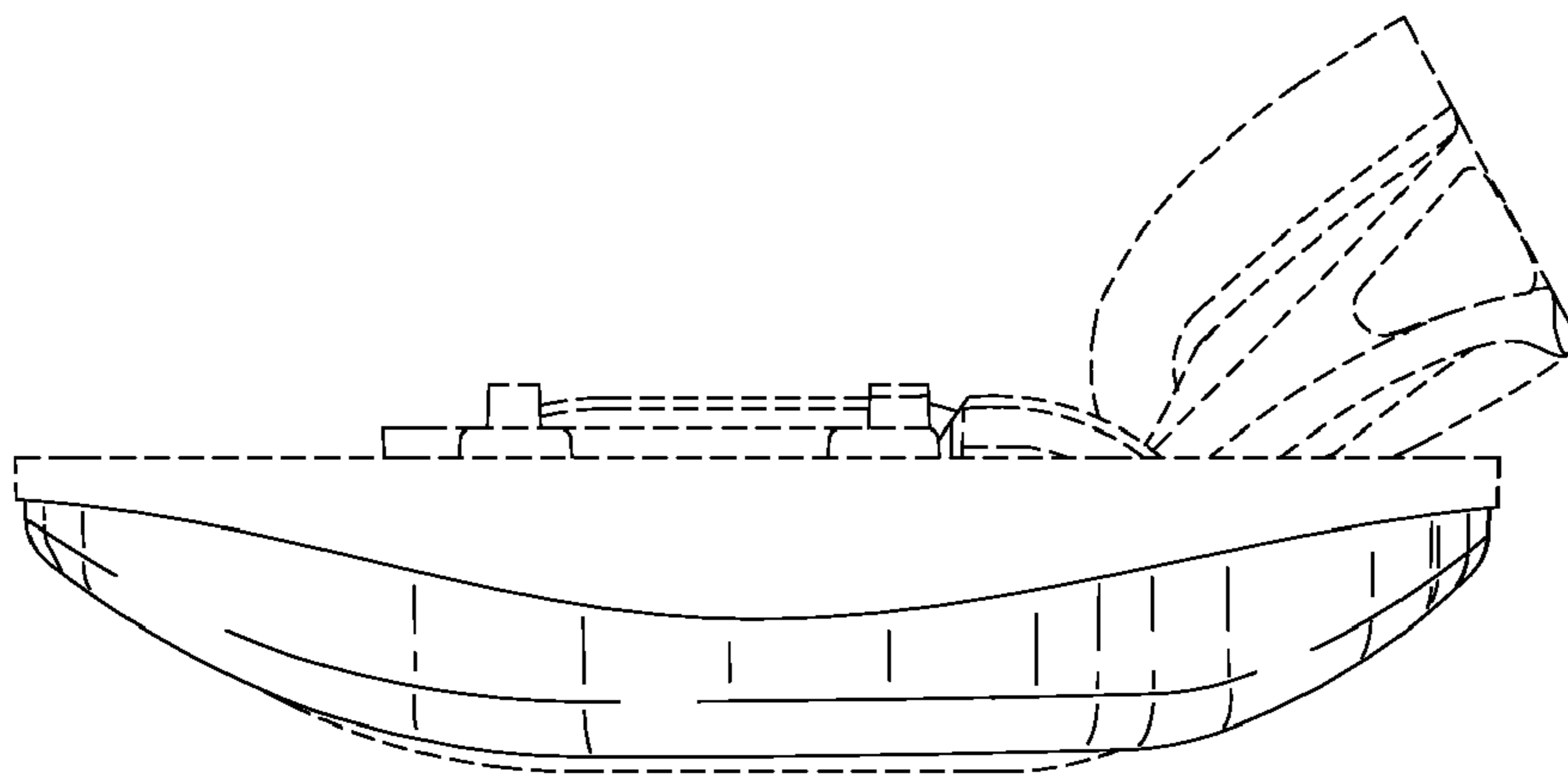

FIG. 4

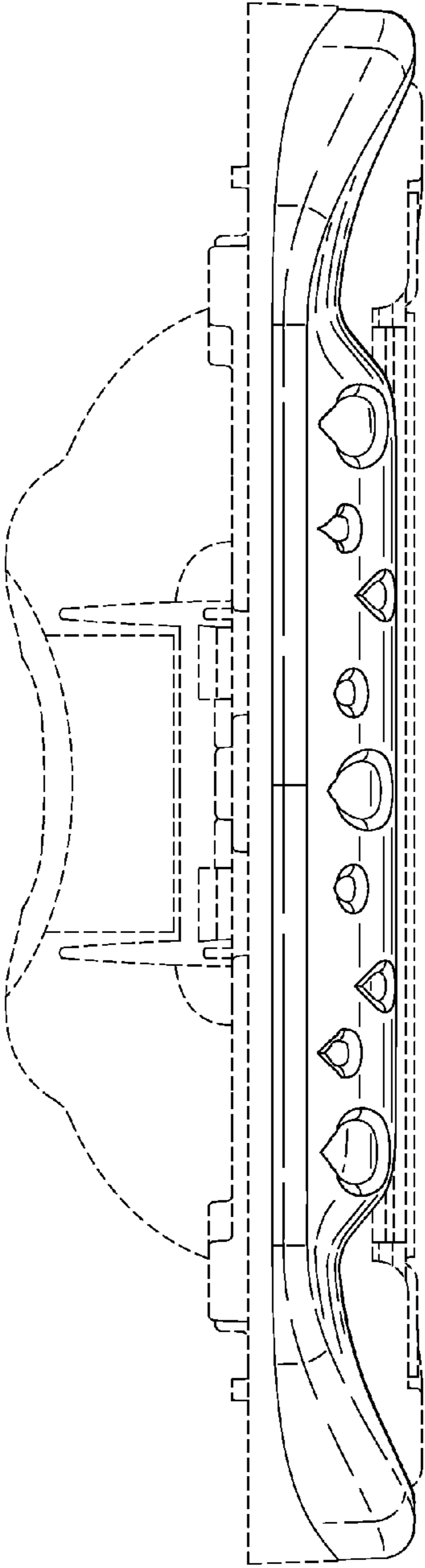

FIG. 6

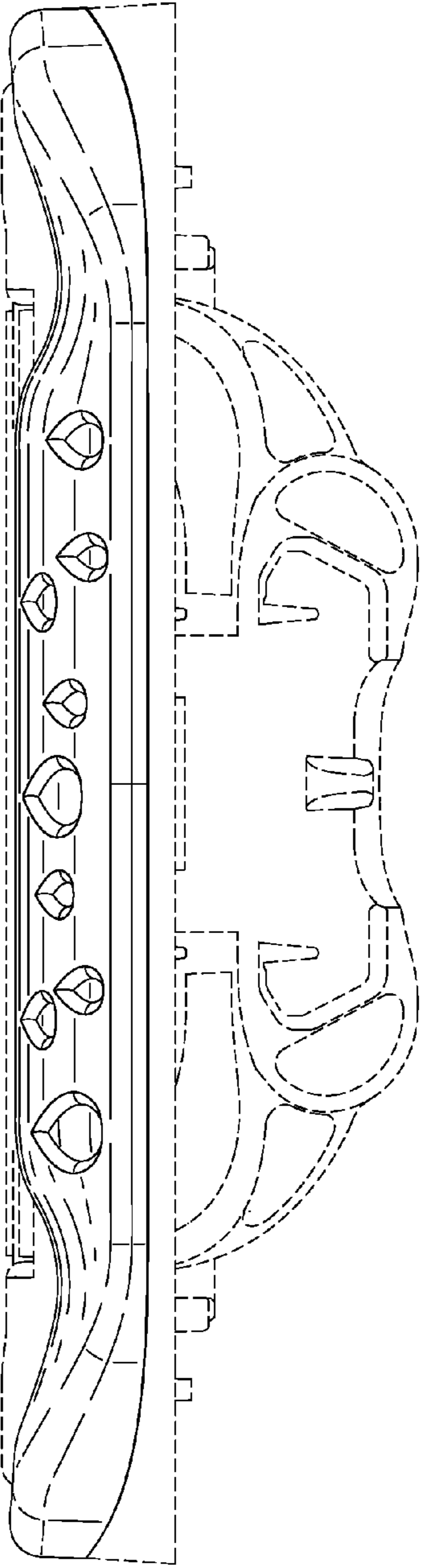

FIG. 7