



US00D622869S

(12) **United States Design Patent**
Bajrami

(10) **Patent No.:** **US D622,869 S**

(45) **Date of Patent:** **** Aug. 31, 2010**

(54) **PREFABRICATED BUILDING PART**

(75) Inventor: **Halil Bajrami**, Leatherhead (GB)

(73) Assignee: **D & T Catering Removals Ltd.**,
Leatherhead (GB)

(**) Term: **14 Years**

(21) Appl. No.: **29/351,714**

(22) Filed: **Dec. 10, 2009**

(30) **Foreign Application Priority Data**

Sep. 16, 2009 (EM) 001165690-0007

(51) **LOC (9) Cl.** **25-02**

(52) **U.S. Cl.** **D25/35**

(58) **Field of Classification Search** D25/35,
D25/38, 41-44, 102, 199, 126-135, 113,
D25/115-118; 52/602, 309.14, 309.9, 404.4,
52/405.4, 481.1, 582.1, 630, 783.11, 783.19,
52/800.1, 802.11

See application file for complete search history.

(56) **References Cited**

U.S. PATENT DOCUMENTS

- D83,067 S * 1/1931 Simone et al. D25/63
- 2,662,391 A * 12/1953 Neil 52/741.15
- 3,343,811 A * 9/1967 Kusel et al. 256/22
- 3,358,969 A * 12/1967 Horgan, Jr. et al. 256/24

- 3,818,660 A * 6/1974 Dillon 52/251
- D243,853 S * 3/1977 Ejchorszt D25/43
- 5,622,021 A * 4/1997 Bookout 52/582.1
- D468,835 S * 1/2003 Schiefelbein et al. D25/38
- D615,217 S * 5/2010 Steinkraus D25/126

* cited by examiner

Primary Examiner—T. Chase Nelson
Assistant Examiner—Eric L Goodman
(74) *Attorney, Agent, or Firm*—Pearne & Gordon LLP

(57) **CLAIM**

The ornamental design for the prefabricated building part, as shown and described.

DESCRIPTION

FIG. 1 is a perspective view of a prefabricated building part, of my new design;
FIG. 2 is an enlarged perspective view of the part of FIG. 1;
FIG. 3 is a top plan view thereof;
FIG. 4 is a right side elevational view, the left side elevational view being a mirror image thereof;
FIG. 5 is a front elevational view thereof; and,
FIG. 6 is a rear elevational view thereof.

The dotted-line shown in the drawings illustrates environmental matter and forms no part of the claimed design.

1 Claim, 1 Drawing Sheet

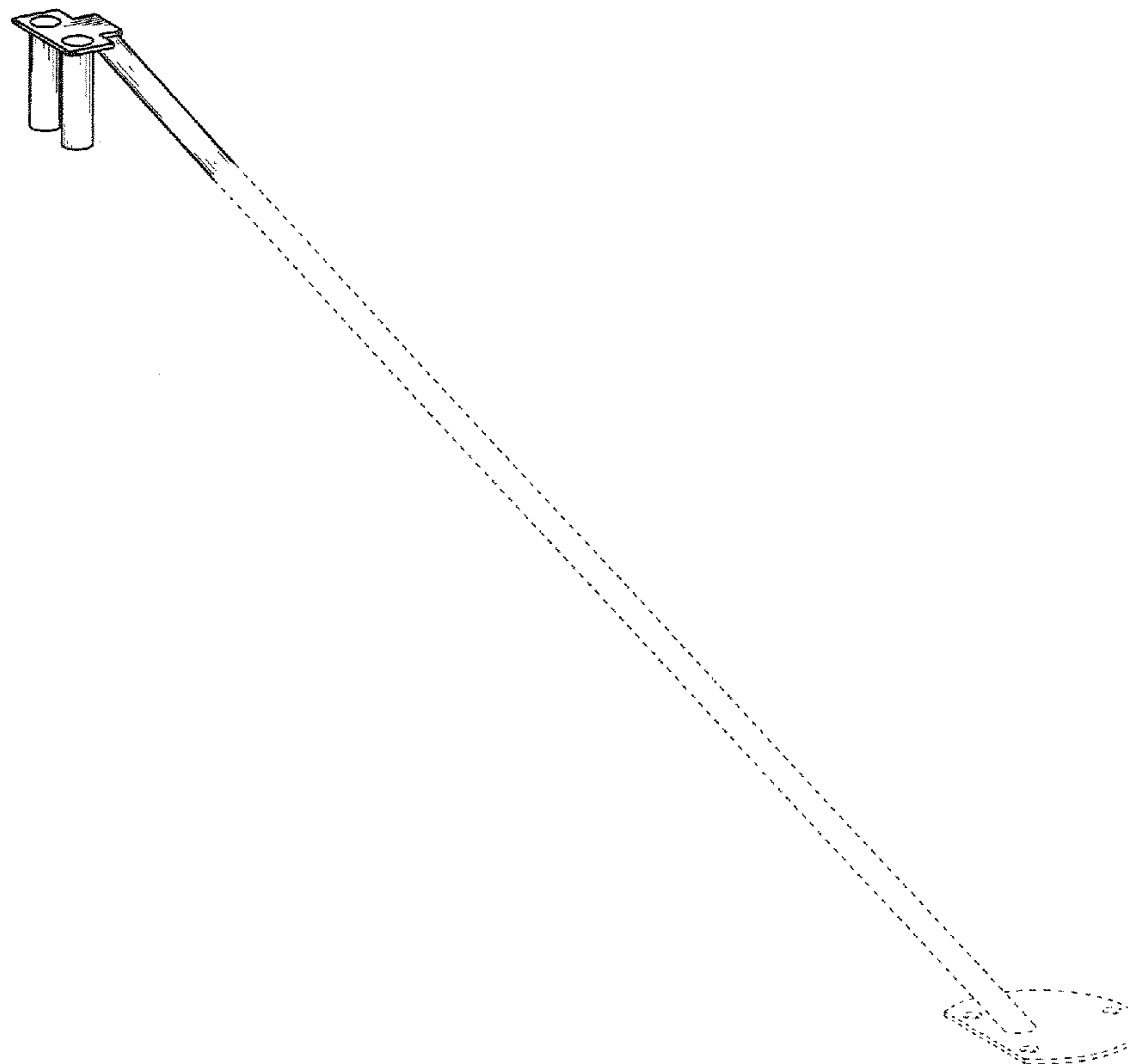

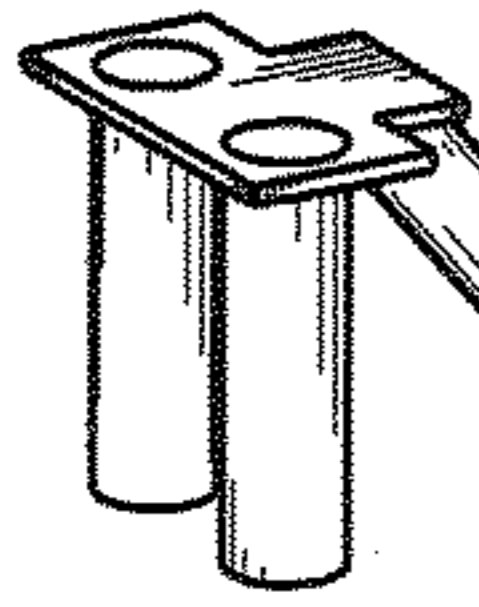

Fig. 1

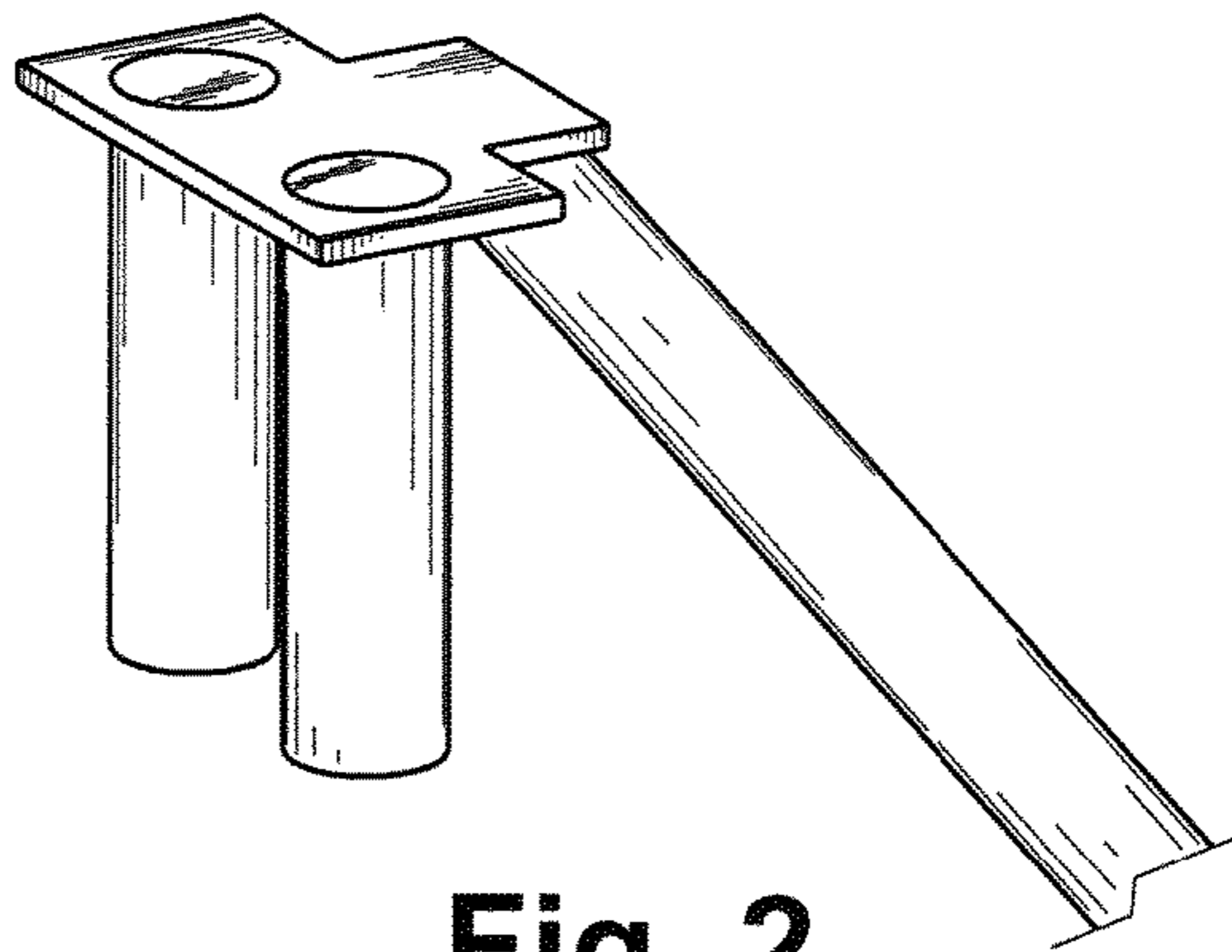

Fig. 2

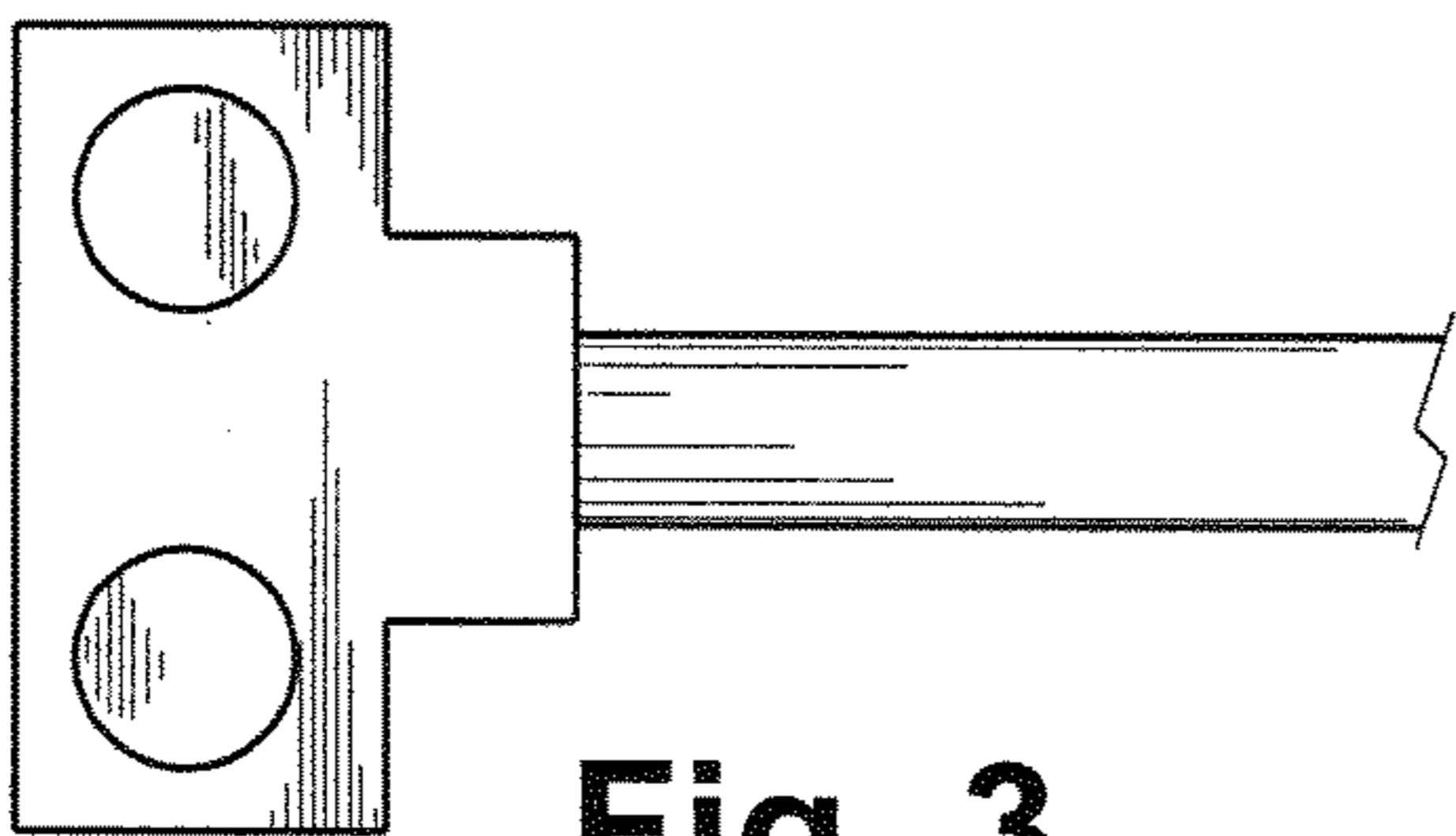

Fig. 3

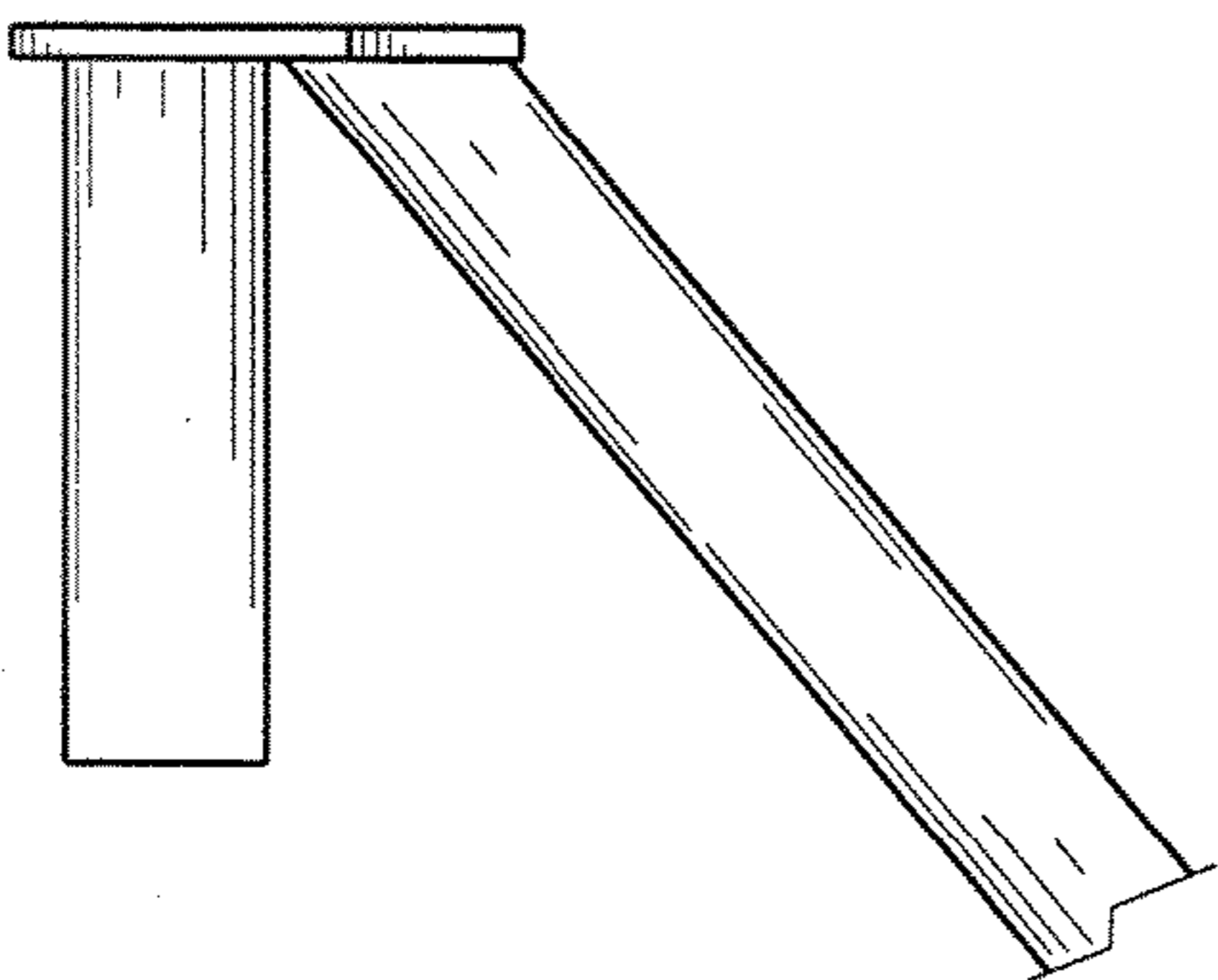

Fig. 4

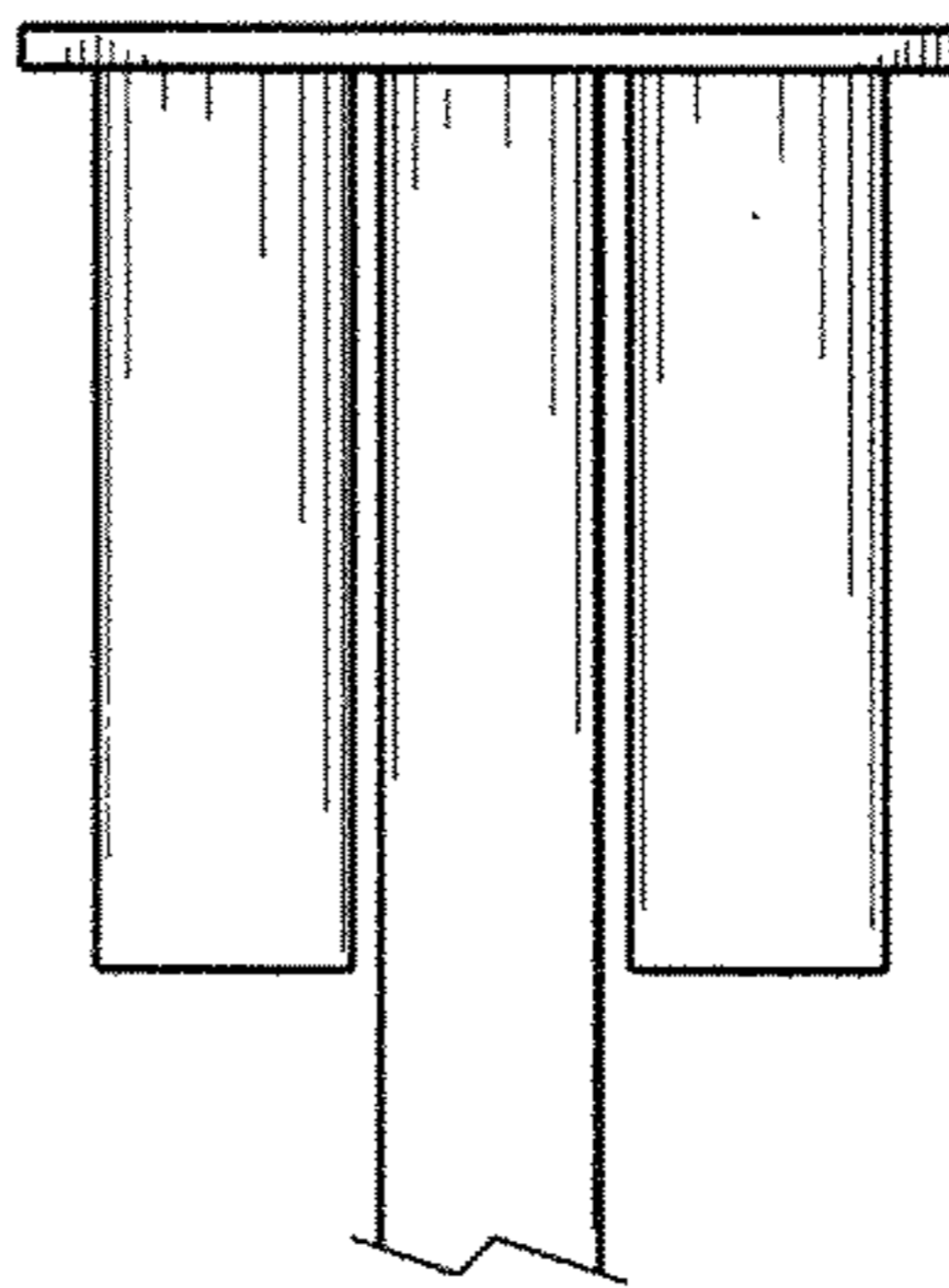

Fig. 5

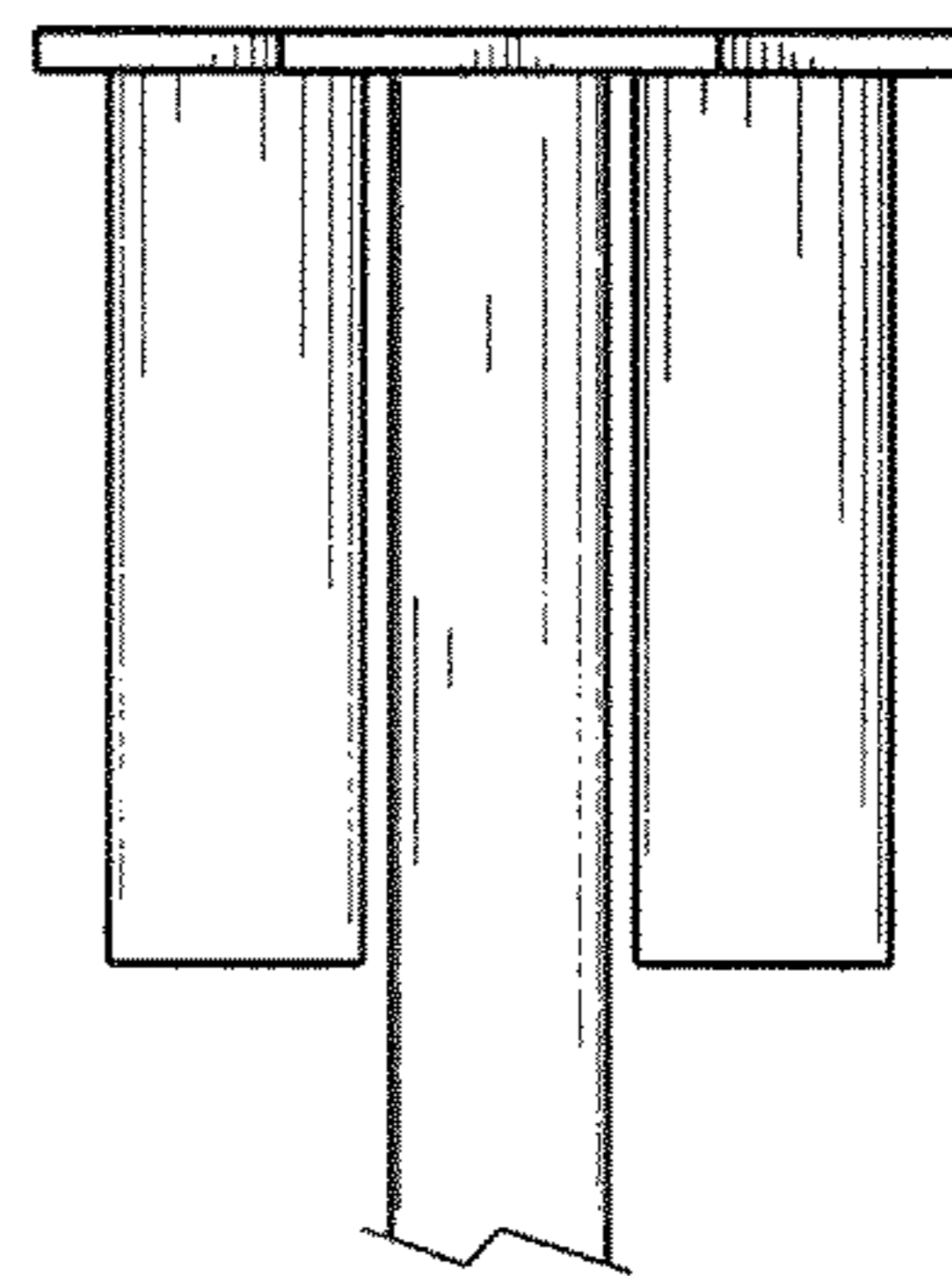

Fig. 6