



US00D622859S

(12) **United States Design Patent**
Feller et al.

(10) **Patent No.:** **US D622,859 S**

(45) **Date of Patent:** **** Aug. 31, 2010**

(54) **STERILIZER**

(75) Inventors: **Jürg Feller**, Hirzel (CH); **Urs Stadelmann**, Luzern (CH); **Britta Pukall**, Wädenswil (CH); **Therese Naef**, Wettingen (CH)

(73) Assignee: **Medela Holding AG**, Baar (CH)

(**) Term: **14 Years**

(21) Appl. No.: **29/356,807**

(22) Filed: **Mar. 3, 2010**

(30) **Foreign Application Priority Data**

Sep. 4, 2009 (WO) 511727501

(51) **LOC (9) Cl.** **24-01**

(52) **U.S. Cl.** **D24/217**

(58) **Field of Classification Search** D24/216–218;
D7/326; 422/24, 26, 27, 307; 206/207, 209,
206/5.1; 250/455.11; 219/521

See application file for complete search history.

(56) **References Cited**

U.S. PATENT DOCUMENTS

D100,858 S * 8/1936 Godshalk D24/217
2,467,337 A * 4/1949 Schnell D24/217
D176,310 S * 12/1955 Conlin et al. D24/217
D296,239 S * 6/1988 David D24/217

D305,261 S * 12/1989 Hobbs D24/217
D365,882 S * 1/1996 Allegre D24/217
D448,236 S * 9/2001 Murray D7/326
D487,517 S * 3/2004 Cudworth D24/217
7,422,722 B2 * 9/2008 Kim 422/24

* cited by examiner

Primary Examiner—T. Chase Nelson

Assistant Examiner—Anhdao Doan

(74) *Attorney, Agent, or Firm*—McDonnell Boehnen Hulbert & Berghoff LLP

(57) **CLAIM**

The ornamental design for a sterilizer, as shown and described.

DESCRIPTION

FIG. 1 is a first perspective view of a sterilizer of the present design;

FIG. 2 is a second perspective view thereof;

FIG. 3 is a front view thereof;

FIG. 4 is a back view thereof;

FIG. 5 is a right side view thereof;

FIG. 6 is a left side view thereof;

FIG. 7 is a top view thereof; and,

FIG. 8 is a bottom view thereof.

1 Claim, 8 Drawing Sheets

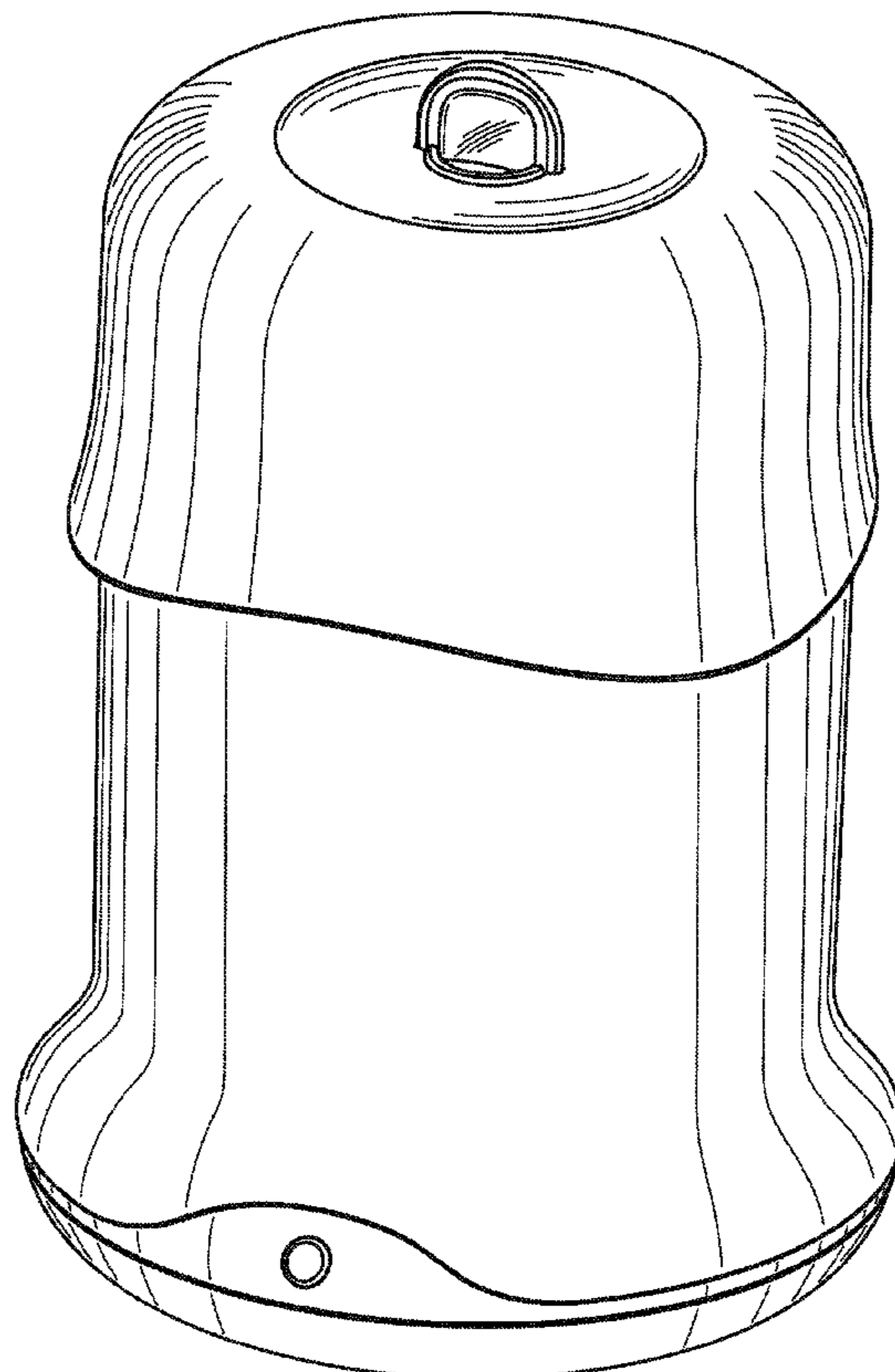

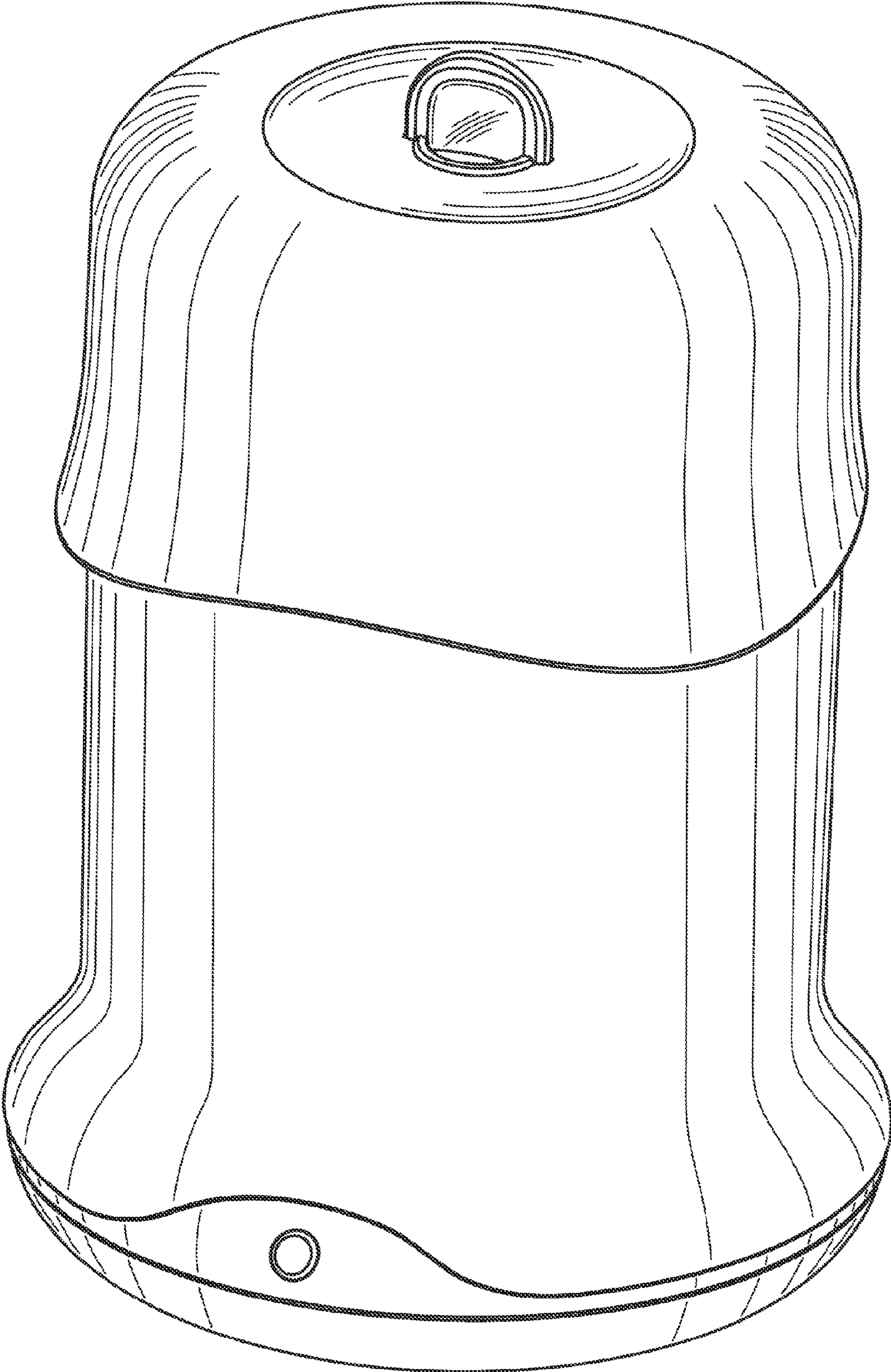

FIG. 1

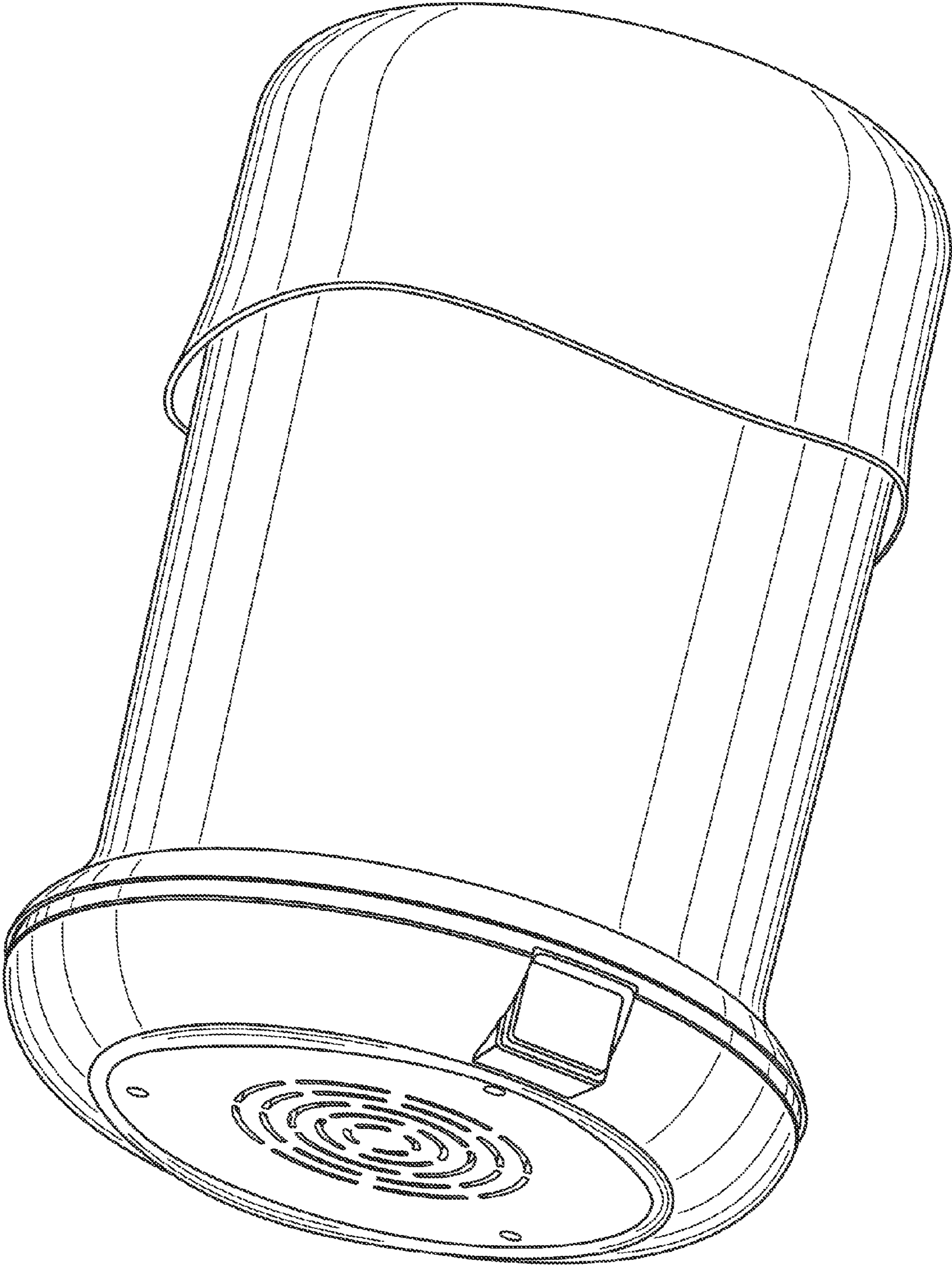

FIG. 2

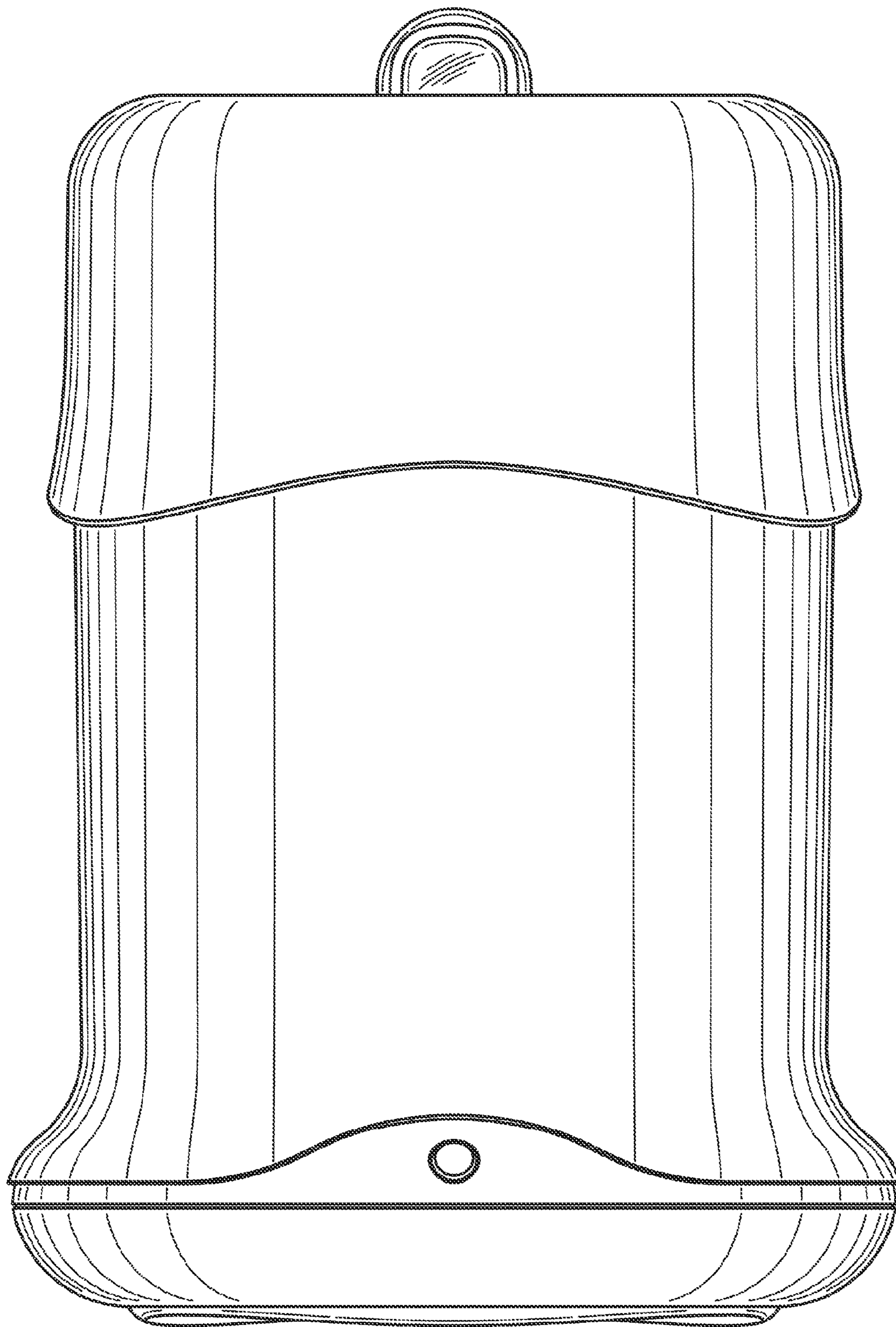

FIG. 3

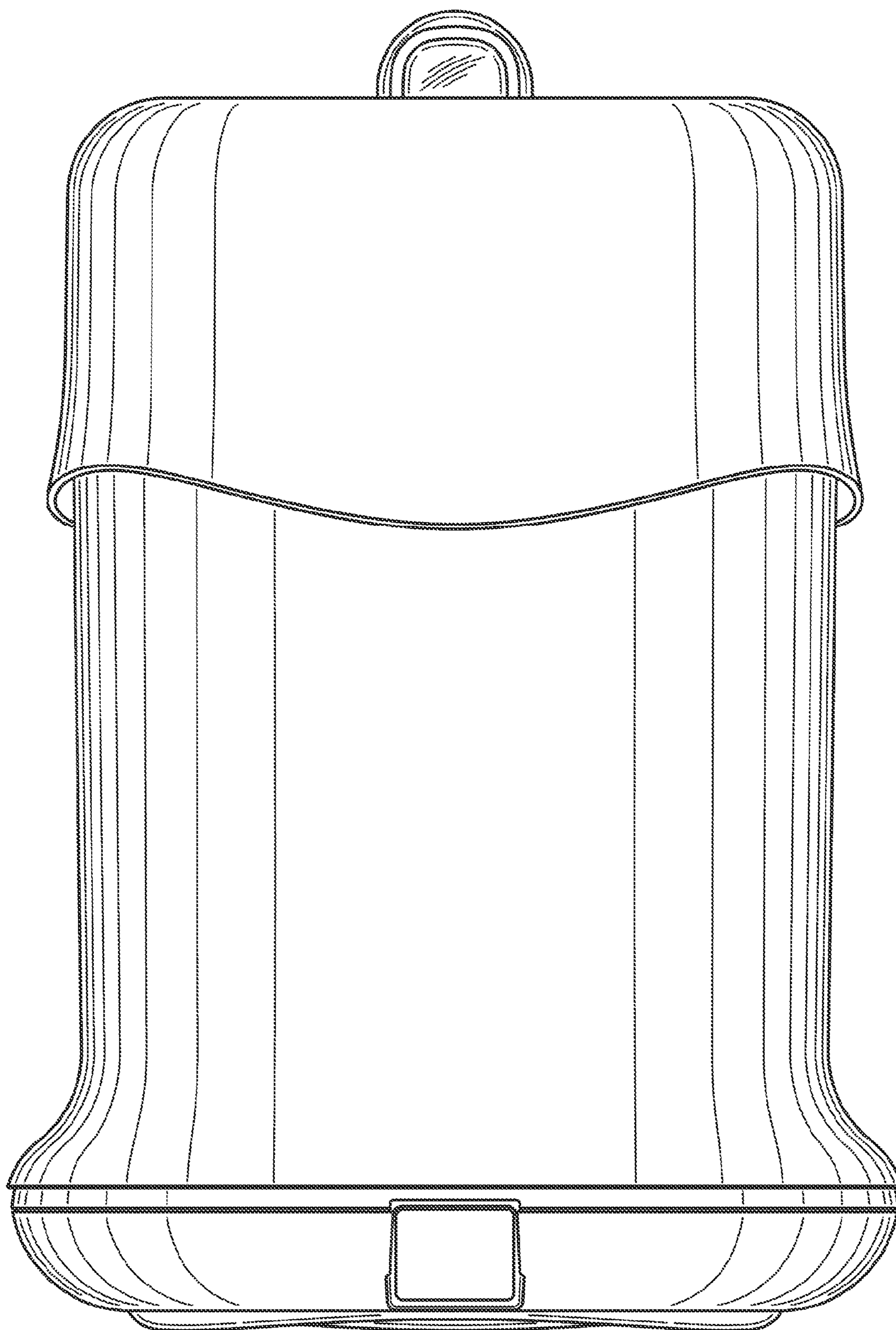

FIG. 4

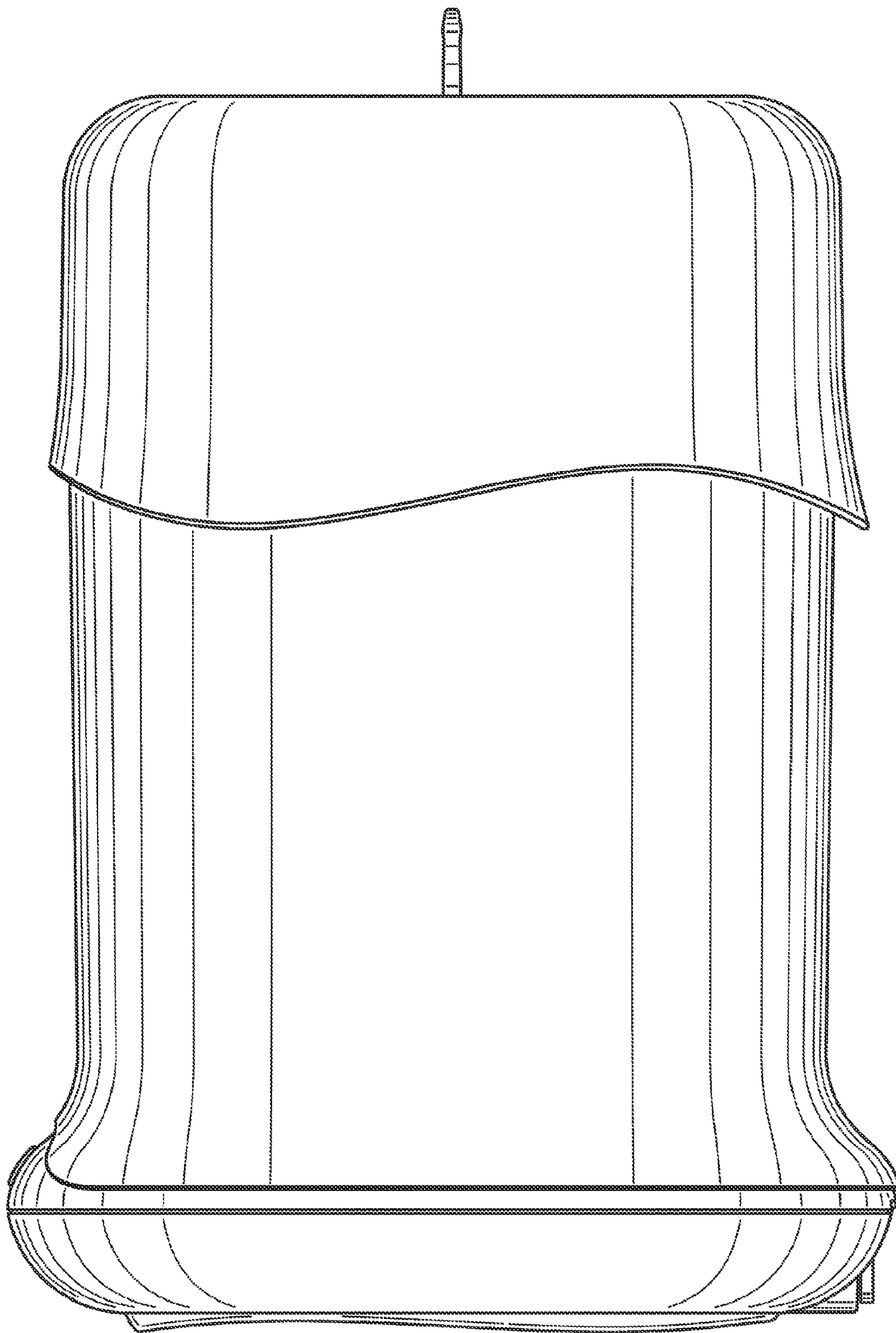

FIG. 5

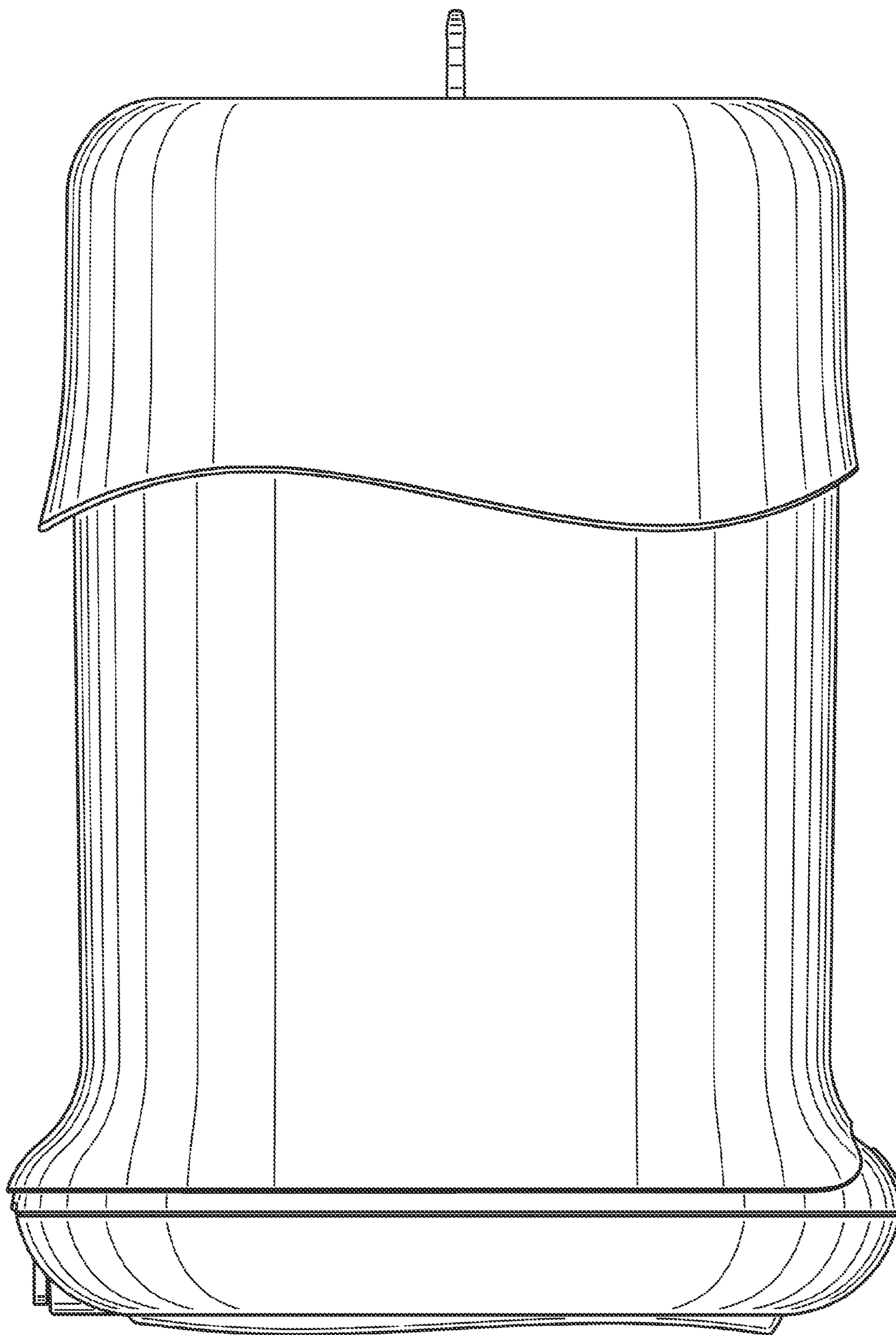

FIG. 6

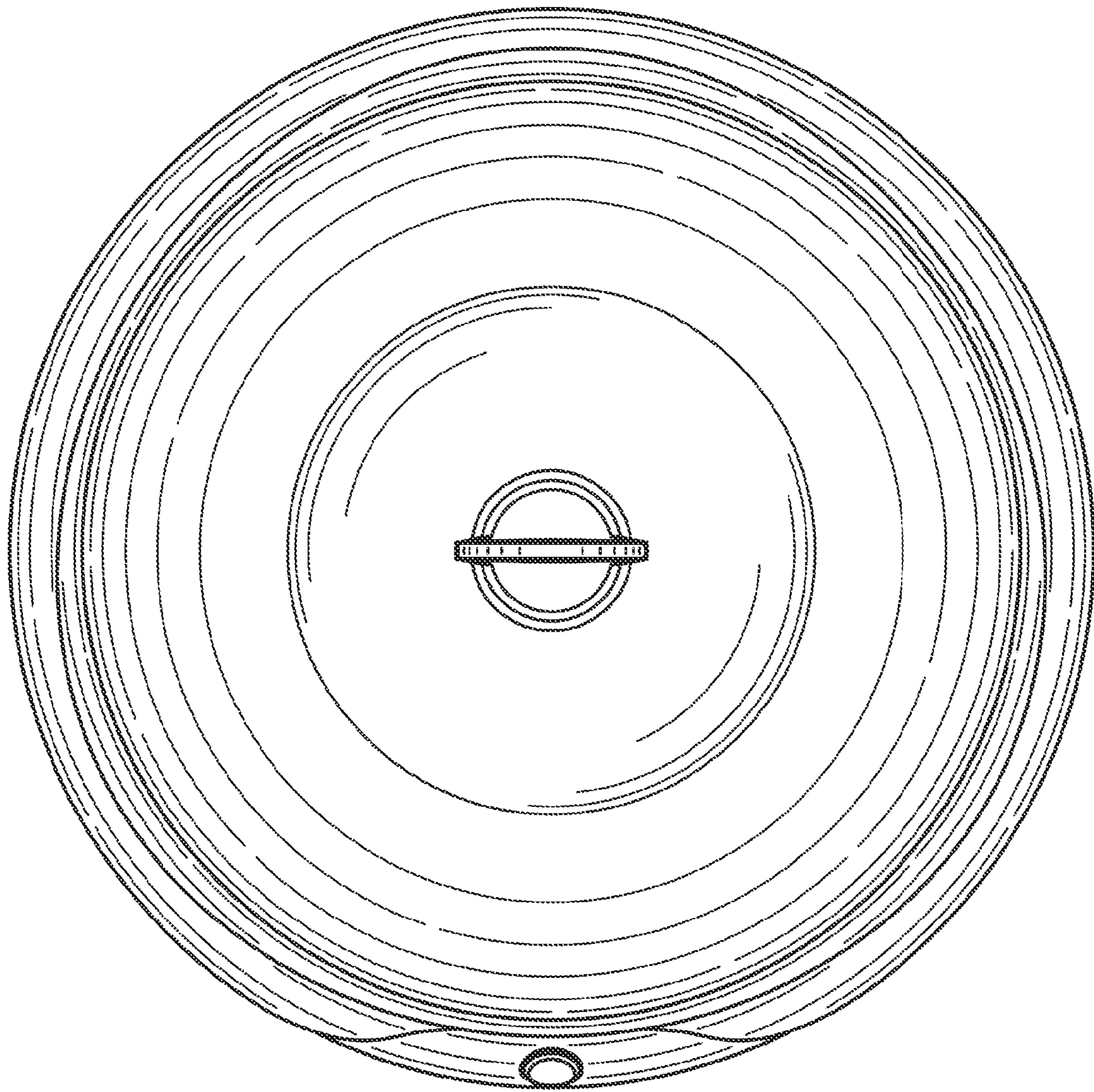

FIG. 7

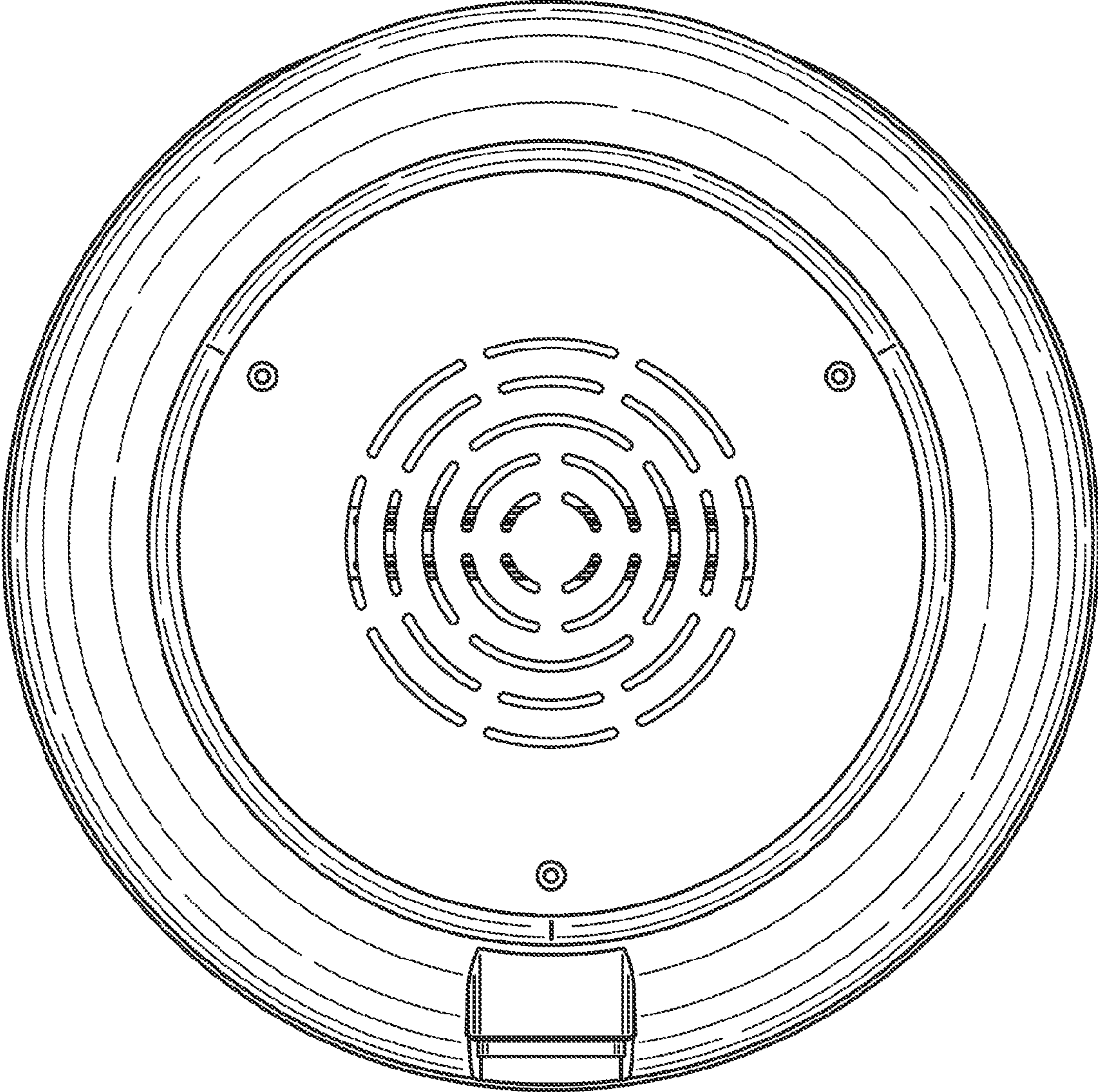

FIG. 8