



US00D622858S

(12) **United States Design Patent**
Jan

(10) **Patent No.:** **US D622,858 S**

(45) **Date of Patent:** **** Aug. 31, 2010**

(54) **FEET BATHTUB**

D608,454 S * 1/2010 Mai et al. D24/213
D612,509 S * 3/2010 Tran D24/204

(76) Inventor: **Danny Jan**, 3F, No. 443-1, Lunping S.
Rd., Changhua City, Changhua County
(TW)

* cited by examiner

(**) Term: **14 Years**

Primary Examiner—Cathron C Brooks

Assistant Examiner—Melanie Levy

(21) Appl. No.: **29/352,878**

(74) *Attorney, Agent, or Firm*—Alan Kamrath; Kamrath &
Associates PA

(22) Filed: **Dec. 29, 2009**

(57) **CLAIM**

(51) **LOC (9) Cl.** **24-04**

The ornamental design for a feet bathtub, as shown and
described.

(52) **U.S. Cl.** **D24/204**

(58) **Field of Classification Search** D24/200–205,
D24/212–213; D28/56, 61; D6/336, 495;
601/6, 15, 16, 64, 157–158, 30–32; 607/44;
4/622, 547.1

DESCRIPTION

See application file for complete search history.

FIG. 1 is a perspective view of a feet bathtub showing my
design;

FIG. 2 is a front elevational view thereof;

FIG. 3 is a rear elevational view thereof;

FIG. 4 is a left side elevational view thereof;

FIG. 5 is a right side elevational view thereof;

FIG. 6 is a top plan view thereof;

FIG. 7 is a bottom plan view thereof; and,

FIG. 8 is an additional perspective view thereof, showing an
application of the feet bathtub.

The broken lines shown in the drawings represent unclaimed
portions of the design and form no part thereof.

(56) **References Cited**

U.S. PATENT DOCUMENTS

D450,390 S *	11/2001	Tran	D24/213
D457,018 S *	5/2002	Park	D6/495
6,503,212 B2 *	1/2003	Park	601/158
D549,999 S *	9/2007	Fugate et al.	D6/500
D569,986 S *	5/2008	Ton	D24/204
D571,018 S *	6/2008	Ton et al.	D24/204
D571,961 S *	6/2008	Nguyen	D28/56
D574,502 S *	8/2008	Ton	D24/204
D588,707 S *	3/2009	Mai et al.	D24/213
D592,312 S *	5/2009	Cheng	D24/204
D600,815 S *	9/2009	Ton	D24/204

1 Claim, 8 Drawing Sheets

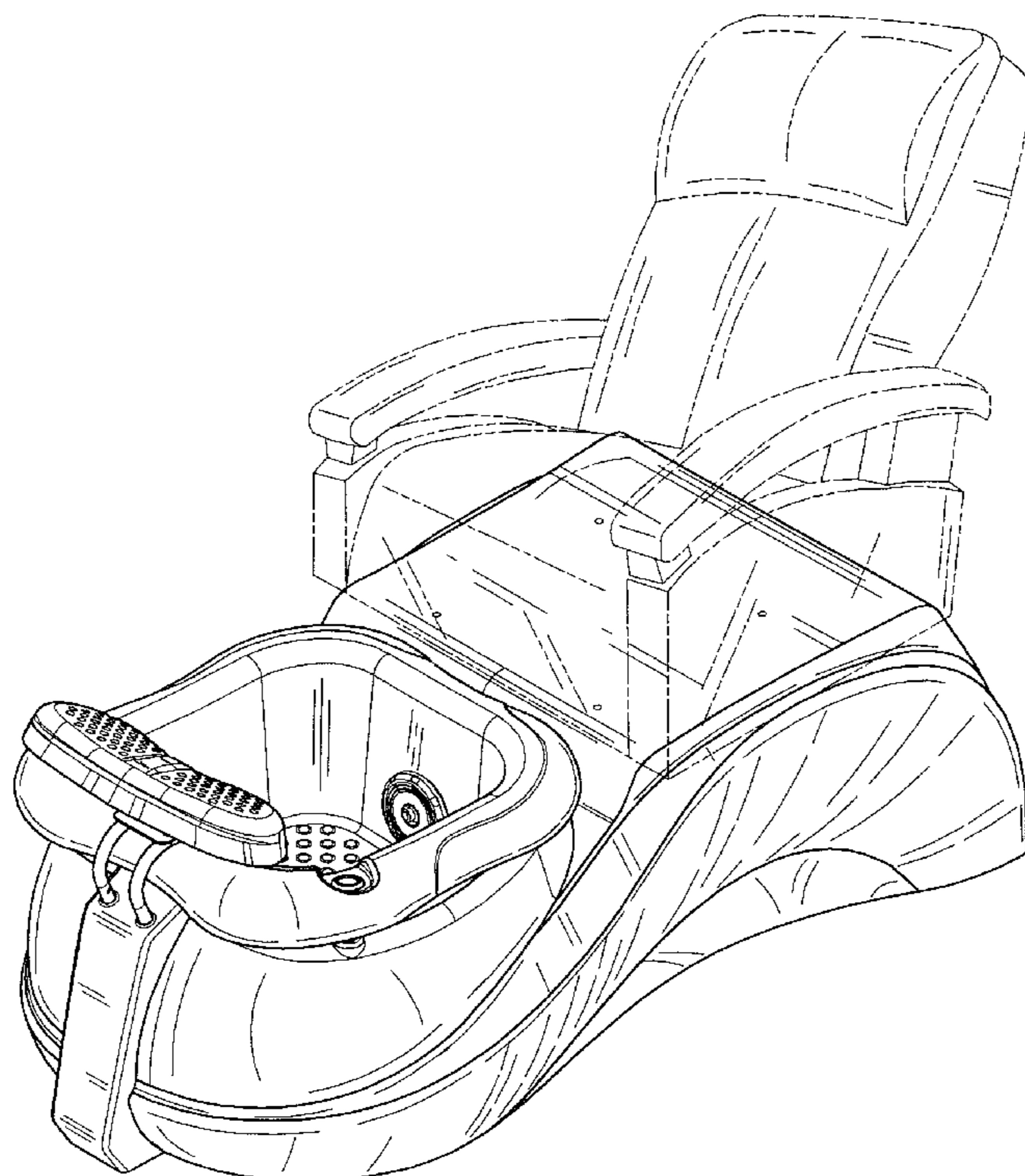

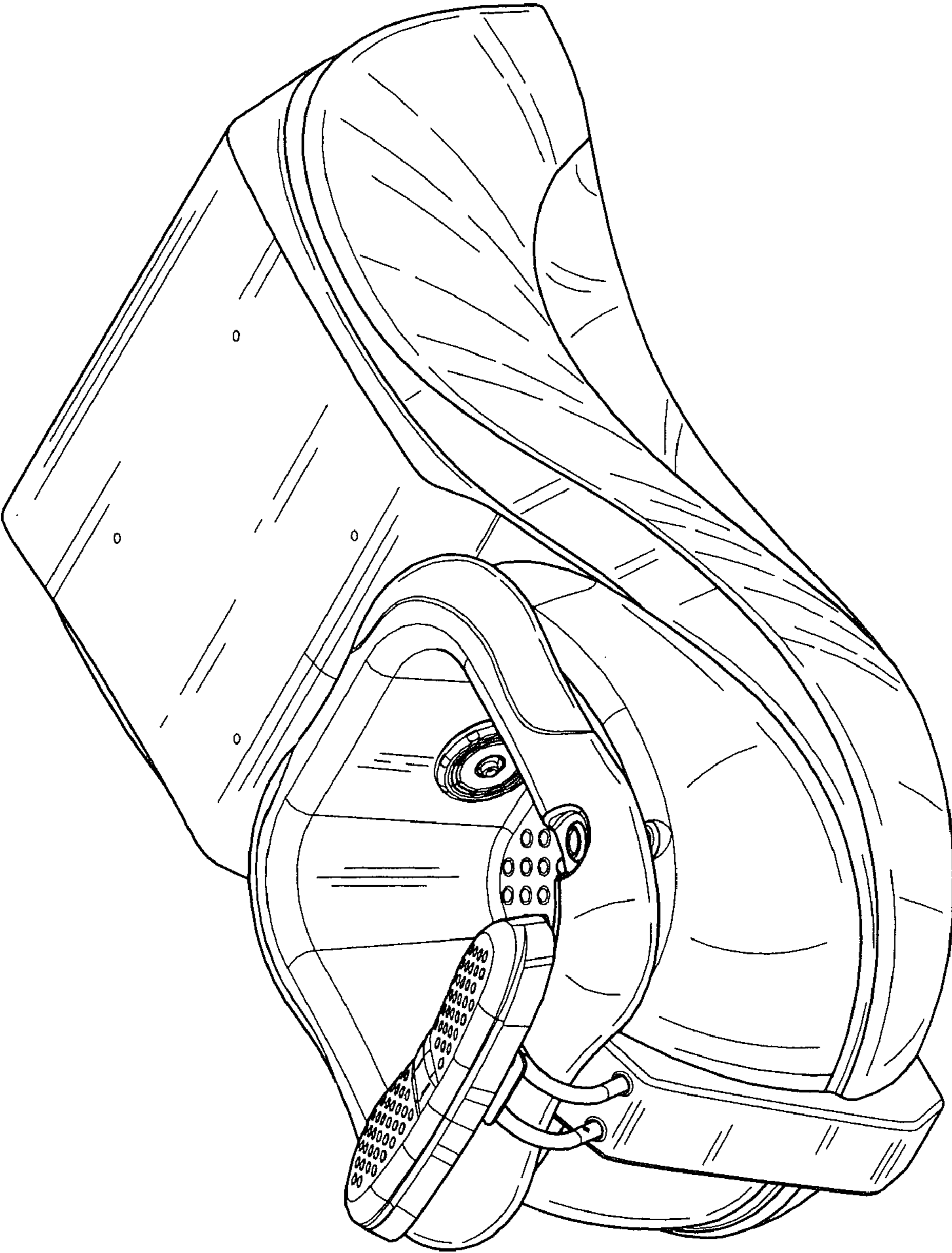

FIG. 1

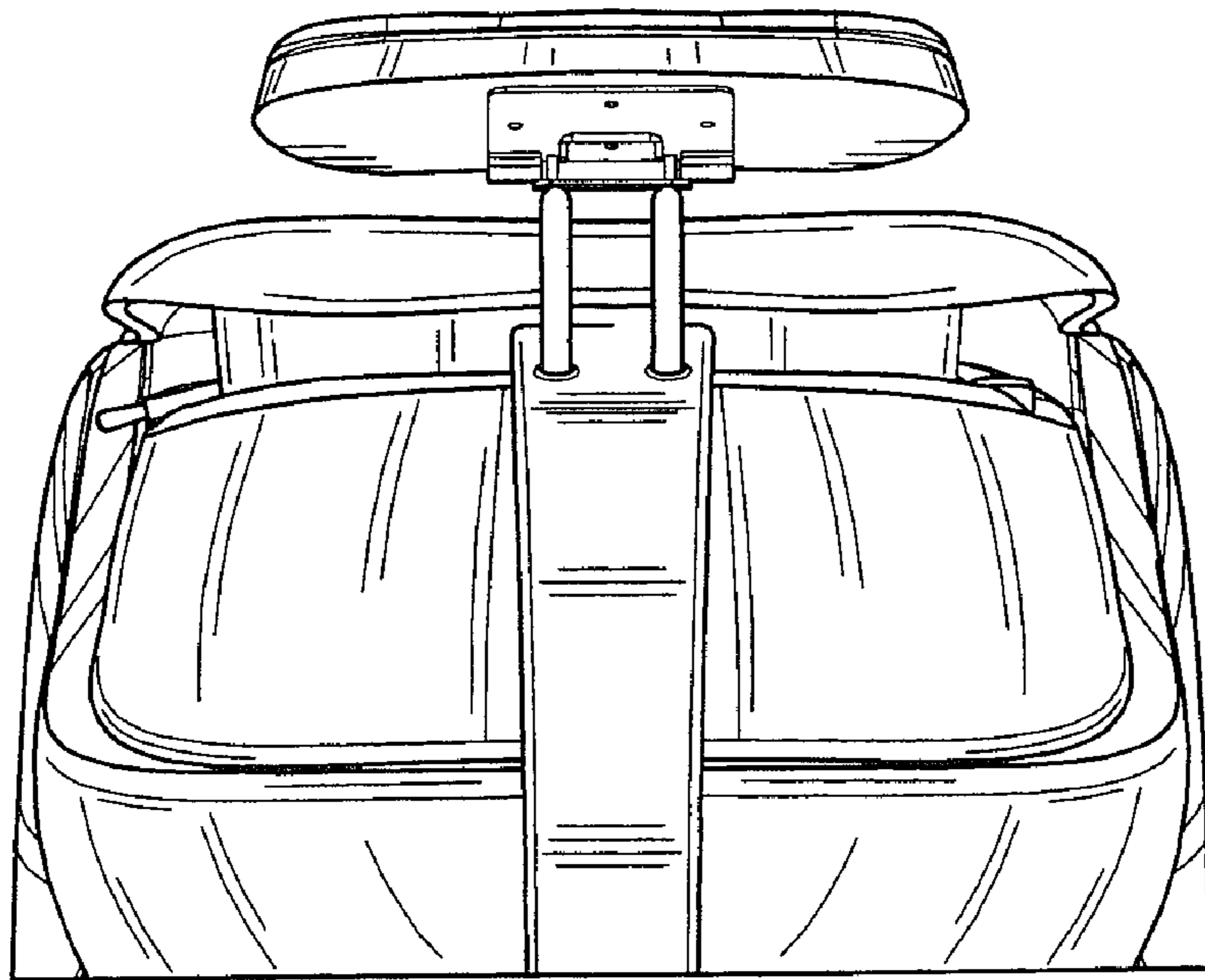

FIG. 2

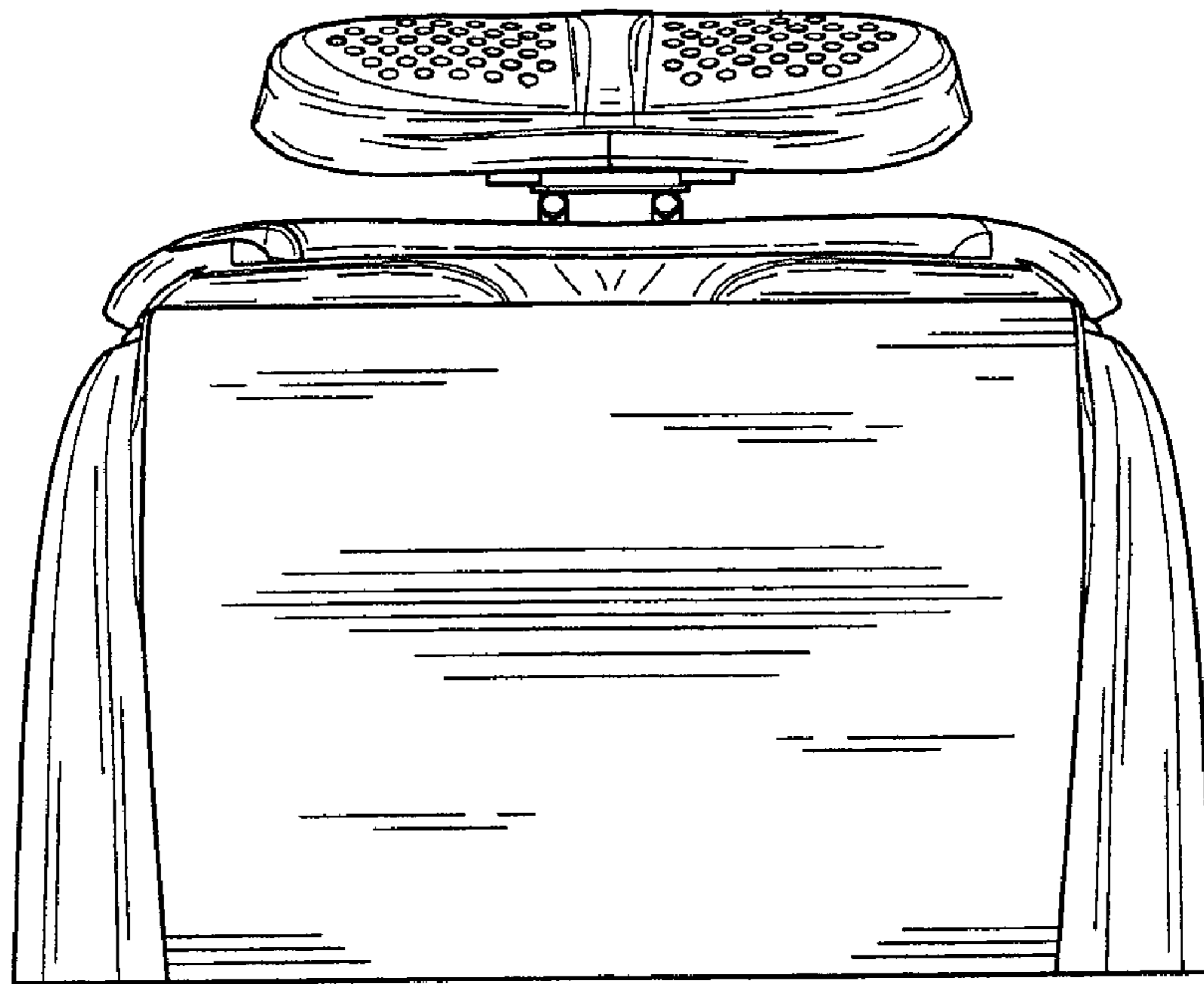

FIG. 3

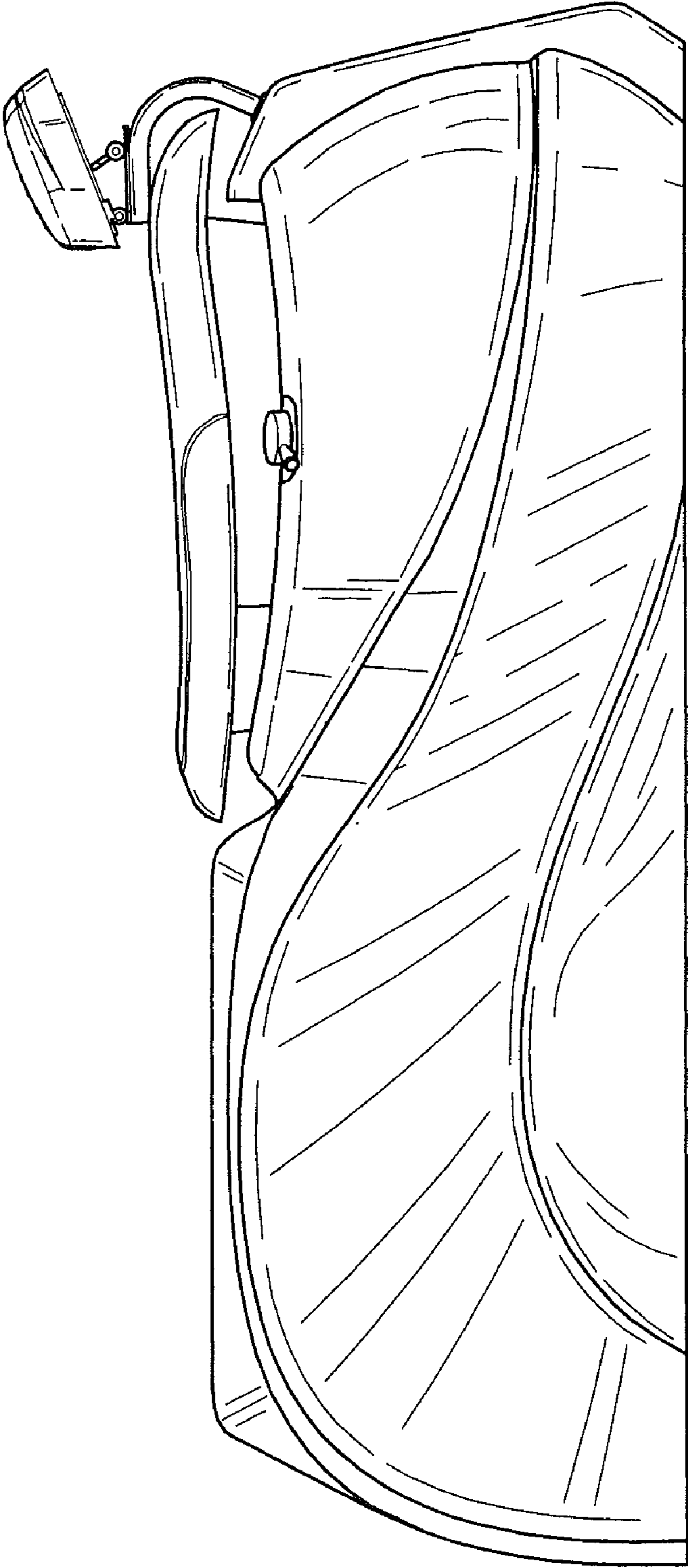

FIG. 4

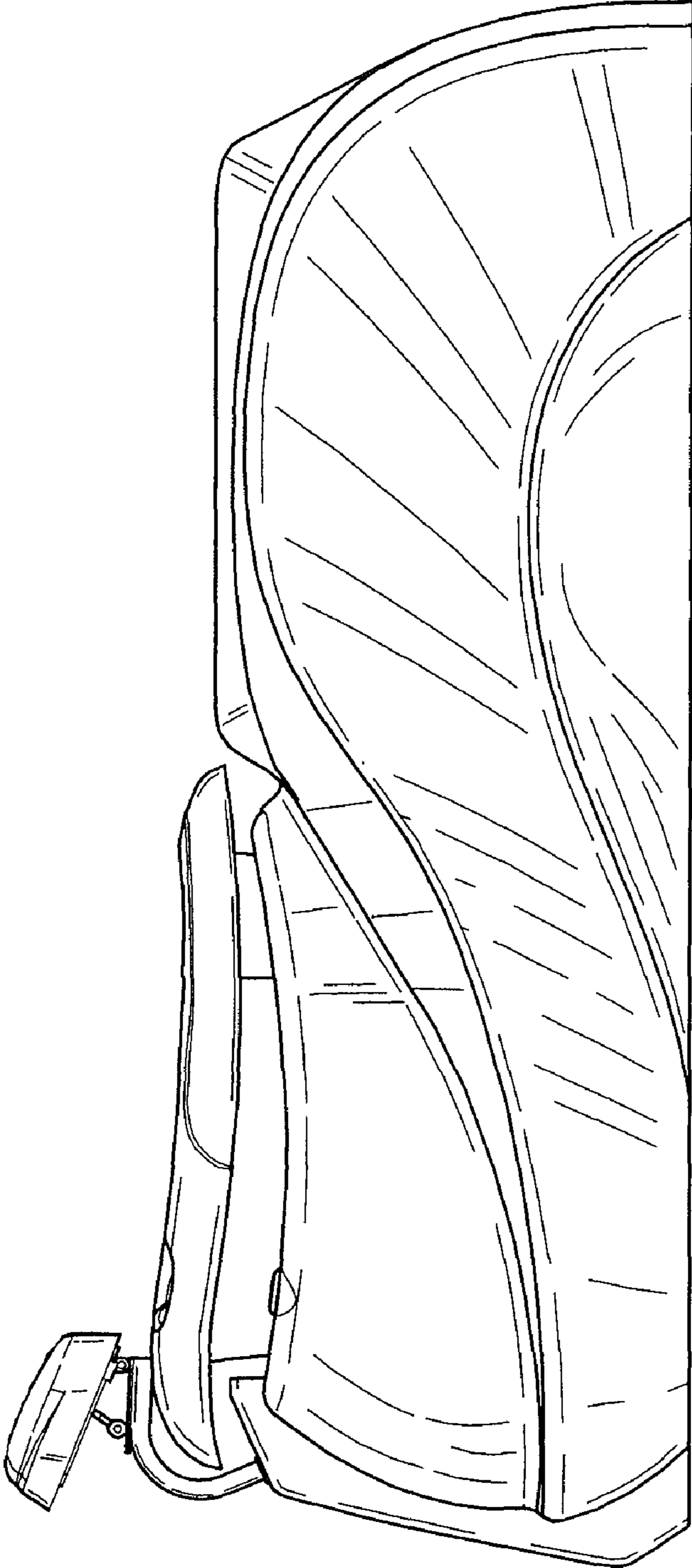

FIG. 5

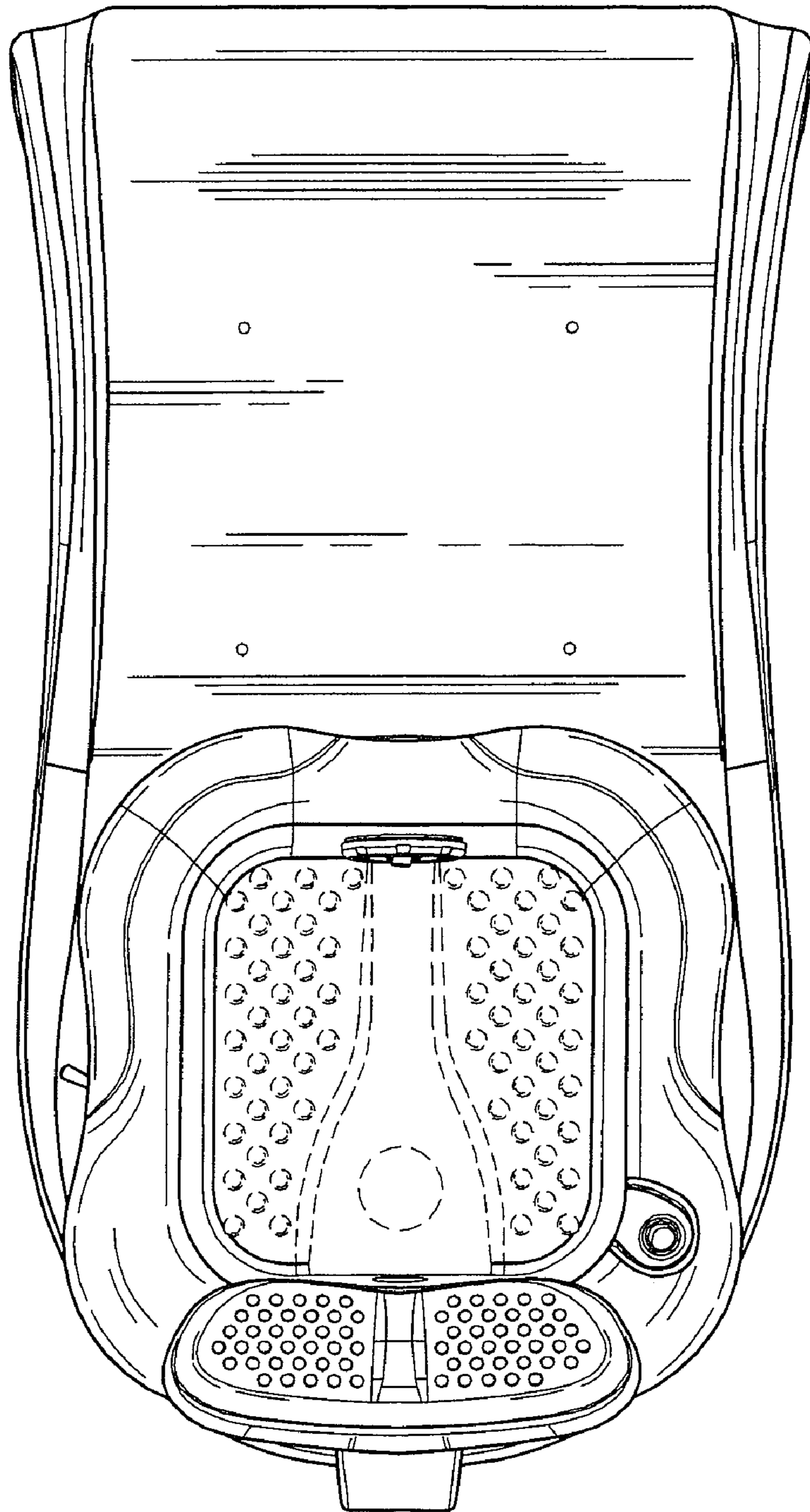

FIG. 6

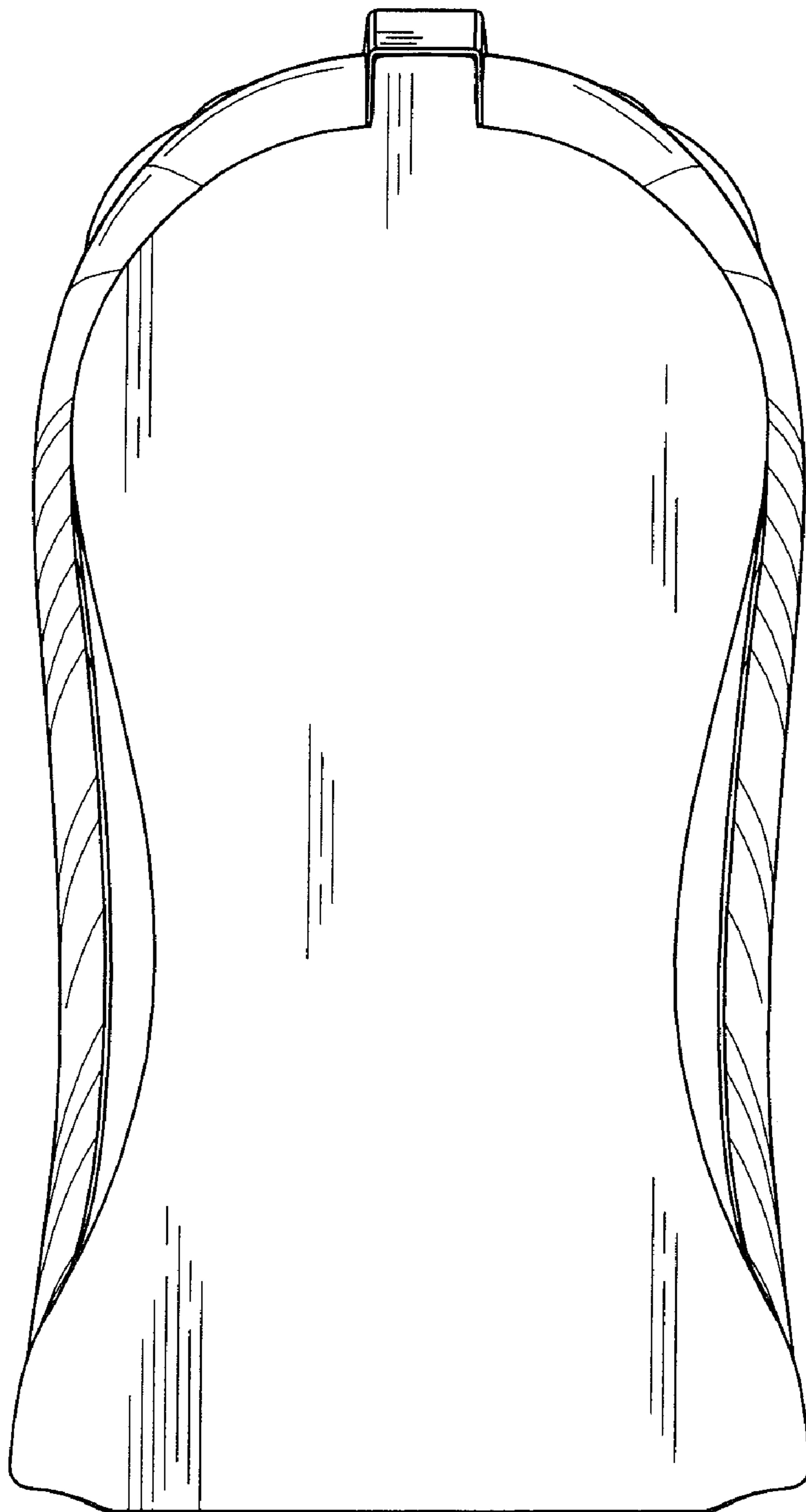

FIG. 7

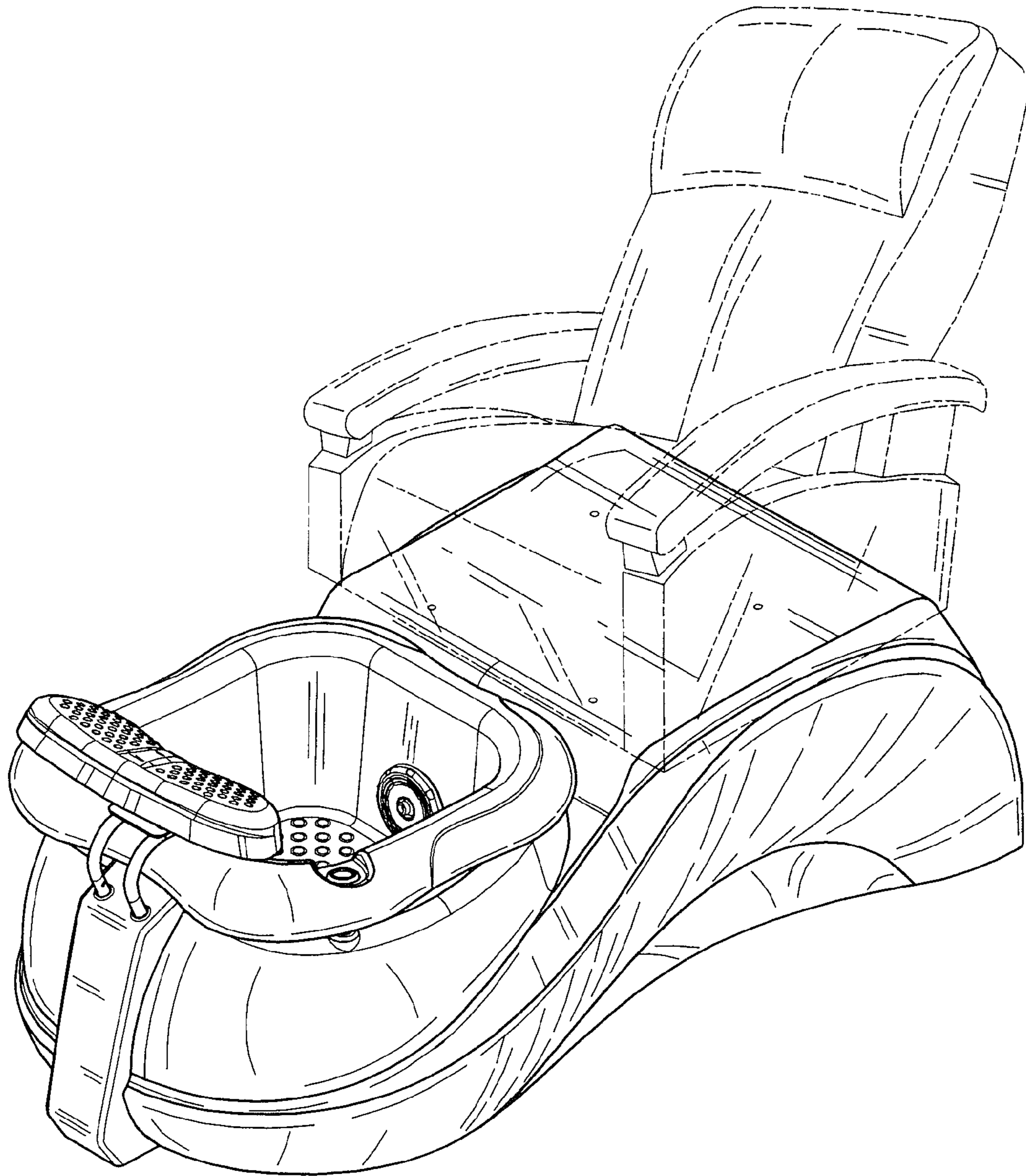

FIG. 8