



US00D622828S

(12) **United States Design Patent**
Soulier

(10) **Patent No.:** **US D622,828 S**

(45) **Date of Patent:** **** Aug. 31, 2010**

(54) **PLUMBING FIXTURE**

(75) Inventor: **Jean-Hugues Soulier**, Paris (FR)

(73) Assignee: **Kohler France SAS**, Paris (FR)

(**) Term: **14 Years**

(21) Appl. No.: **29/356,949**

(22) Filed: **Mar. 4, 2010**

Related U.S. Application Data

(62) Division of application No. 29/320,614, filed on Jun. 30, 2008, now Pat. No. Des. 613,836.

(30) **Foreign Application Priority Data**

Jan. 4, 2008	(EM)	000853338-0002
Jan. 4, 2008	(EM)	000853338-0003
Jan. 4, 2008	(EM)	000853338-0004

(51) **LOC (9) Cl.** **23-02**

(52) **U.S. Cl.** **D23/295**

(58) **Field of Classification Search** D23/273-274,
D23/295-301, 309; 4/663-664, 300, 329,
4/353, 420, 443, 449, 902

See application file for complete search history.

(56) **References Cited**

U.S. PATENT DOCUMENTS

D508,116 S	8/2005	Tani et al.
D592,293 S	5/2009	Maruhashi

OTHER PUBLICATIONS

Jacob Delafon. Abattant Toilette/water closet. Jacob Delafon online catalog.

Eljer. "Valencia Bidet". Model No. 101-1250. Eljer catalog.

Primary Examiner—Robert A Delehanty

(74) *Attorney, Agent, or Firm*—Quarles & Brady LLP

(57) **CLAIM**

The ornamental design for a plumbing fixture, as shown and described.

DESCRIPTION

FIG. 1 is a left, top, front perspective view of a plumbing fixture according to my new design;

FIG. 2 is a top plan view thereof;

FIG. 3 is a left side elevational view thereof, the right side elevational view thereof being a mirror image of the left side shown;

FIG. 4 is a front elevational view thereof;

FIG. 5 is a rear elevational view thereof; and,

FIG. 6 is a bottom plan view thereof.

The broken line representations in the figures are for the purpose of illustration only, and form no part of the claimed design.

In a preferred embodiment, the nature of this product is as a plumbing fixture in the form of a wall-hangable bidet or toilet.

1 Claim, 4 Drawing Sheets

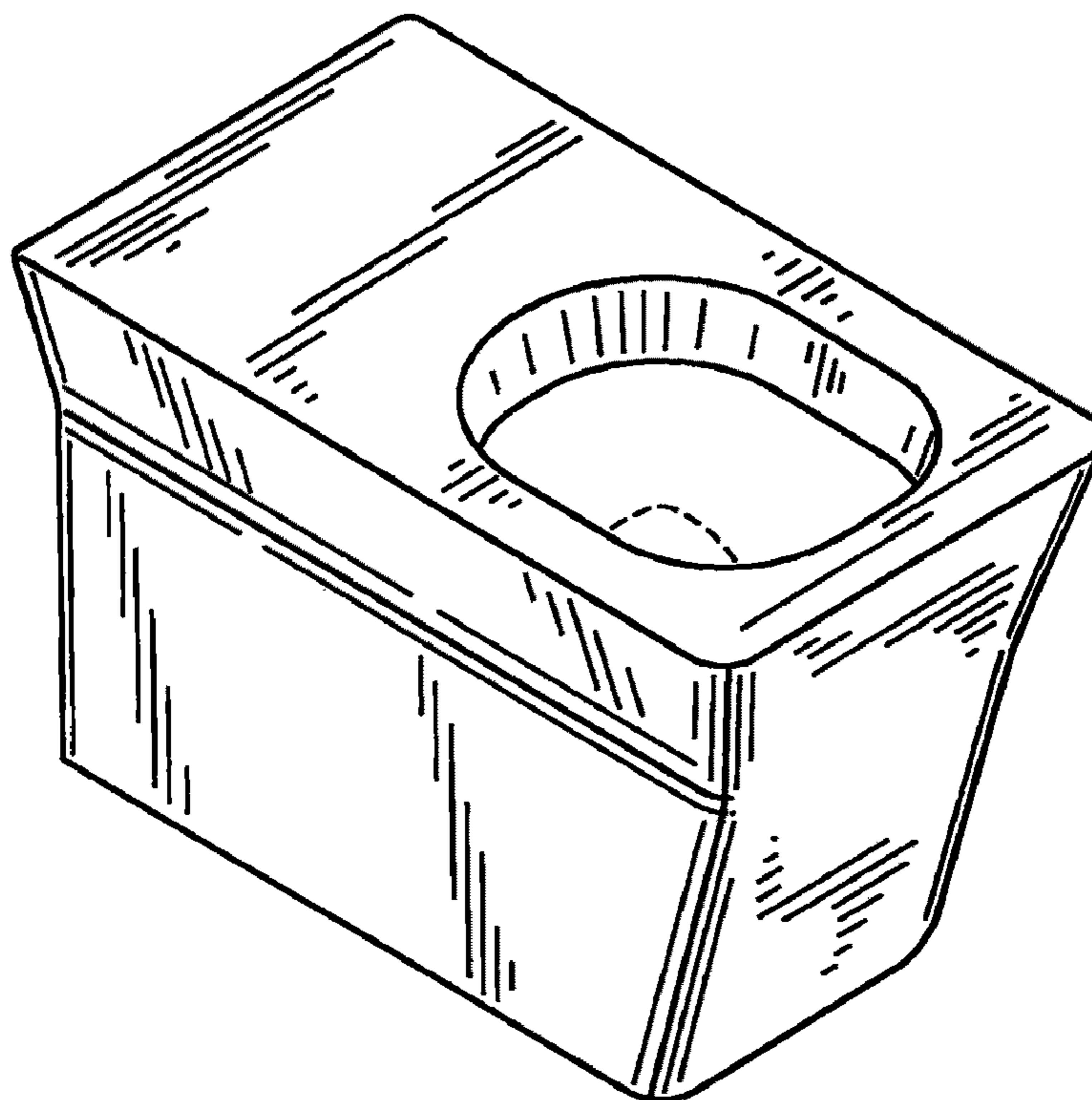

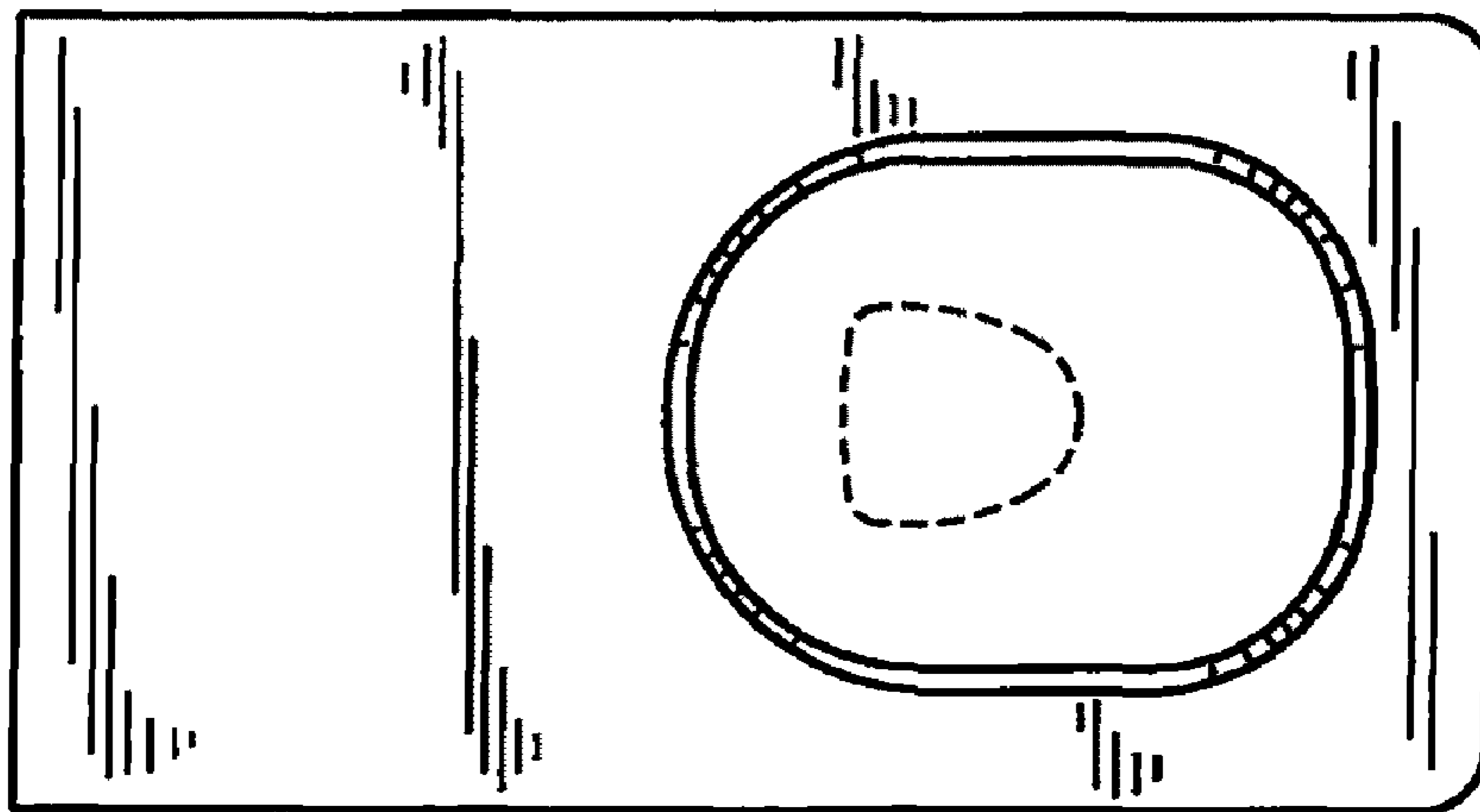
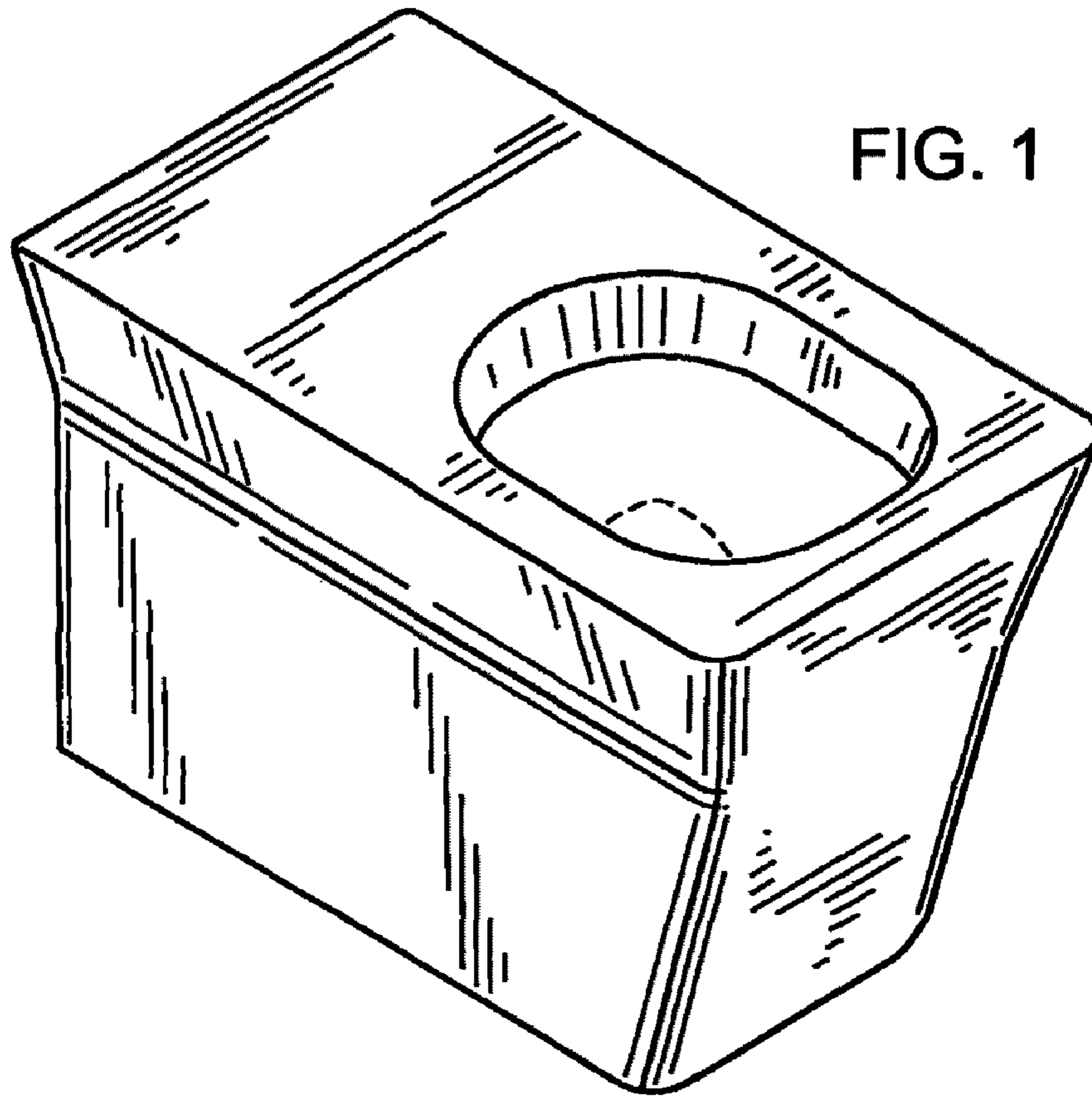

FIG. 2

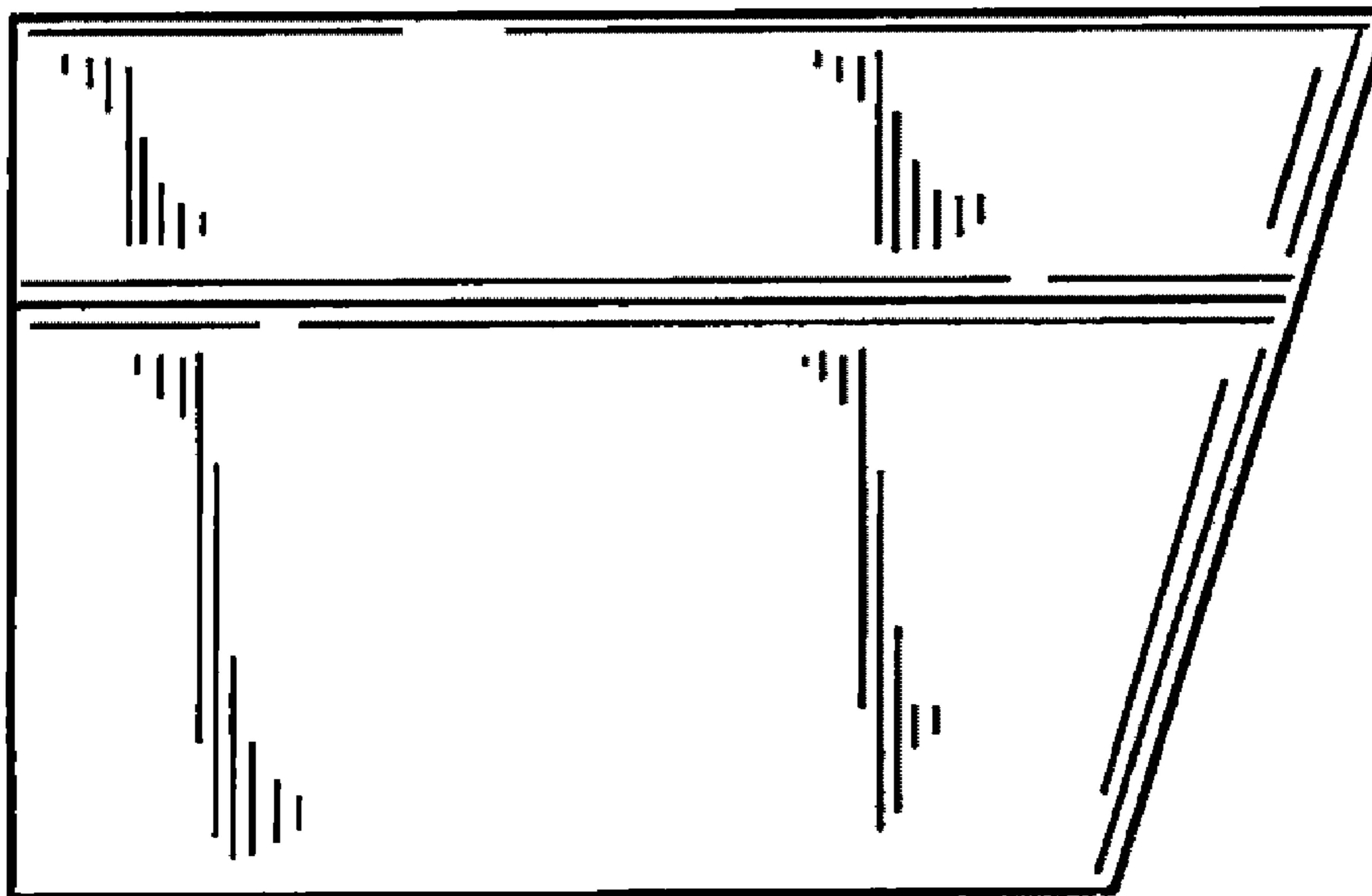

FIG. 3

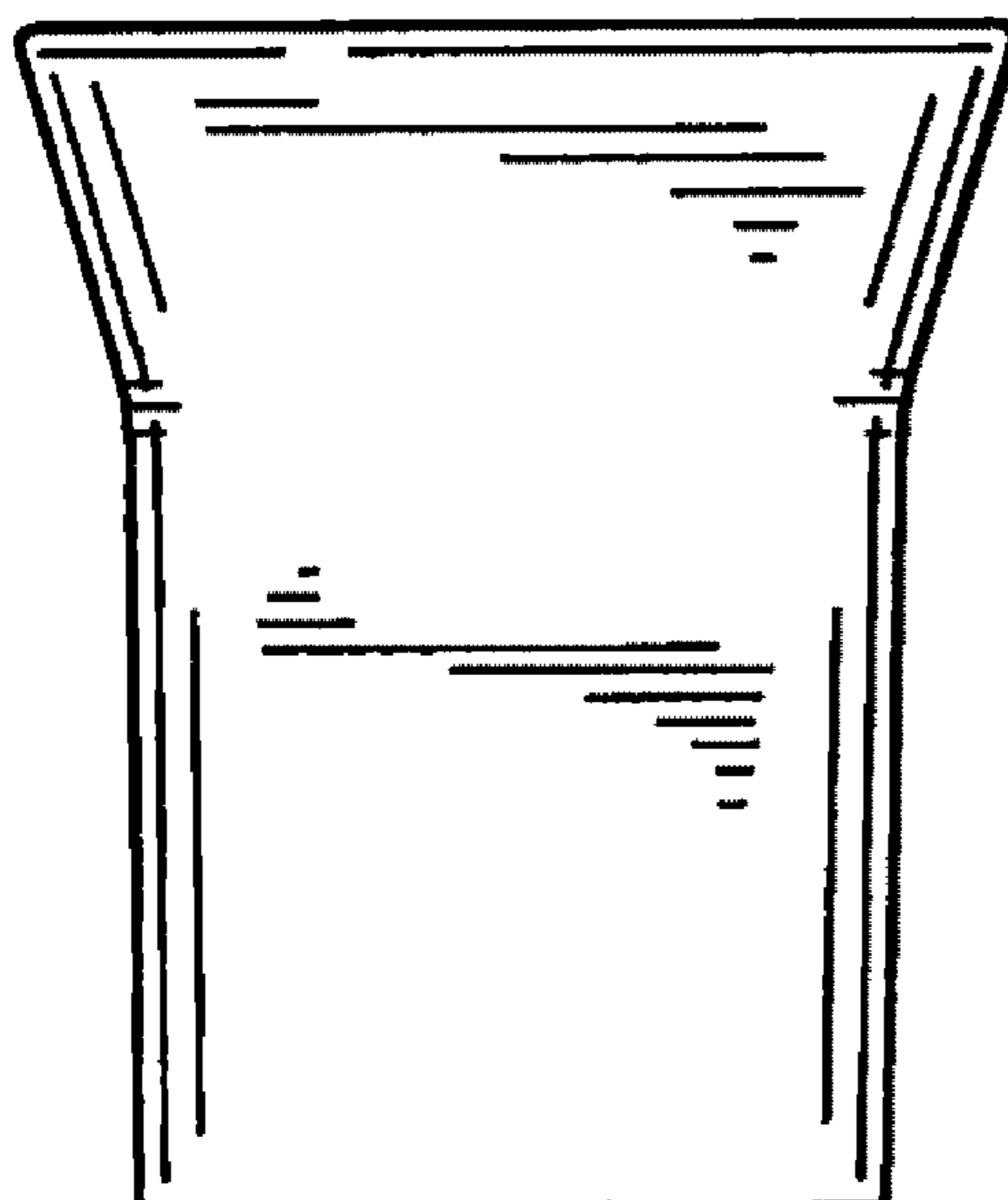

FIG. 4

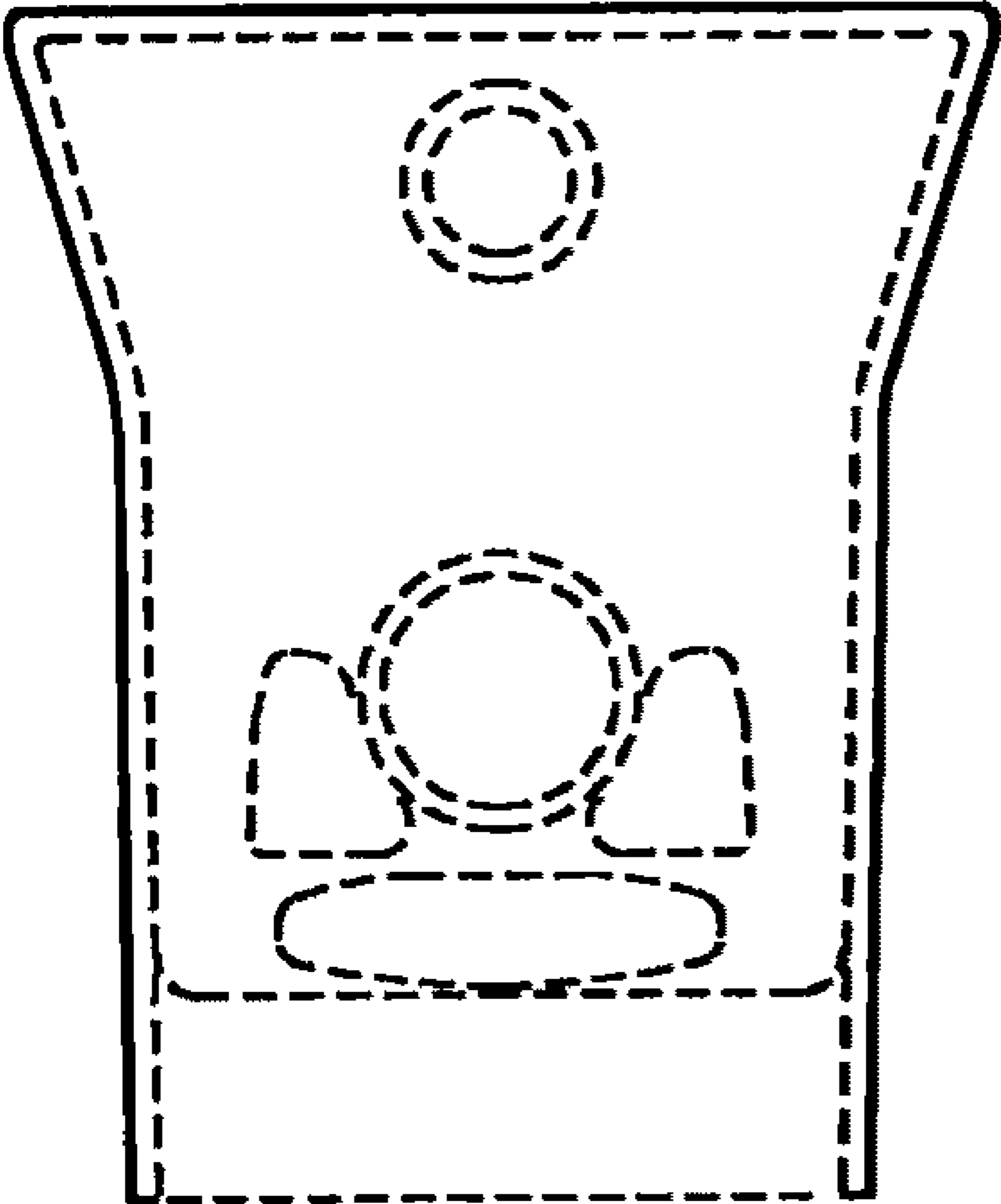

FIG. 5

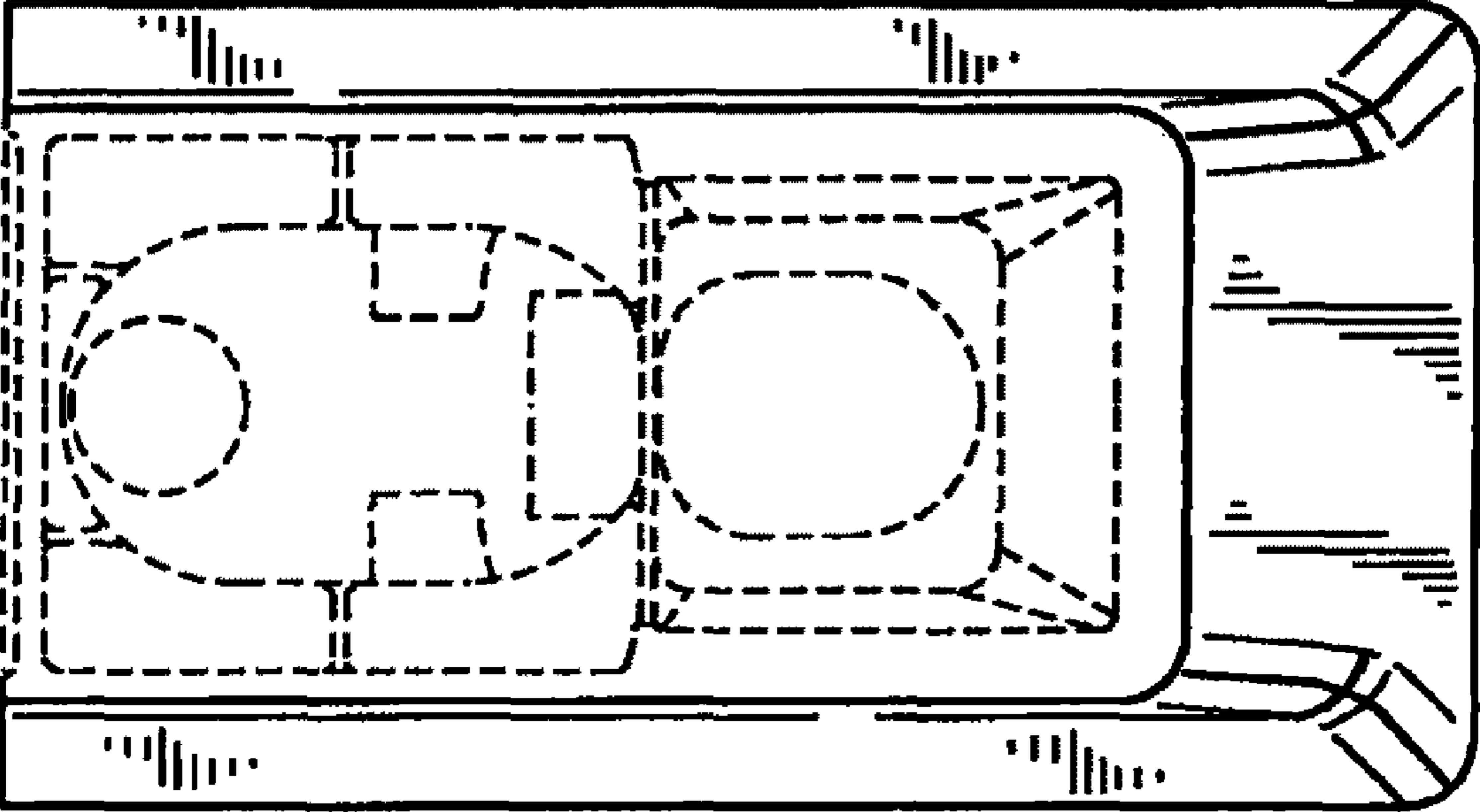

FIG. 6