



US00D622692S

(12) **United States Design Patent**  
**McWilliam et al.**

(10) **Patent No.:** **US D622,692 S**  
(45) **Date of Patent:** **\*\* Aug. 31, 2010**

(54) **COMMUNICATION DEVICE**

(75) Inventors: **Giles D. McWilliam**, Chicago, IL (US);  
**Timothy J. Sutherland**, Gurnee, IL  
(US)

(73) Assignee: **Motorola, Inc.**, Schaumburg, IL (US)

(\*\*) Term: **14 Years**

(21) Appl. No.: **29/354,192**

(22) Filed: **Jan. 20, 2010**

(51) **LOC (9) Cl.** ..... **14-03**

(52) **U.S. Cl.** ..... **D14/138 G**

(58) **Field of Classification Search** ..... D14/138 R,  
D14/138 AD, 138 AC, 138 C, 138 G, 191,  
D14/203.1–203.8, 496, 138 AA, 138 AB,  
D14/247–248, 137, 147, 218, 341–347;  
D10/65, 78, 104; D13/168; D18/7; 455/566,  
455/575.1, 575.3

See application file for complete search history.

(56) **References Cited**

**U.S. PATENT DOCUMENTS**

D489,718 S *	5/2004	Kataoka	.....	D14/346
D530,696 S *	10/2006	Lee	.....	D14/138 AA
D558,715 S *	1/2008	Lee	.....	D14/138 AD
D559,826 S *	1/2008	Lee	.....	D14/138 AD
D562,285 S *	2/2008	Lim	.....	D14/138 G
D569,837 S *	5/2008	Baik et al.	.....	D14/138 G
D572,227 S *	7/2008	Yoon et al.	.....	D14/138 G
D578,500 S *	10/2008	Lee et al.	.....	D14/138 G
D579,437 S *	10/2008	Yoon	.....	D14/138 G
D579,898 S *	11/2008	Lee et al.	.....	D14/138 G
D579,902 S *	11/2008	Kim et al.	.....	D14/138 AD
D583,345 S *	12/2008	Kim et al.	.....	D14/138 AD
D589,021 S *	3/2009	Millora	.....	D14/138 AD
D594,840 S *	6/2009	Kim et al.	.....	D14/138 G
D596,605 S *	7/2009	Son et al.	.....	D14/138 AD
D598,409 S *	8/2009	Jung et al.	.....	D14/138 G
D601,988 S *	10/2009	Bang et al.	.....	D14/138 G
D602,457 S	10/2009	Walliser et al.		
D605,158 S *	12/2009	Hung et al.	.....	D14/138 G

D607,429 S *	1/2010	Lim et al.	.....	D14/138 G
D608,327 S *	1/2010	Cigliano et al.	.....	D14/138 AD
D611,921 S *	3/2010	Bang et al.	.....	D14/138 G
D612,826 S *	3/2010	Lee et al.	.....	D14/138 G
D613,722 S *	4/2010	Kaneta	.....	D14/138 G
2007/0287512 A1 *	12/2007	Kilpi et al.	.....	455/575.1
2008/0227501 A1 *	9/2008	Joo et al.	.....	455/566
2009/0219259 A1 *	9/2009	Kwon	.....	345/173

**OTHER PUBLICATIONS**

Gigabyte GSmart S1205 Cougar, announced Mar. 2010, [online], [retrieved on Mar. 16, 2010]. Retrieved from Internet ,<URL: http://www.gsmarena.com>.\*

Haier M2000, announced 2005, [online], [retrieved on Jan. 18, 2008]. Retrieved from Internet ,<URL: http://www.gsmarena.com>.\*

(Continued)

*Primary Examiner*—Jeffrey D Asch  
*Assistant Examiner*—Bridget L Eland

(57) **CLAIM**

The ornamental design for a communication device, as shown and described.

**DESCRIPTION**

FIG. 1 is a front perspective view of an ornamental design for a communication device;

FIG. 2 is a rear perspective view thereof;

FIG. 3 is a front view thereof;

FIG. 4 is a rear view thereof;

FIG. 5 is first side view thereof;

FIG. 6 is a second side view thereof;

FIG. 7 is a top view thereof; and,

FIG. 8 is a bottom view thereof.

The broken lines that are immediately adjacent the shaded areas, and define unshaded regions, represent the bounds of the claimed design, while all other broken lines are directed to environment and are for illustrative purposes only; the broken lines form no part of the claimed design.

**1 Claim, 5 Drawing Sheets**

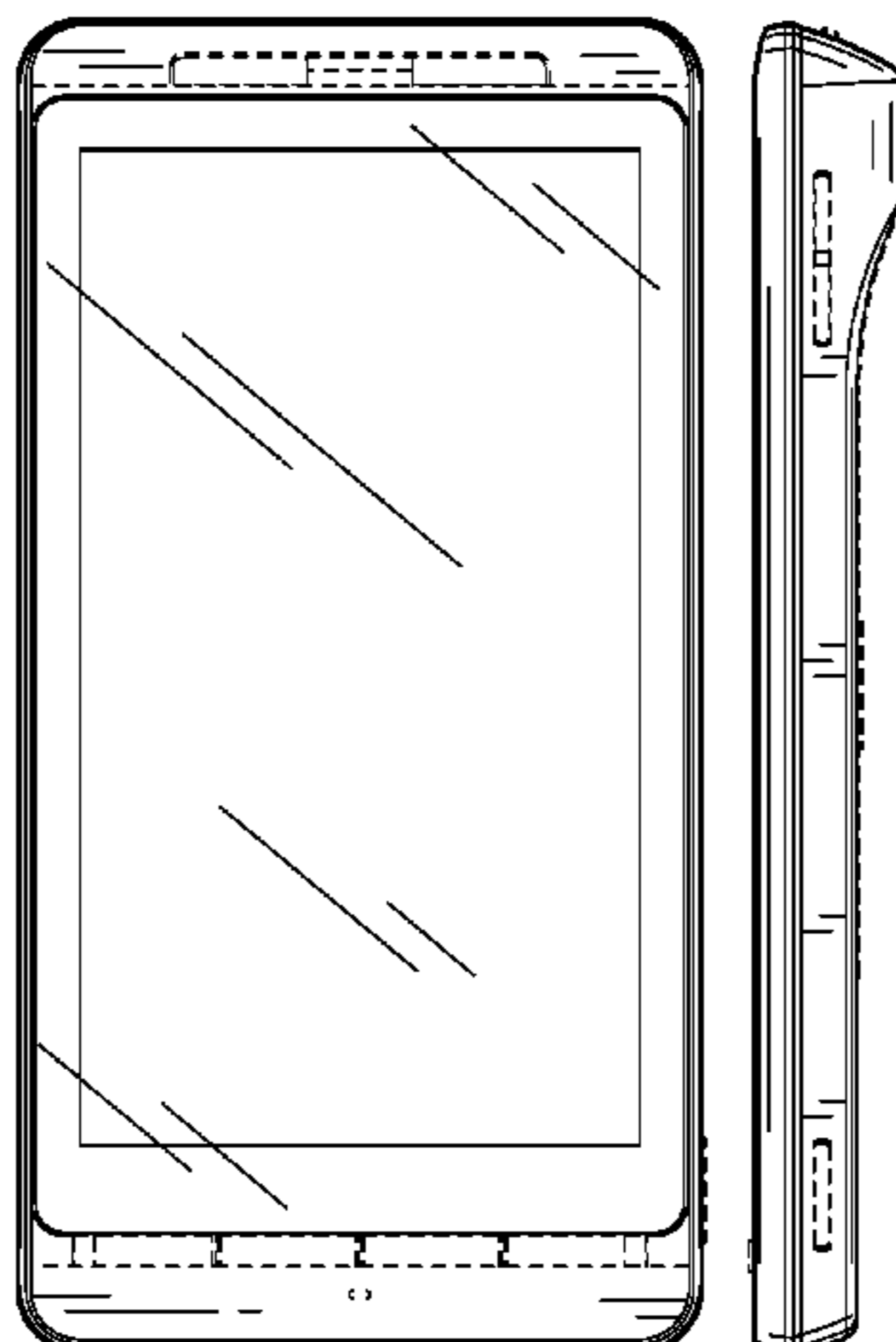

OTHER PUBLICATIONS

HTC Touch Diamond2, announced Feb. 2009, [online], [retrieved on Feb. 20, 2009]. Retrieved from Internet ,<URL: <http://www.gsmarena.com>>.\*

LG GD880 Mini, announced Feb. 2010, [online], [retrieved on Feb. 17, 2010]. Retrieved from Internet ,<URL: <http://www.gsmarena.com>>.\*

Motorola ROKR ZN50, announced Jul. 2009, [online], [retrieved on Jul. 13, 2009]. Retrieved from Internet ,<URL: <http://www.gsmarena.com>>.\*

Motorola Milestone, announced Nov. 2009, [online], [retrieved on Nov. 24, 2009]. Retrieved from Internet ,<URL: <http://www.gsmarena.com>>.\*

Philips C700, announced Sep. 2009, [online], [retrieved on Oct. 1, 2009]. Retrieved from Internet ,<URL: <http://www.gsmarena.com>>.\*

LG KF700, announced Feb. 2008, [online], [retrieved on Mar. 21, 2008 & May 14, 2008]. Retrieved from Internet ,<URL: <http://www.gsmarena.com>>.\*

U.S. Appl. No. 29/338,063, filed Jun. 3, 2009, in the name of Eric J. Price, entitled "Communication Device".

\* cited by examiner

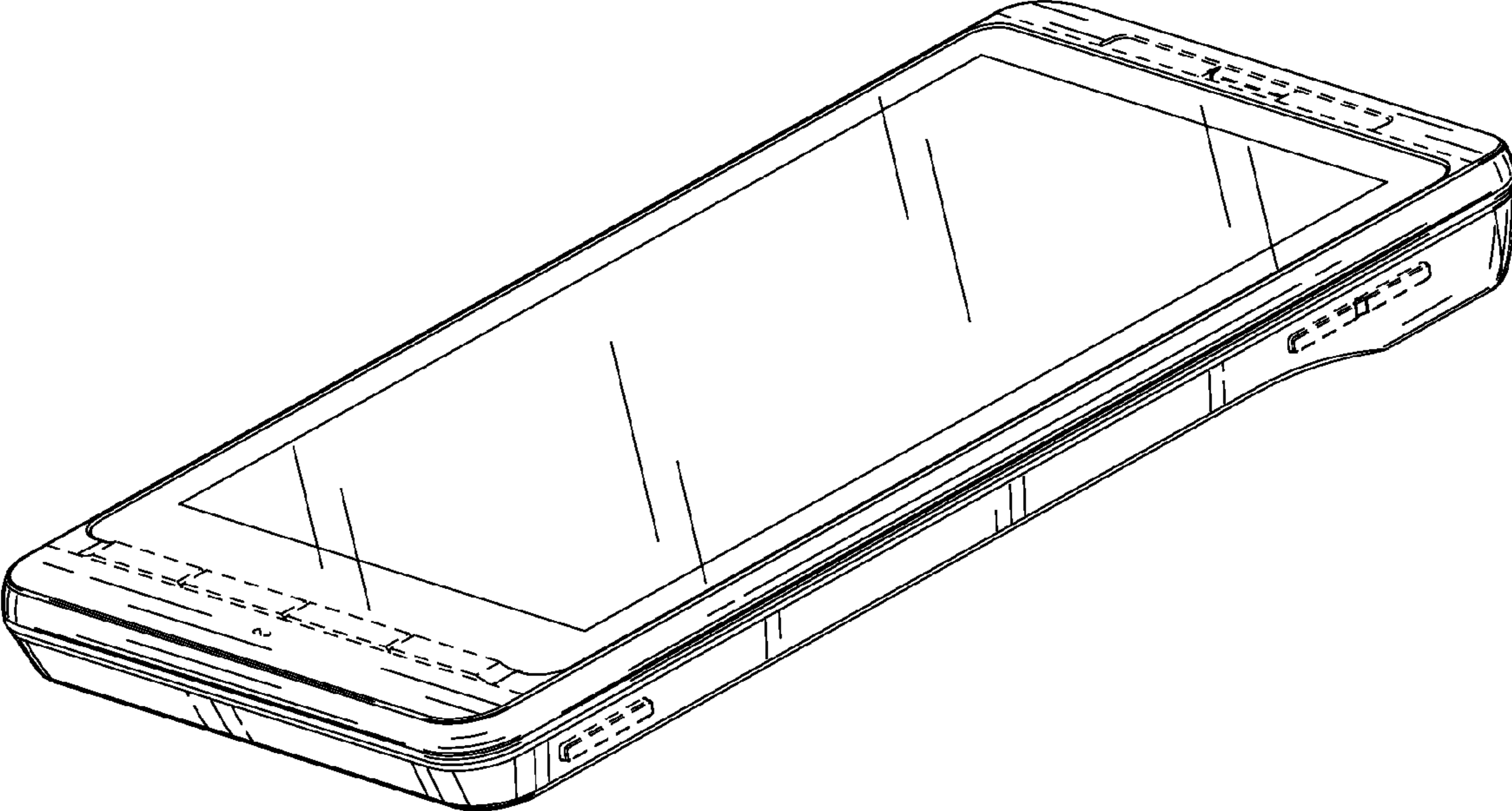

FIG. 1

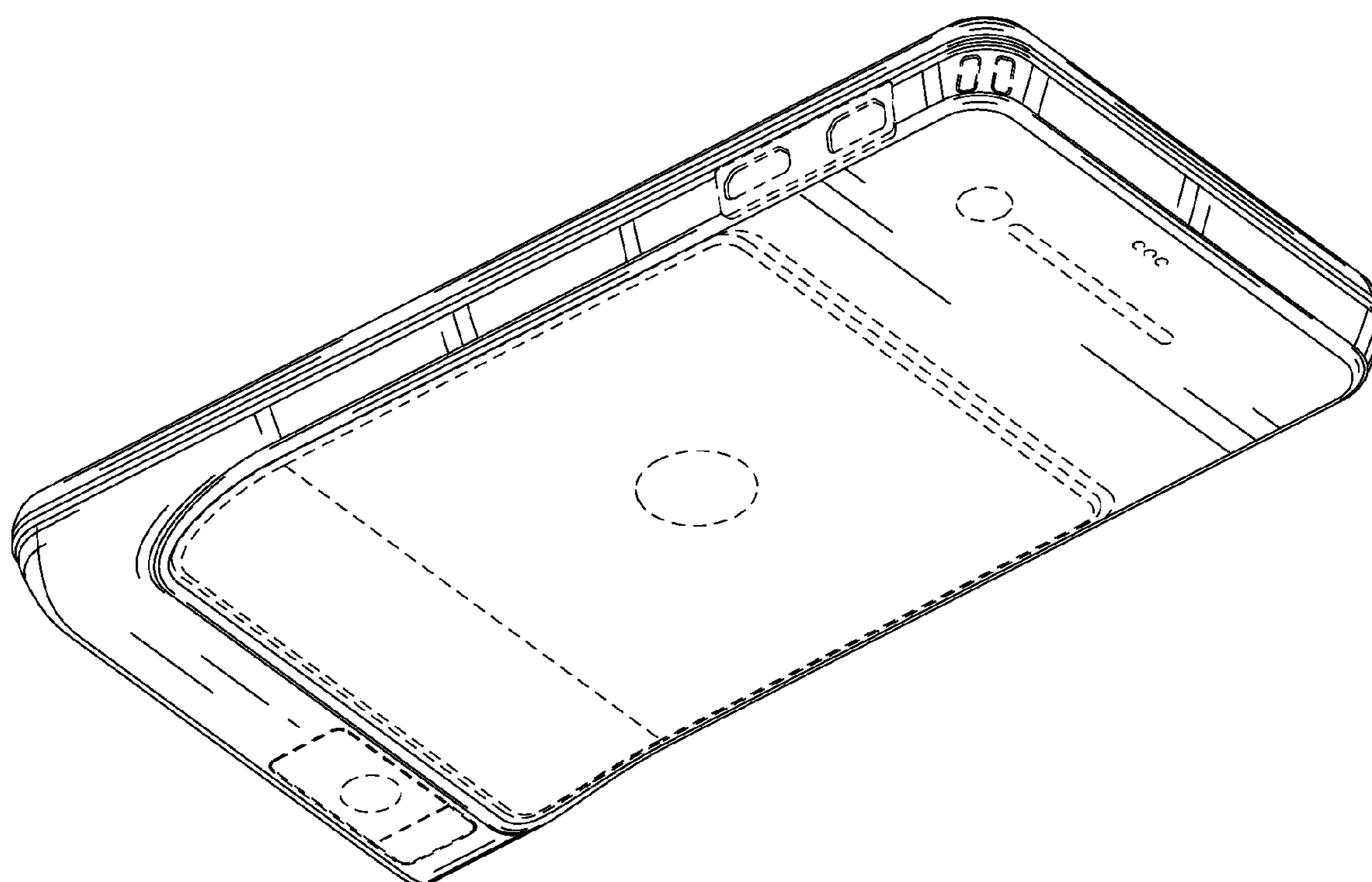

FIG. 2

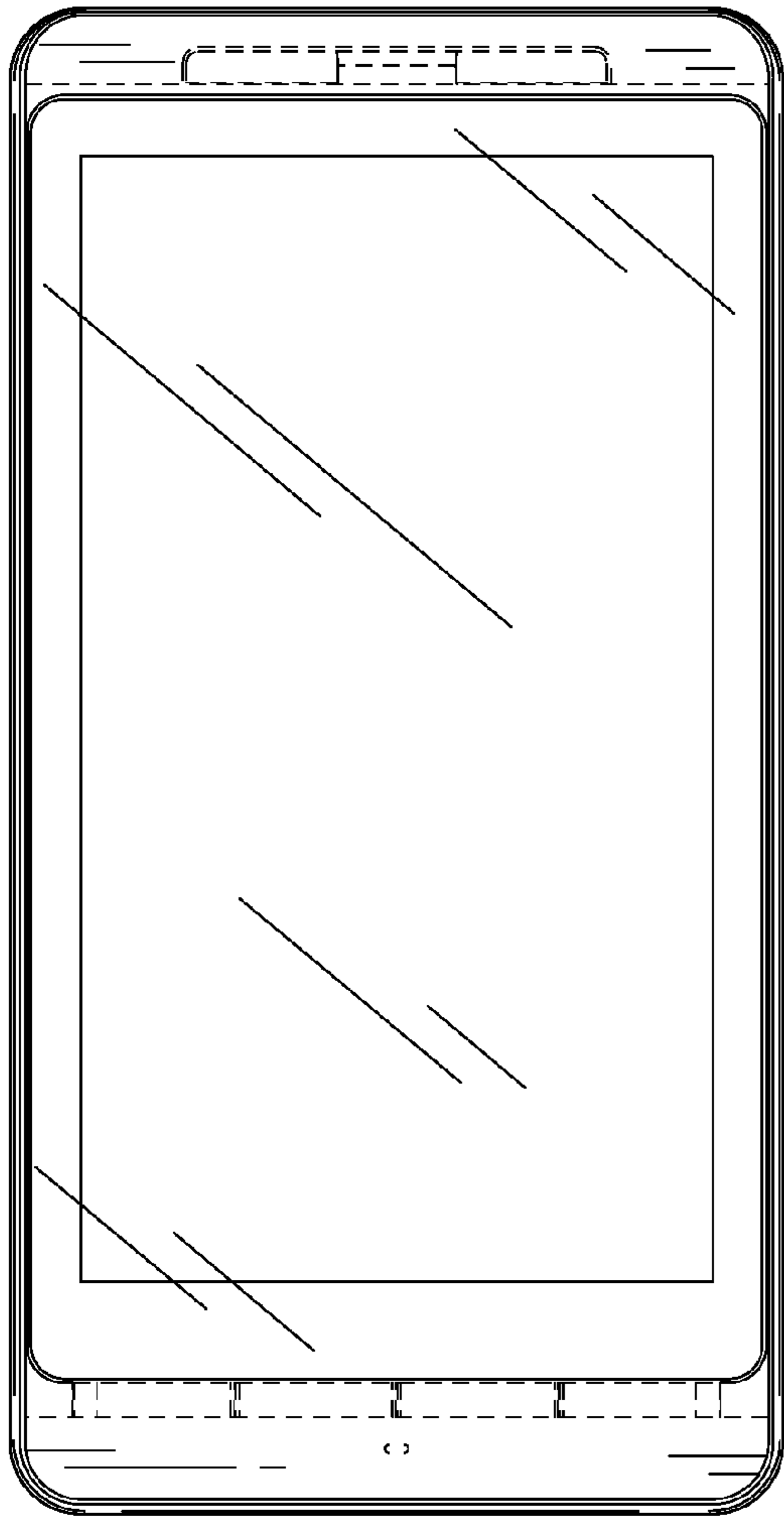

FIG. 3

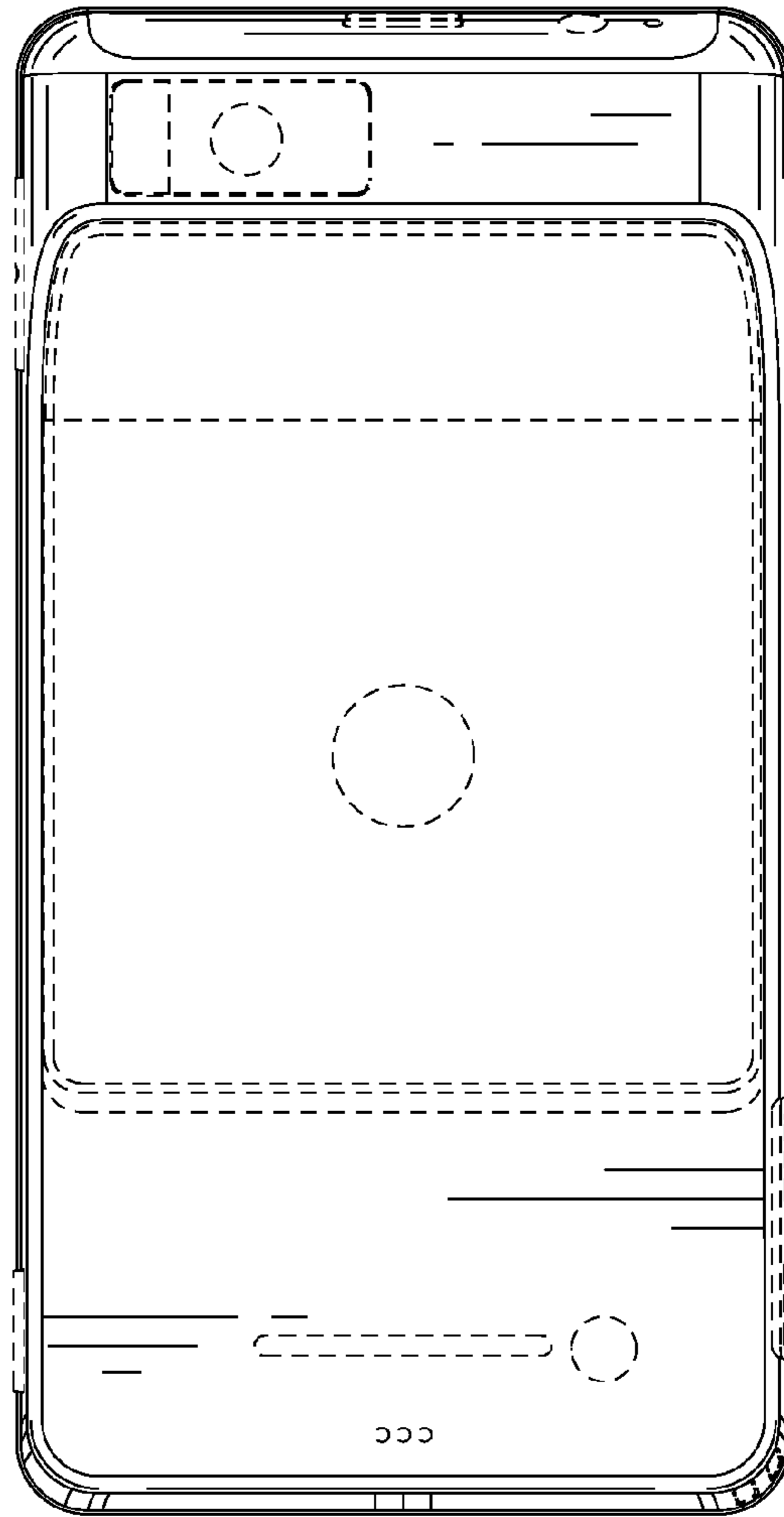

FIG. 4

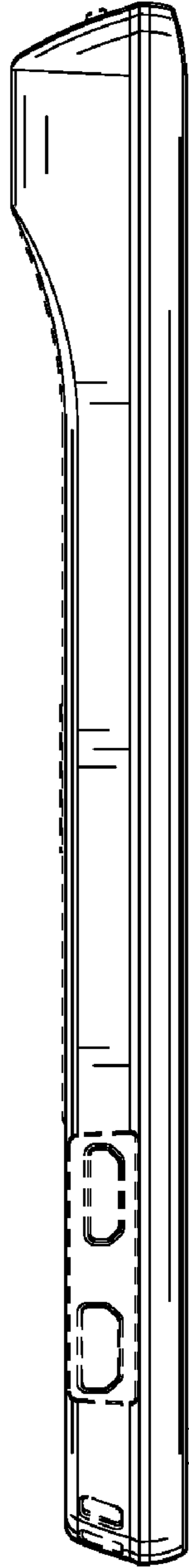

FIG. 5

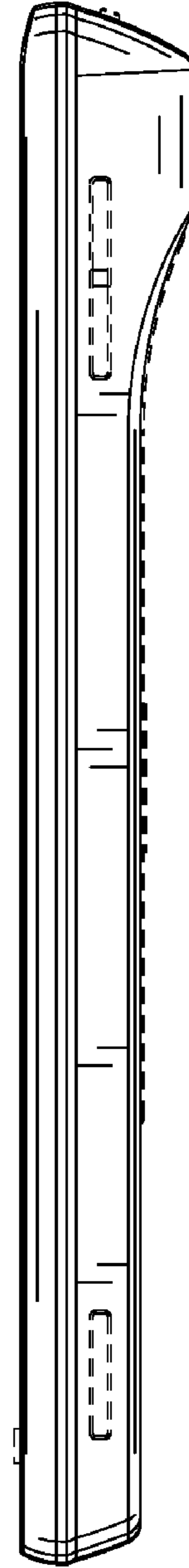

FIG. 6

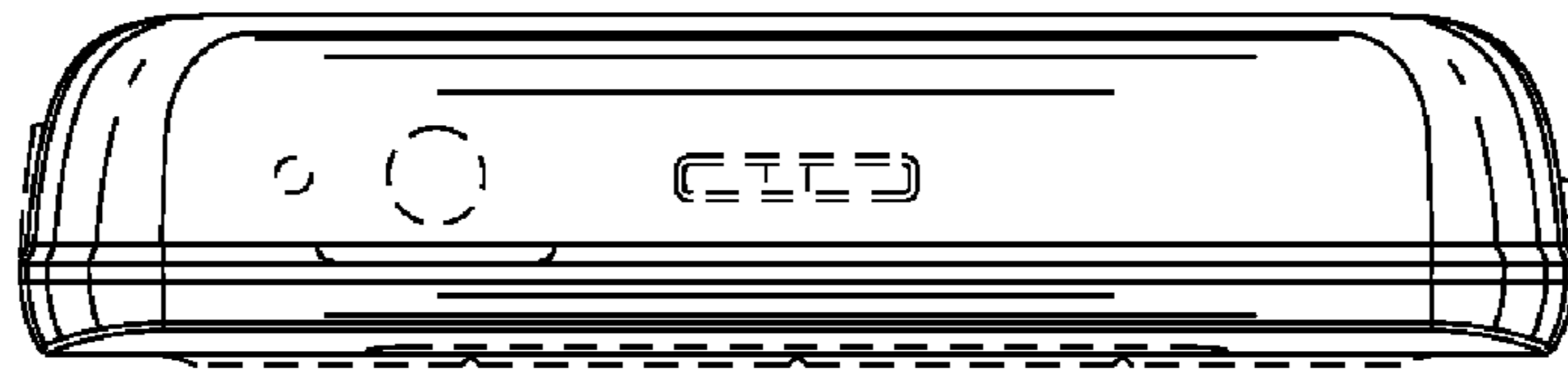

FIG. 7



FIG. 8