



US00D622690S

(12) **United States Design Patent**
Kwon et al.

(10) **Patent No.:** **US D622,690 S**
(45) **Date of Patent:** **** Aug. 31, 2010**

(54) **MOBILE PHONE**

(75) Inventors: **Kyung-Jun Kwon**, Hanam-si (KR);
Sang-Min Hyun, Seoul (KR); **Nam-Mi Kim**, Seoul (KR)

(73) Assignee: **Samsung Electronics Co., Ltd.**,
Suwon-si (KR)

(**) Term: **14 Years**

(21) Appl. No.: **29/351,019**

(22) Filed: **Nov. 27, 2009**

(30) **Foreign Application Priority Data**

Oct. 22, 2009 (KR) 30-2009-0046470

(51) **LOC (9) Cl.** **14-03**

(52) **U.S. Cl.** **D14/138 AD**

(58) **Field of Classification Search** D14/138 R,
D14/138 AD, 138 AC, 138 C, 138 G, 191,
D14/203.1–203.8, 496, 138 AA, 138 AB,
D14/247–248, 137, 147, 218, 341–347; D10/65,
D10/78, 104; D13/168; D18/7; 455/566,
455/575.1, 575.3

See application file for complete search history.

(56) **References Cited**

U.S. PATENT DOCUMENTS

D526,302 S * 8/2006 Kim D14/138 AD
D526,986 S * 8/2006 Kim D14/138 AD
D543,966 S * 6/2007 Peng et al. D14/138 AD
D545,289 S * 6/2007 Wang D14/138 AD
D545,290 S * 6/2007 Yau D14/138 AD
D550,640 S * 9/2007 Dai D14/138 AD
D572,695 S * 7/2008 Tu D14/138 AD
D576,590 S * 9/2008 Benoit D14/138 AD
D576,595 S * 9/2008 Han et al. D14/138 AD
D580,391 S * 11/2008 Kim et al. D14/138 AD

D585,865 S * 2/2009 Lim et al. D14/138 AB
D588,085 S * 3/2009 Lin D14/138 AD
D590,803 S * 4/2009 Rihu D14/138 AD
D591,709 S * 5/2009 Rihu D14/138 AD
D597,515 S * 8/2009 Kim D14/138 AD

(Continued)

OTHER PUBLICATIONS

BenQ-Siemens AL26, announced Aug. 2006, [online], [retrieved on Feb. 16, 2007]. Retrieved from Internet ,<URL: <http://www.gsmarena.com>>.*

(Continued)

Primary Examiner—Jeffrey D Asch
Assistant Examiner—Bridget L Eland
(74) *Attorney, Agent, or Firm*—NSIP Law

(57) **CLAIM**

The ornamental design for a mobile phone, as shown and described.

DESCRIPTION

FIG. 1 is a perspective view of a mobile phone;
FIG. 2 is a front view of the mobile phone of FIG. 1;
FIG. 3 is a rear view of the mobile phone of FIG. 1;
FIG. 4 is a left-side view of the mobile phone of FIG. 1;
FIG. 5 is a right-side view of the mobile phone of FIG. 1;
FIG. 6 is a top plan view of the mobile phone of FIG. 1;
FIG. 7 is a bottom plan view of the mobile phone of FIG. 1;
and,
FIG. 8 is a front open view of the mobile phone of FIG. 1.

1 Claim, 6 Drawing Sheets

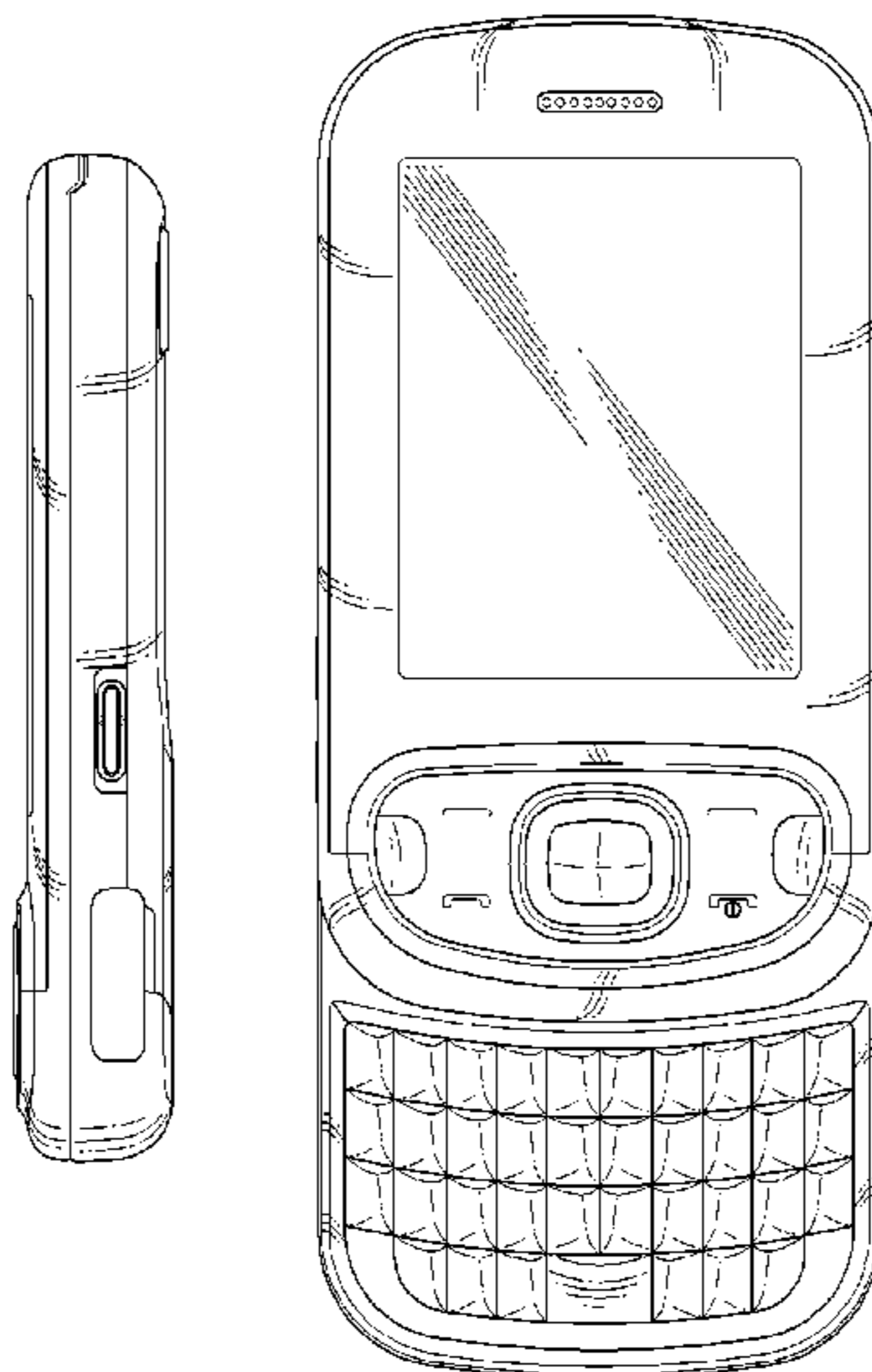

U.S. PATENT DOCUMENTS

D602,461 S * 10/2009 Kim et al. D14/138 AD
7,627,355 B2 * 12/2009 Amano et al. 455/575.4
D607,428 S * 1/2010 Kim et al. D14/138 AD
D608,330 S * 1/2010 Jeoung et al. D14/138 AD
D608,334 S * 1/2010 van den Brand D14/138 AD
D611,020 S * 3/2010 Garnham D14/138 AD
D611,026 S * 3/2010 Kim et al. D14/138 AD
2005/0070344 A1 * 3/2005 Im et al. 455/575.1
2005/0124381 A1 * 6/2005 Kim et al. 455/556.1
2005/0190291 A1 * 9/2005 Kota et al. 348/376
2007/0021160 A1 * 1/2007 Li 455/575.4

OTHER PUBLICATIONS

Bird D736, announced 2007, [online], [retrieved on Aug. 6, 2007].
Retrieved from Internet ,<URL: <http://www.gsmarena.com>>.*

HP iPAQ rw6818, announced 2nd quarter 2006, [online], [retrieved on Feb. 20, 2007]. Retrieved from Internet ,<URL: <http://www.gsmarena.com>>.*

HTC P3600, announced Sep. 2006, [online], [retrieved on Feb. 20, 2007]. Retrieved from Internet ,<URL: <http://www.gsmarena.com>>.*

i-mate JAMA 101, announced Oct. 2007, [online], [retrieved on Dec. 13, 2007]. Retrieved from Internet ,<URL: <http://www.gsmarena.com>>.*

LG GU280 Popcorn, announced Oct. 2009, [online], [retrieved on Nov. 20, 2009]. Retrieved from Internet ,<URL: <http://www.gsmarena.com>>.*

Siemens AL21, announced Nov. 2005, [online], [retrieved on Feb. 20, 2007]. Retrieved from Internet ,<URL: <http://www.gsmarena.com>>.*

Samsung A687 Strive, announced Mar. 2010, [online], [retrieved on Mar. 16, 2010]. Retrieved from Internet ,<URL: <http://www.gsmarena.com>>.*

* cited by examiner

FIG. 1

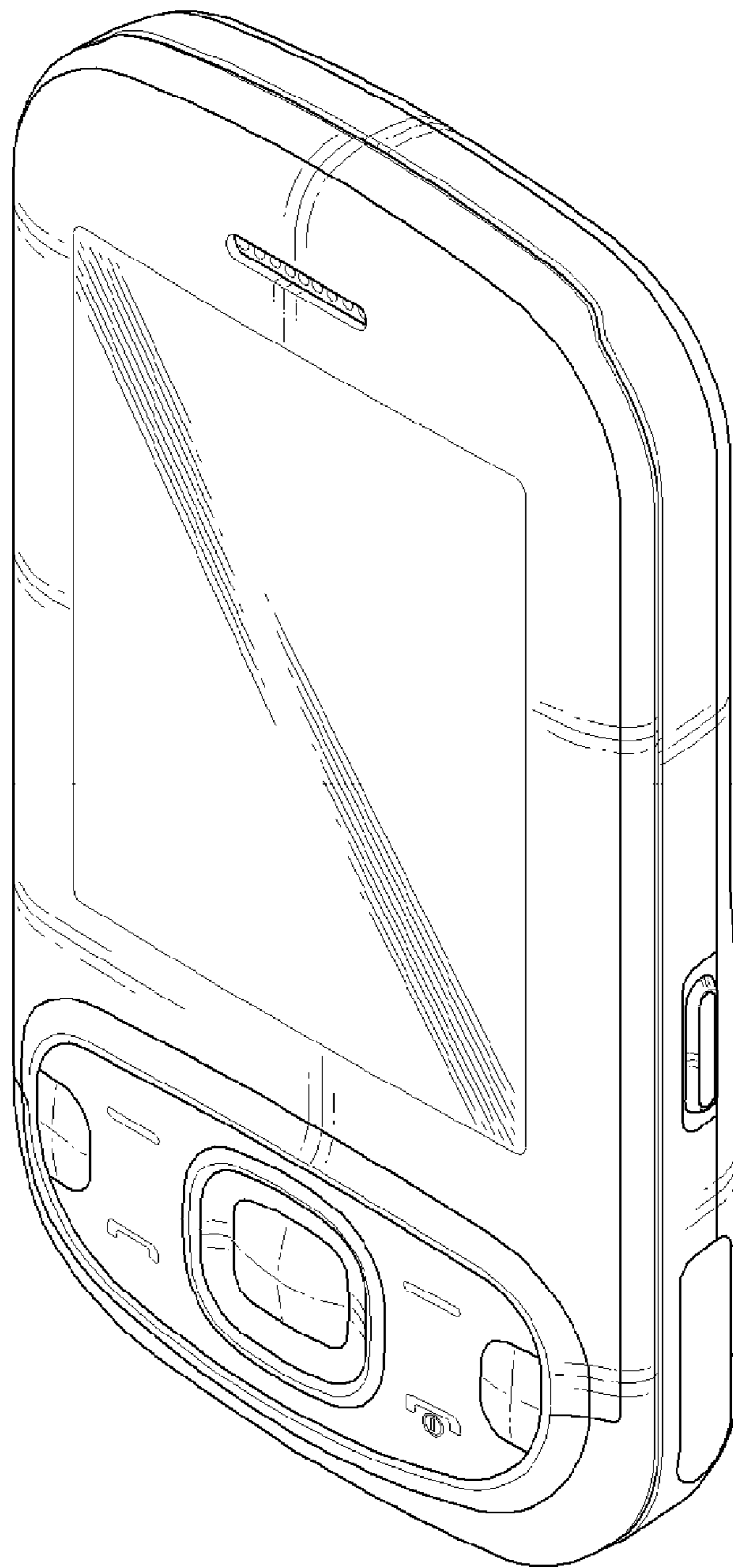

FIG. 2

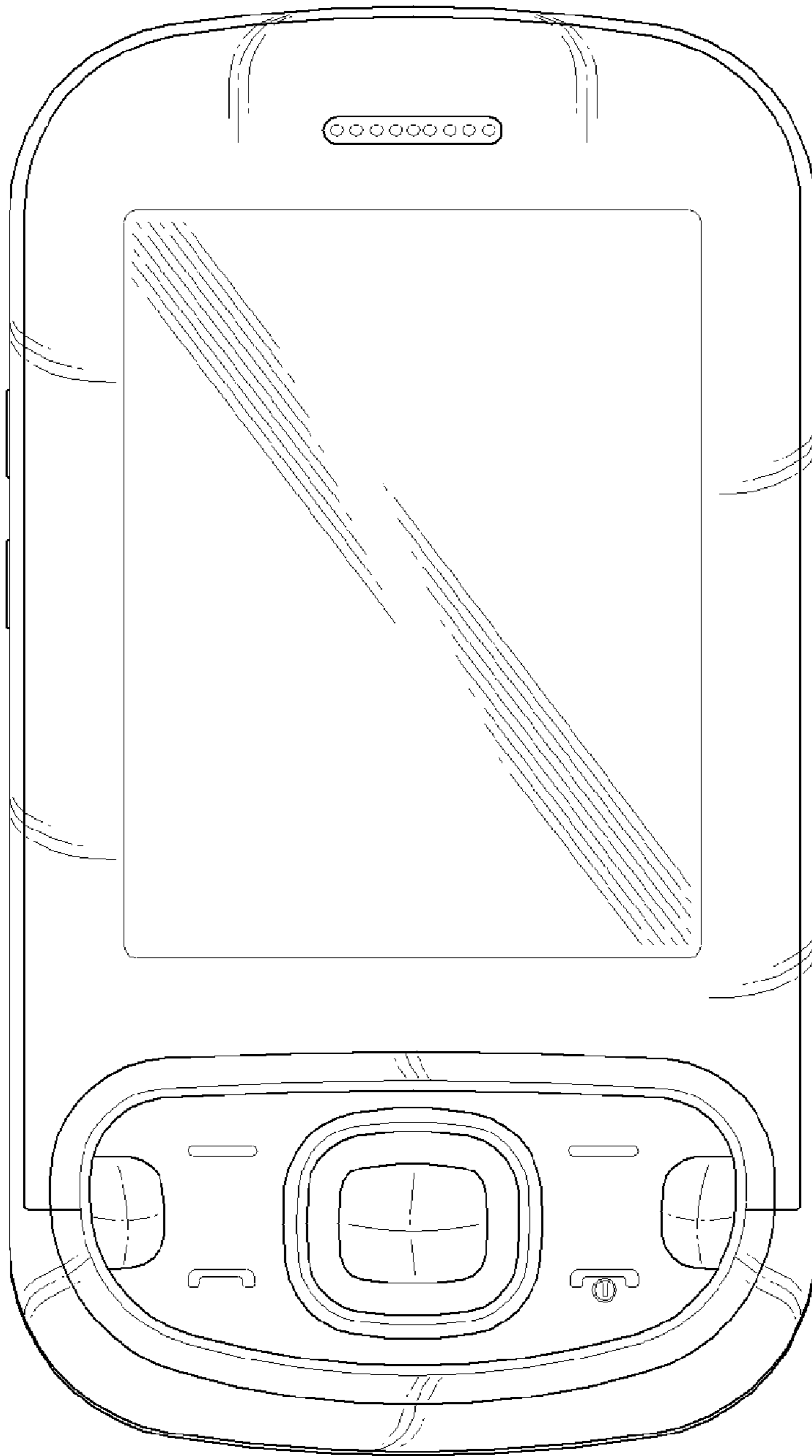

FIG. 3

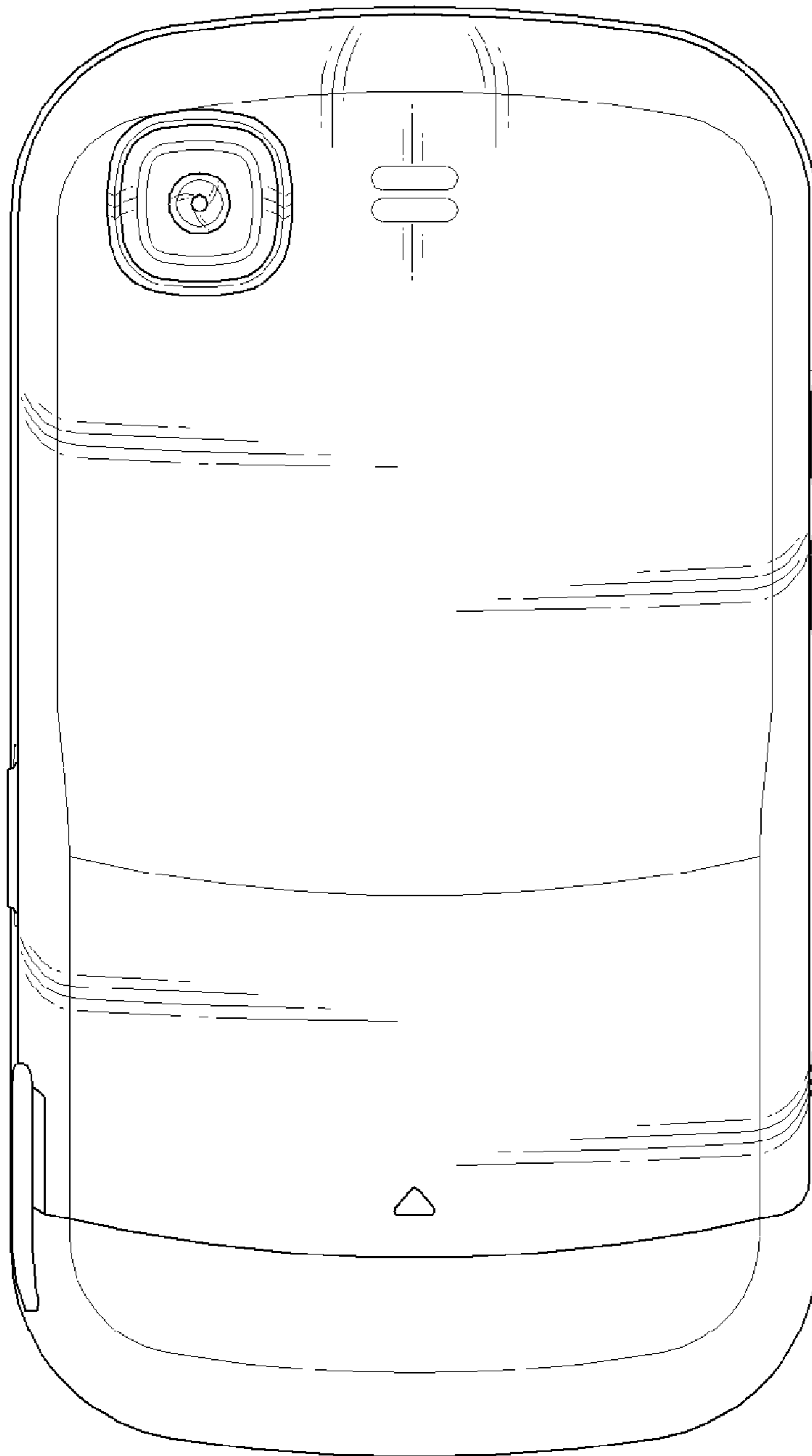

FIG. 4

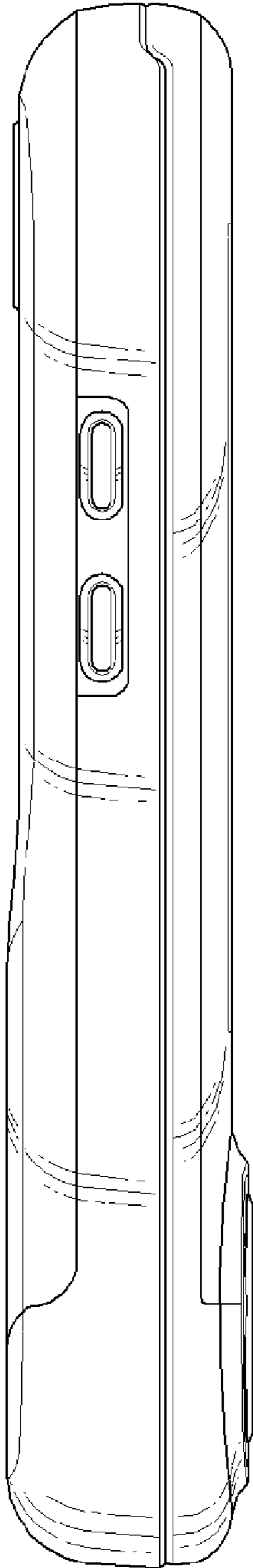

FIG. 5

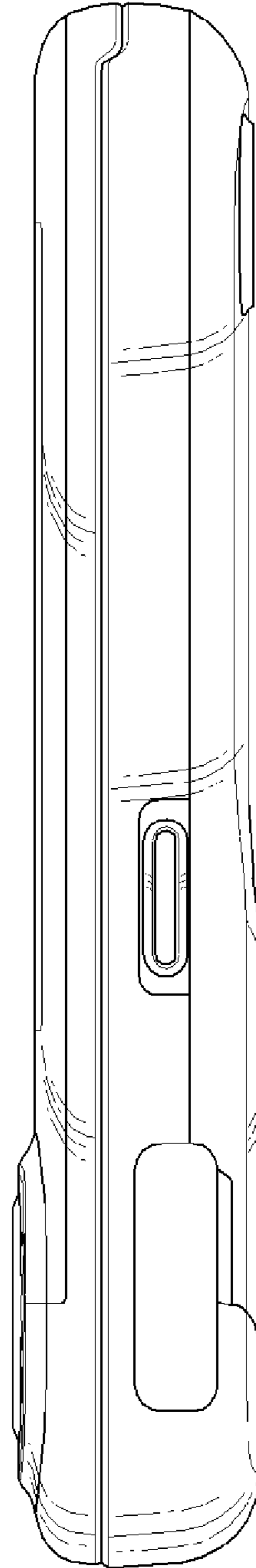

FIG. 6

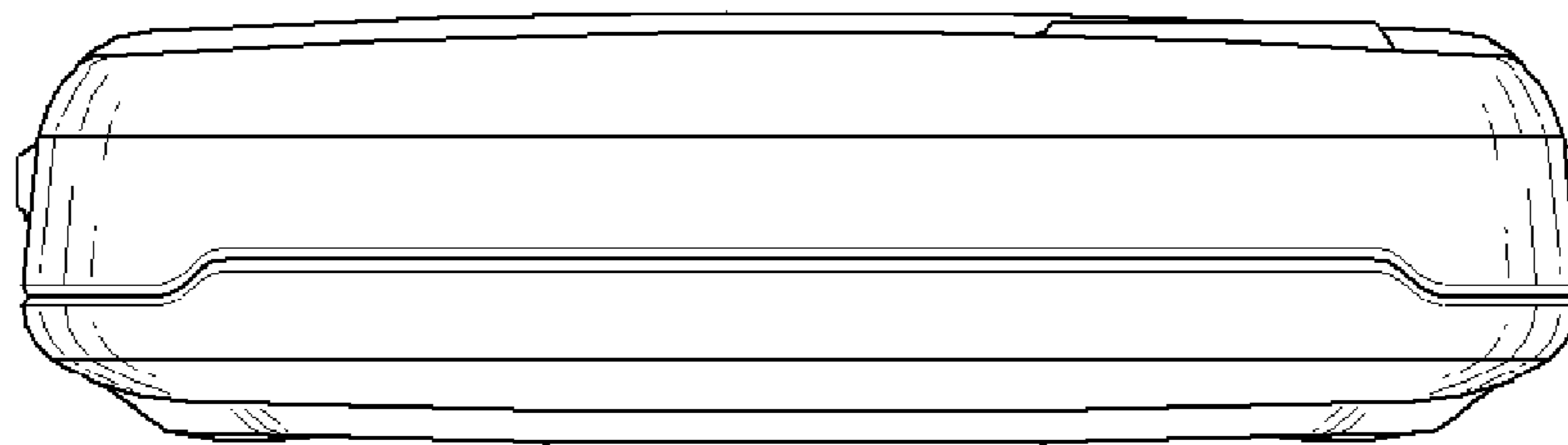

FIG. 7

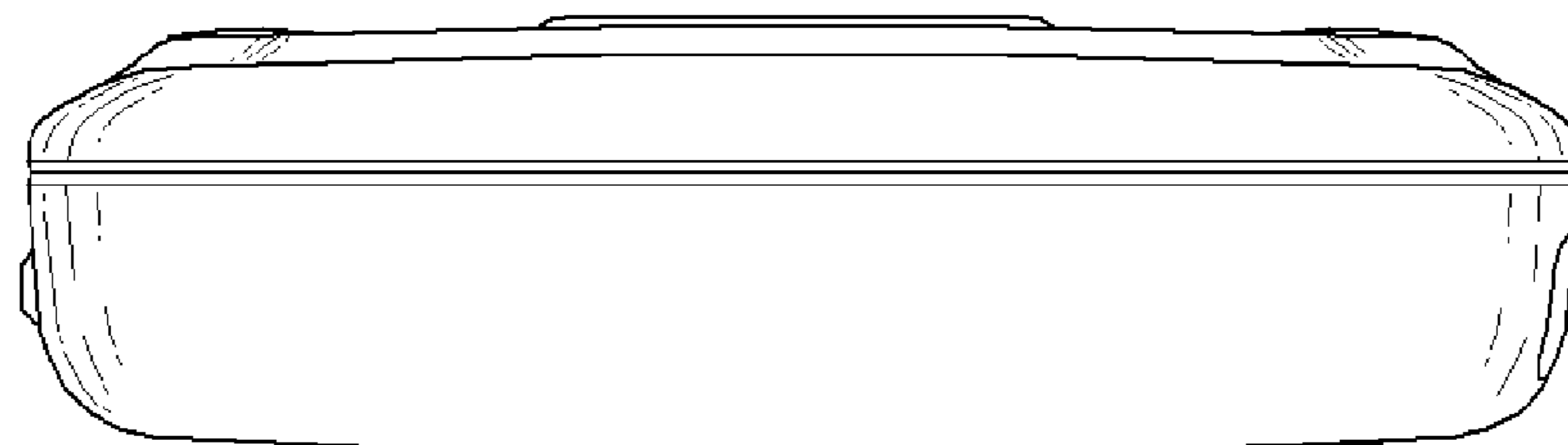

FIG. 8

