



US00D622586S

(12) **United States Design Patent**
Turnbull

(10) **Patent No.:** **US D622,586 S**

(45) **Date of Patent:** **** Aug. 31, 2010**

(54) **HIGH PROFILE CORNER SHIELD**

(75) Inventor: **Jeff Turnbull**, Kannapolis, NC (US)

(73) Assignee: **Sealy Technology LLC**, Trinity, NC (US)

(**) Term: **14 Years**

(21) Appl. No.: **29/345,884**

(22) Filed: **Oct. 23, 2009**

(51) **LOC (9) Cl.** **08-09**

(52) **U.S. Cl.** **D8/403**

(58) **Field of Classification Search** D6/606;
D8/400-499; 5/739, 717, 663, 400, 261,
5/254; D29/120.1, 121.1, 121.2

See application file for complete search history.

(56) **References Cited**

U.S. PATENT DOCUMENTS

3,735,419	A *	5/1973	Byrd	2/22
D232,496	S *	8/1974	Rawlings	D29/120.1
D280,250	S *	8/1985	Vacanti	D29/120.1
5,265,291	A	11/1993	Callaway		
6,263,533	B1	7/2001	Dimitry et al.		
6,286,161	B1	9/2001	McCall		
6,493,887	B1	12/2002	DeFranks et al.		
6,687,929	B2	2/2004	DeFranks et al.		
7,216,380	B2	5/2007	Vaskuthy		
D575,144	S *	8/2008	Heisten et al.	D8/403
D575,145	S *	8/2008	Heisten et al.	D8/403

D594,160	S *	6/2009	Worden	D29/121.1
2003/0110562	A1 *	6/2003	DeFranks et al.	5/254
2007/0011818	A1 *	1/2007	Vaskuthy	5/717

* cited by examiner

Primary Examiner—Cathron C Brooks

Assistant Examiner—Barbara Fox

(74) *Attorney, Agent, or Firm*—James C. Scott; Roetzel & Andress

(57) **CLAIM**

The ornamental design for the high profile corner shield, as shown and described.

DESCRIPTION

FIG. 1 is a front perspective view of the high profile corner shield of the present invention.

FIG. 2 is a rear perspective view of the high profile corner shield of FIG. 1.

FIG. 3 is a top view of the high profile corner shield of FIG. 1.

FIG. 4 is a bottom view of the high profile corner shield of FIG. 1.

FIG. 5 is a left elevation view of the high profile corner shield of FIG. 1.

FIG. 6 is a front elevation view of the high profile corner shield of FIG. 1; and,

FIG. 7 is a rear elevation view of the high profile corner shield of FIG. 1.

1 Claim, 2 Drawing Sheets

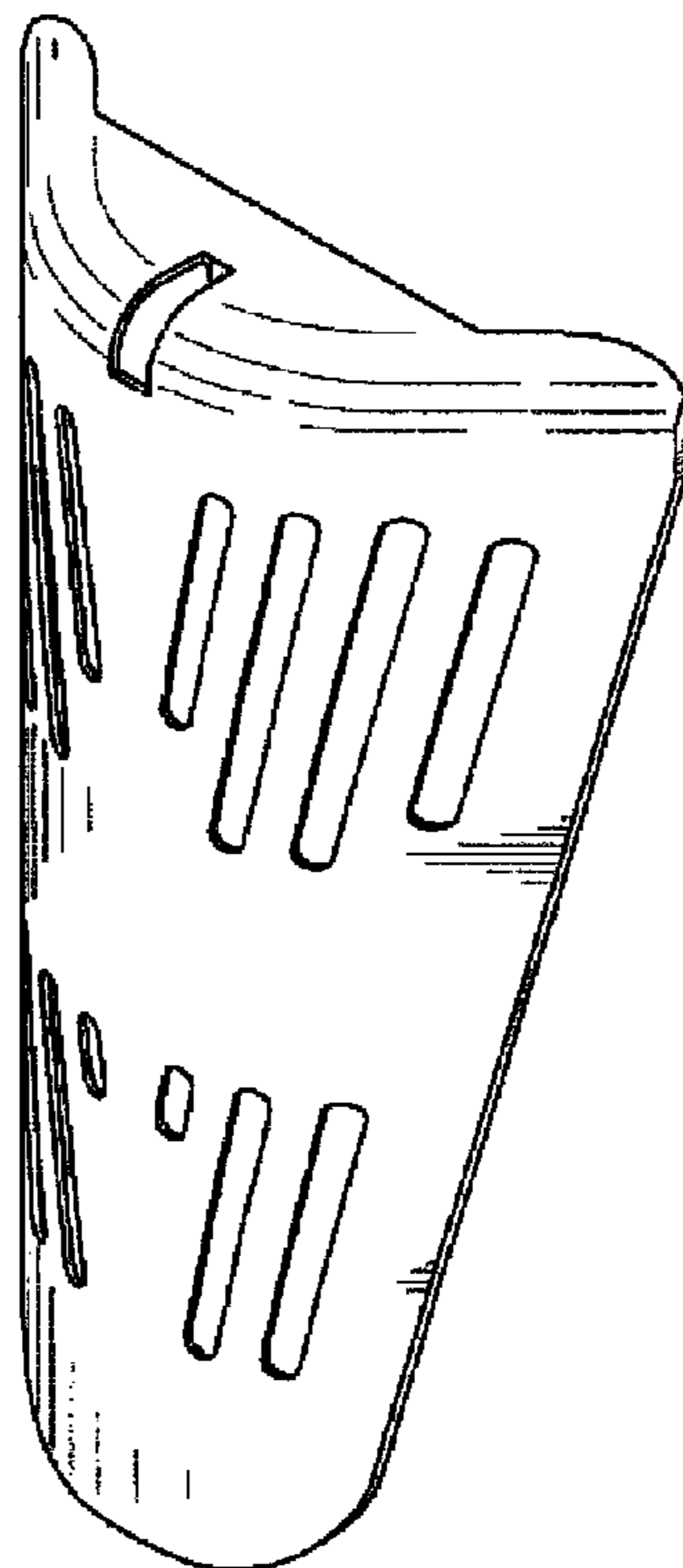

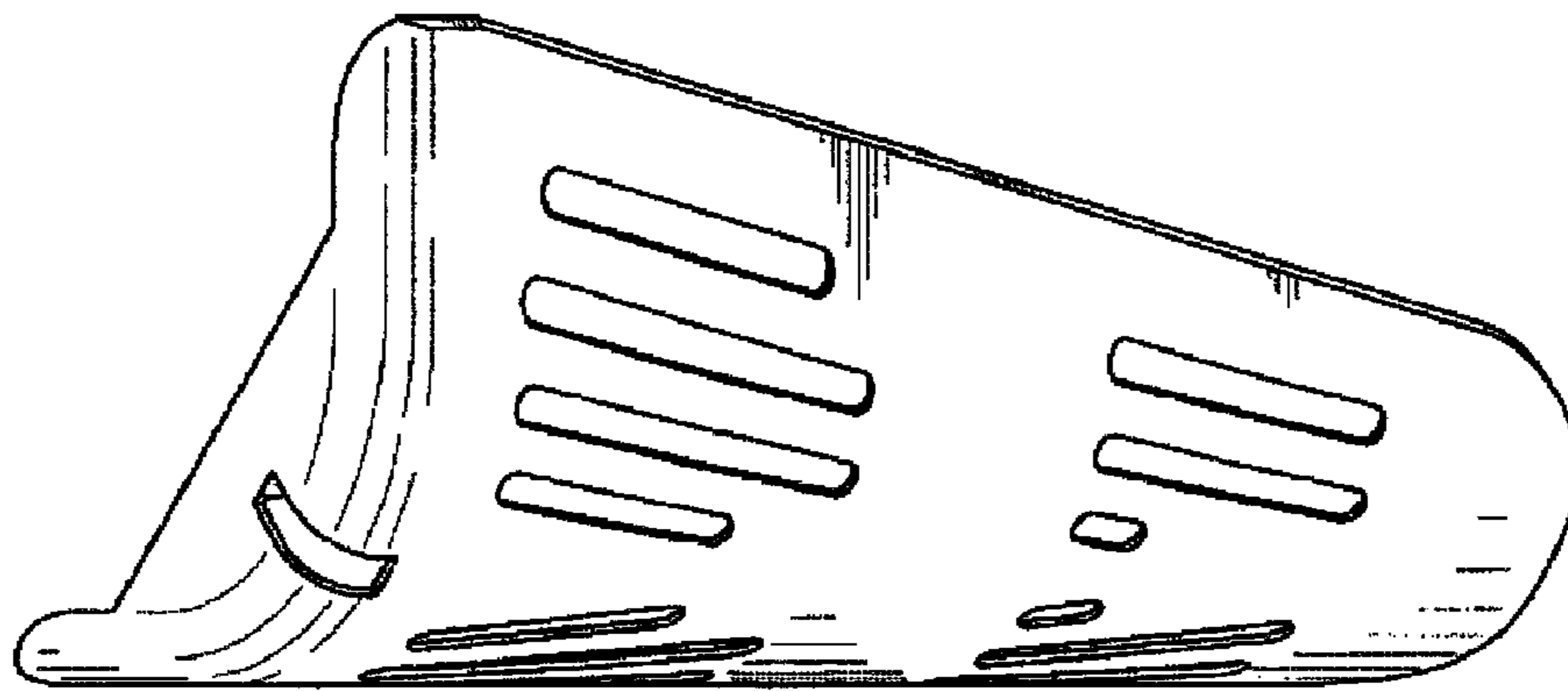

Fig. 1

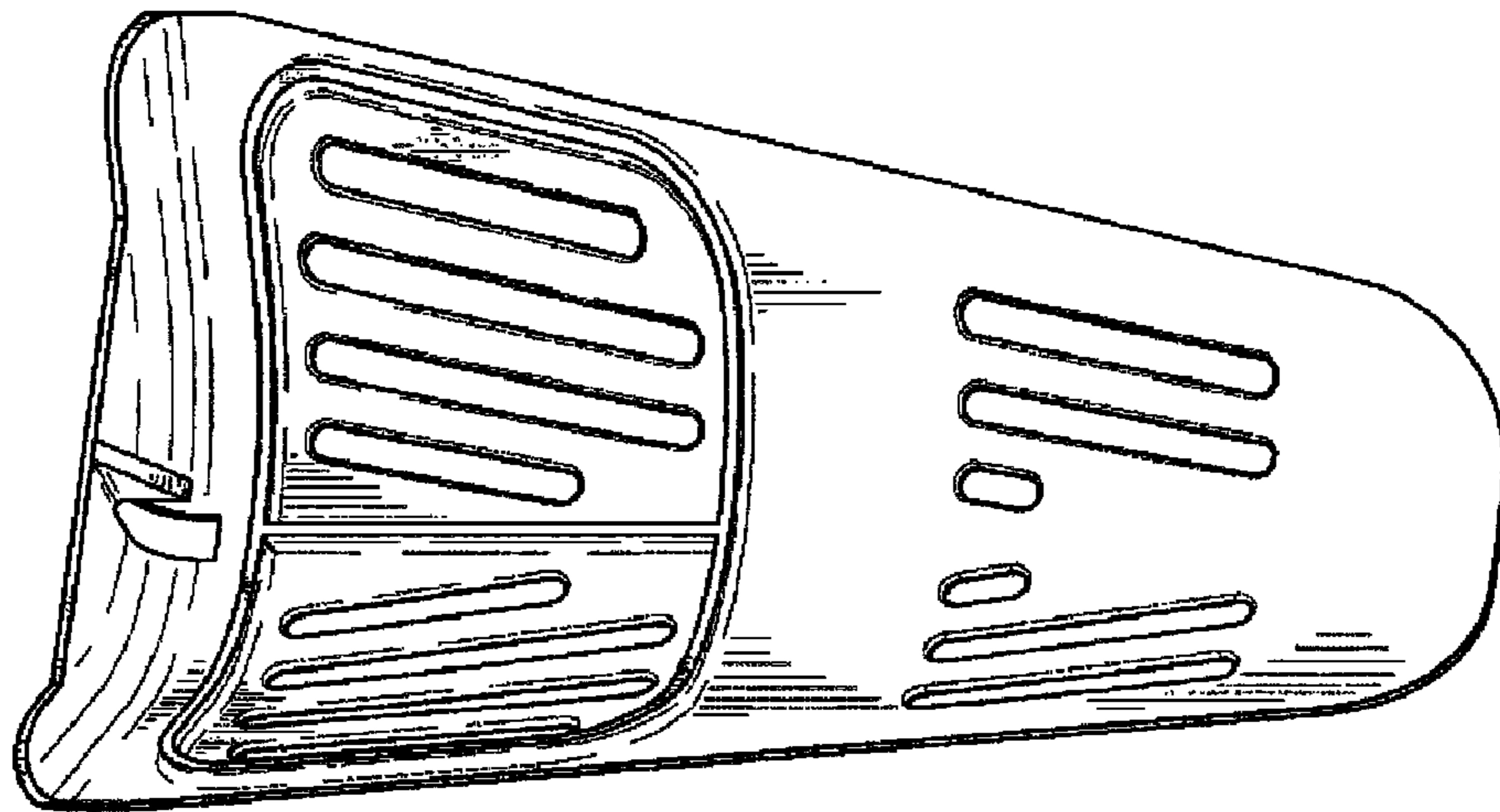

Fig. 2

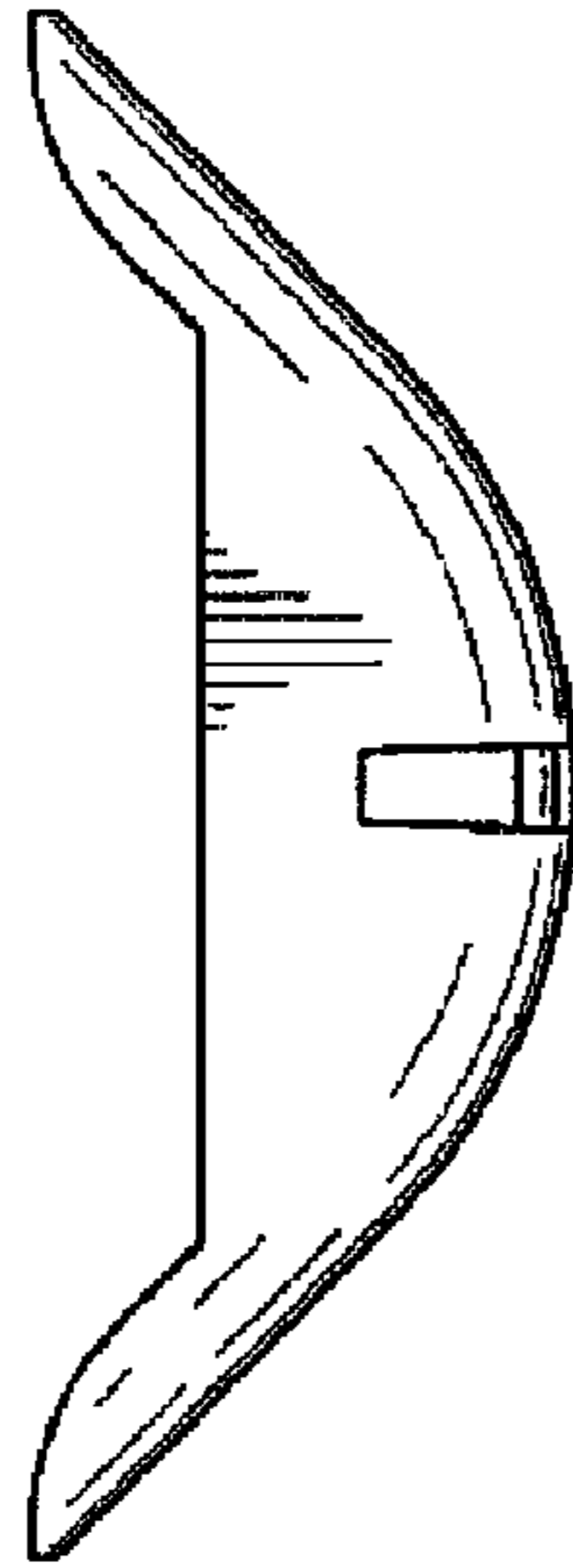

Fig. 3

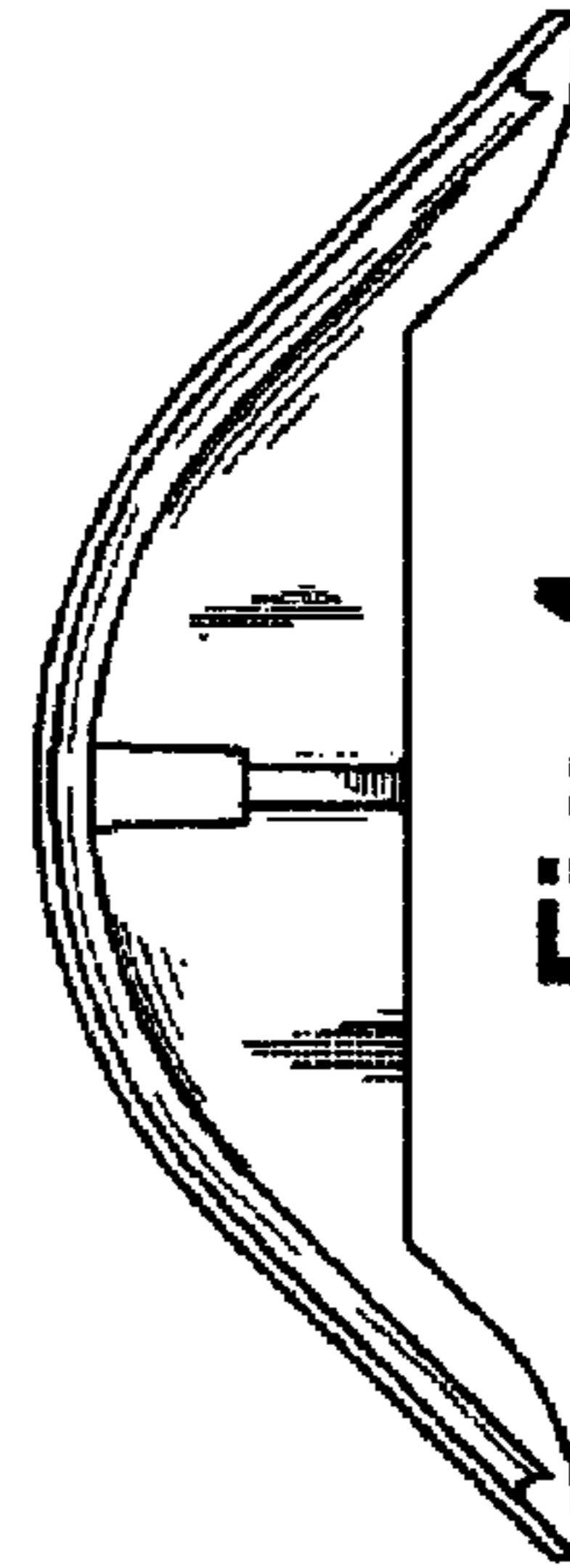

Fig. 4

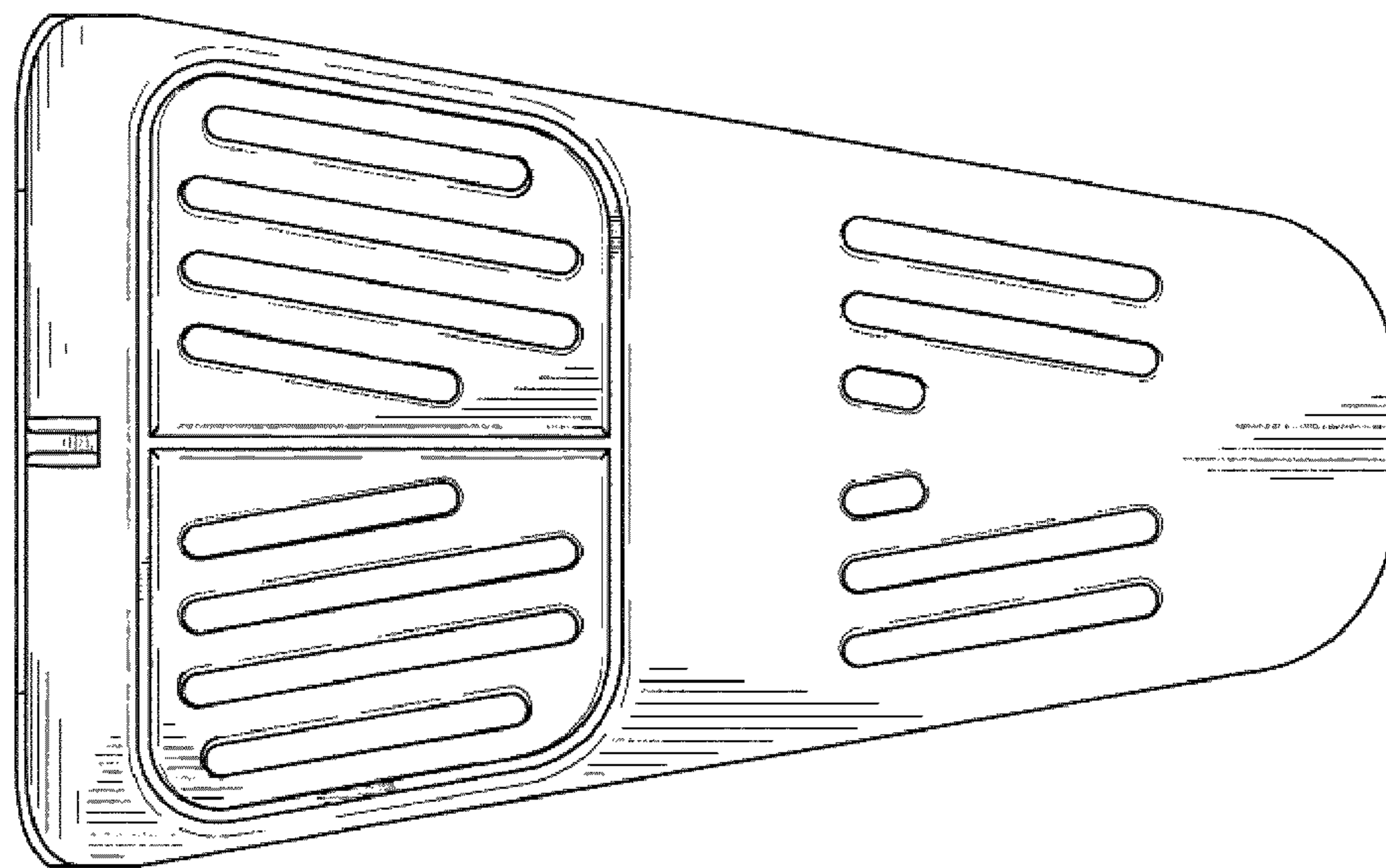

Fig. 5

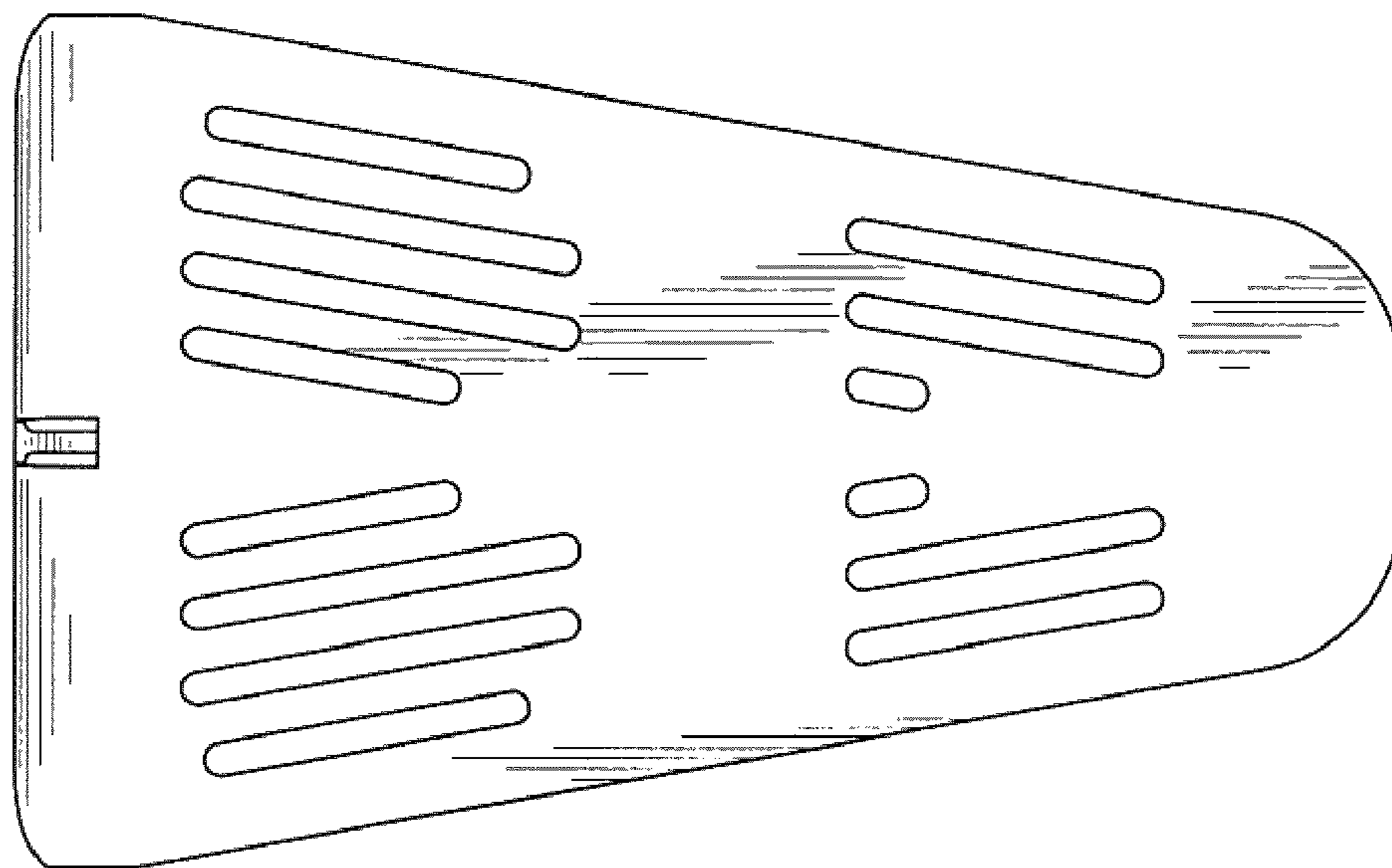

Fig. 6

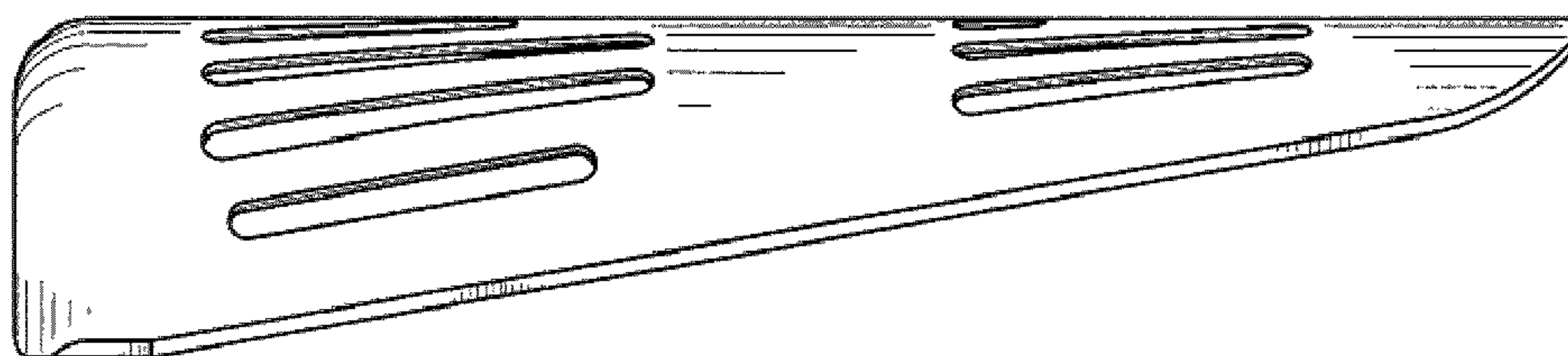

Fig. 7