



US00D622570S

(12) **United States Design Patent**
Miyagi et al.

(10) **Patent No.:** **US D622,570 S**

(45) **Date of Patent:** **** Aug. 31, 2010**

(54) **STAPLER**

(75) Inventors: **Sotaro Miyagi**, Tokyo (JP); **Takeshi Matsukawa**, Tokyo (JP)

(73) Assignee: **Plus Stationery Corp.**, Tokyo (JP)

(**) Term: **14 Years**

(21) Appl. No.: **29/318,141**

(22) Filed: **May 14, 2008**

(51) **LOC (9) Cl.** **19-02**

(52) **U.S. Cl.** **D8/50**

(58) **Field of Classification Search** D8/49,
D8/50, 61, 68, 69; D19/72, 73, 65, 69; D21/532;
D24/145; 7/158, 160; 227/4, 5, 6, 7, 8, 120,
227/127, 128, 131, 132, 134, 144, 156, 175.1;
606/139, 143, 153, 219

See application file for complete search history.

(56) **References Cited**

U.S. PATENT DOCUMENTS

D333,957 S *	3/1993	Chan	D8/50
D352,435 S *	11/1994	Chi	D8/50
D394,592 S *	5/1998	Brunsdon et al.	D8/50
D401,825 S	12/1998	Parsey et al.		
D414,091 S *	9/1999	Rellinger	D8/50
D429,453 S *	8/2000	Imboden et al.	D8/50
D434,443 S *	11/2000	Mori et al.	D19/72
D447,396 S *	9/2001	Arns	D8/50
D468,981 S *	1/2003	Nolan	D8/50
D470,025 S *	2/2003	Joss et al.	D8/50
D471,414 S *	3/2003	Chan	D8/50
D472,436 S *	4/2003	Scola et al.	D8/50
D478,486 S *	8/2003	Scola et al.	D8/50
6,626,346 B2 *	9/2003	Jairam et al.	227/127
D480,287 S *	10/2003	Scola et al.	D8/50
D482,584 S *	11/2003	Racamier	D8/50
D487,006 S *	2/2004	Lee	D8/50

D502,851 S *	3/2005	Sauter et al.	D8/50
D503,321 S *	3/2005	Harris	D8/50
6,966,479 B2	11/2005	Tanaka et al.		
D513,159 S *	12/2005	Marks et al.	D8/50
D514,906 S *	2/2006	Marks et al.	D8/50
7,124,924 B2	10/2006	Marks		
D531,866 S	11/2006	Harris et al.		
D533,756 S *	12/2006	Chang	D8/50
7,322,504 B2	1/2008	Chen		
D567,043 S *	4/2008	Marks et al.	D8/50
D570,170 S *	6/2008	Kent et al.	D8/50
2006/0144895 A1	7/2006	Kirby et al.		
2007/0272721 A1	11/2007	Marks		

* cited by examiner

Primary Examiner—Cathron C Brooks

Assistant Examiner—Austin Murphy

(74) *Attorney, Agent, or Firm*—William J. Sapone; Coleman Sudol Sapone P.C.

(57) **CLAIM**

We claim the ornamental design for a stapler, as shown and described.

DESCRIPTION

FIG. 1 is a right side view of the stapler showing our new design;

FIG. 2 is a left side view thereof;

FIG. 3 is a rear view thereof;

FIG. 4 is a front view thereof;

FIG. 5 is a top view thereof;

FIG. 6 is a bottom view thereof; and,

FIG. 7 is a perspective view thereof.

The broken lines showing various features in the drawings are for illustrative purposes only and those features form no part of the claimed design.

1 Claim, 5 Drawing Sheets

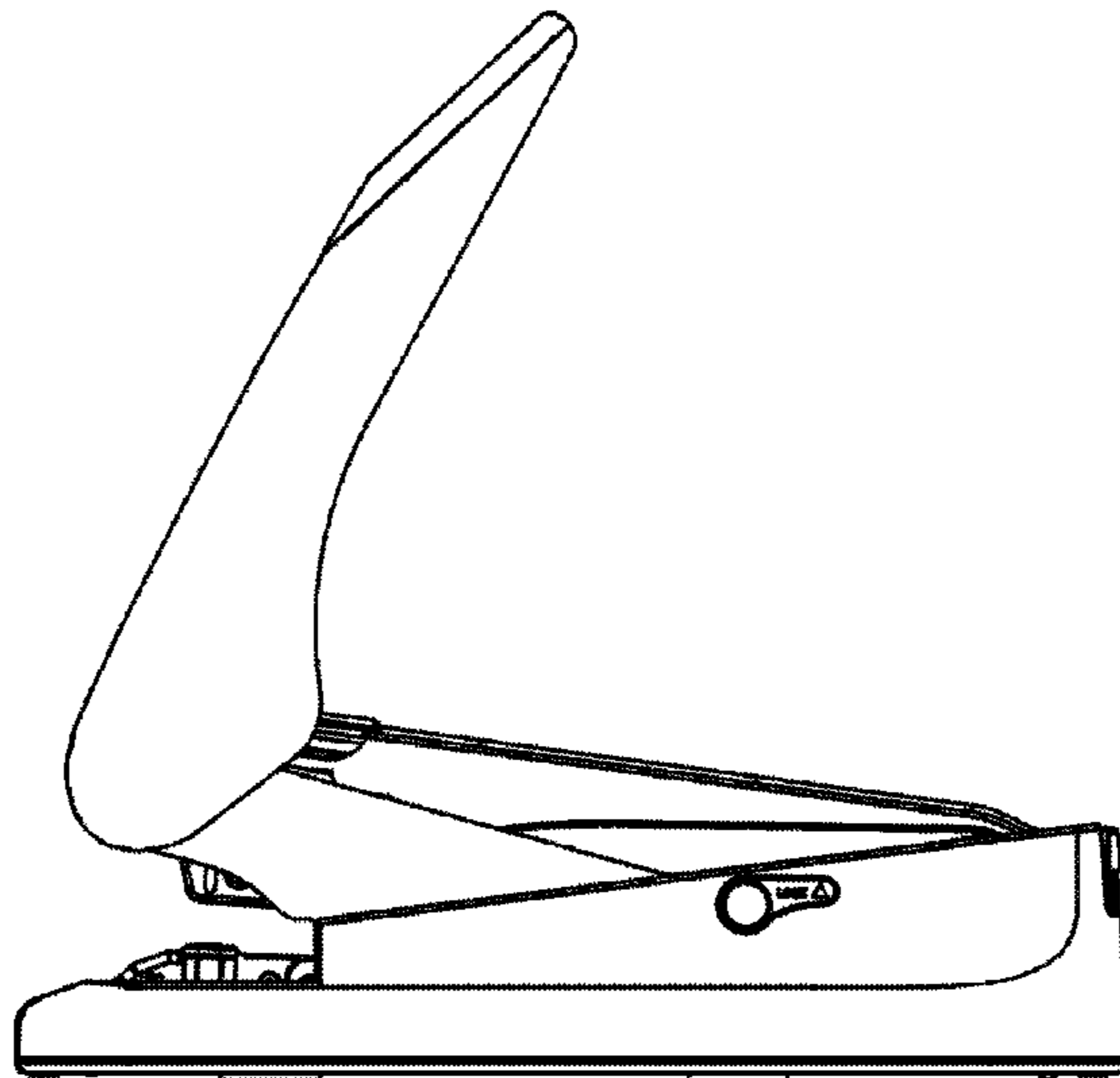

Fig. 1

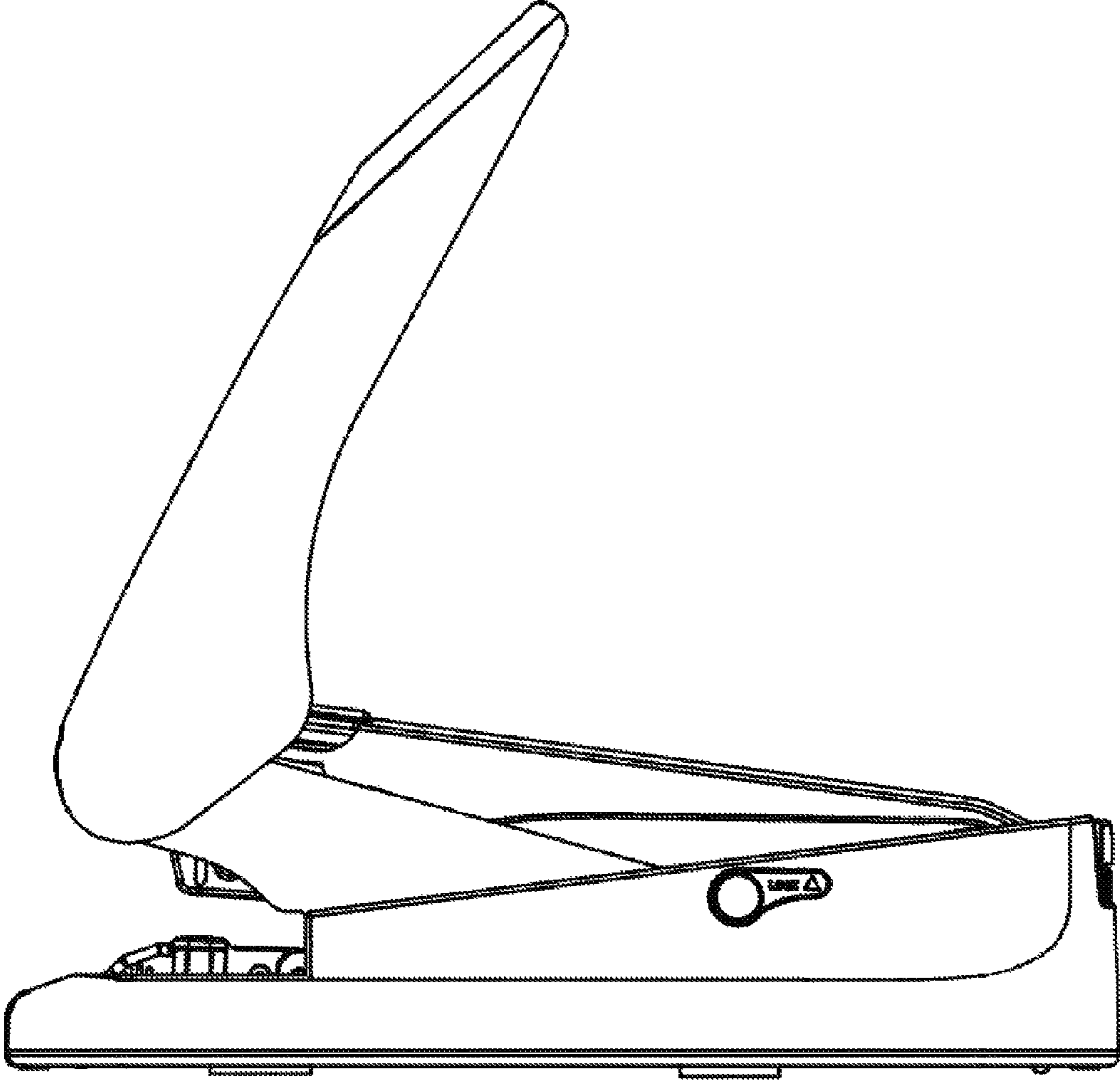
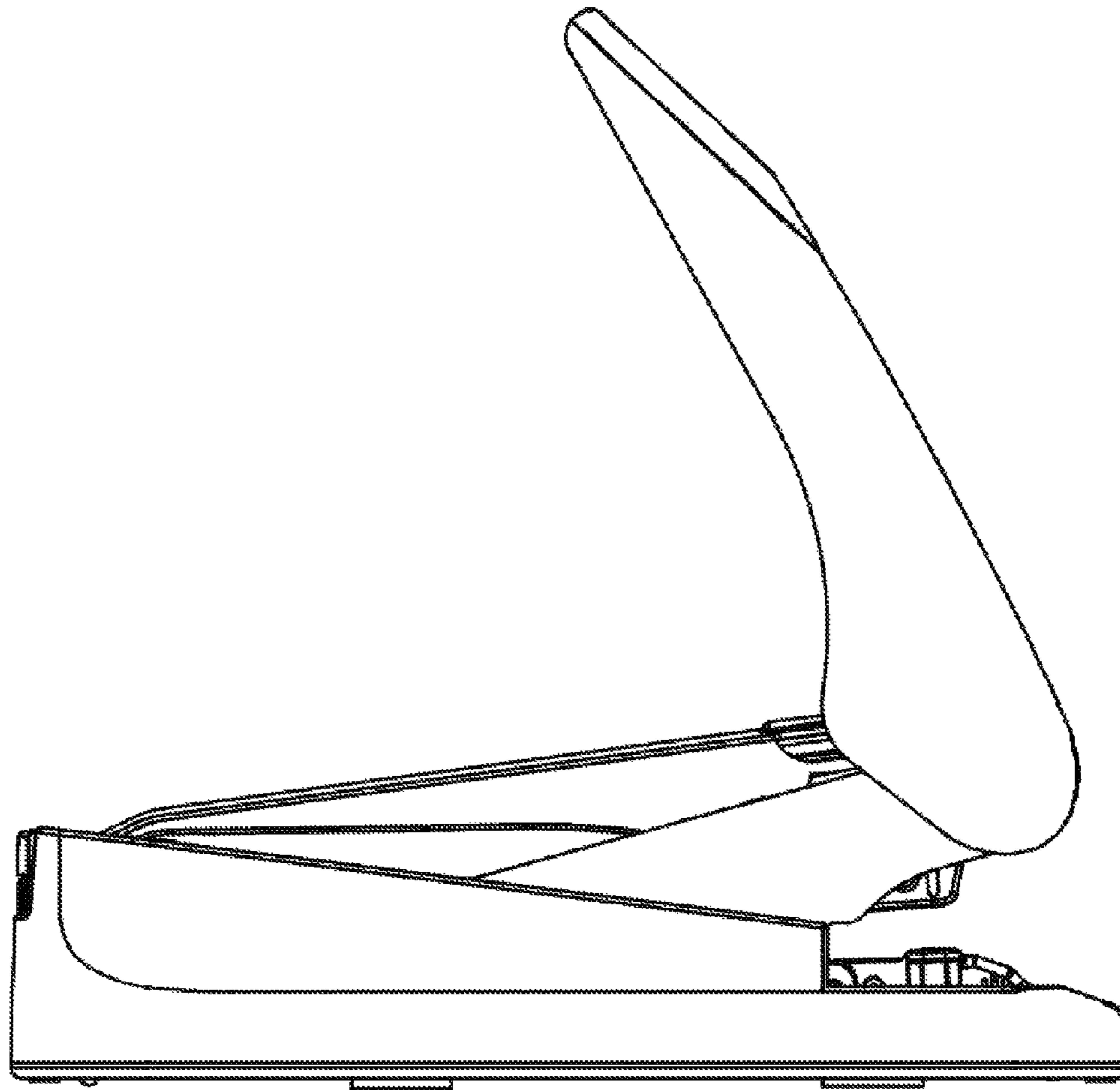

Fig. 2



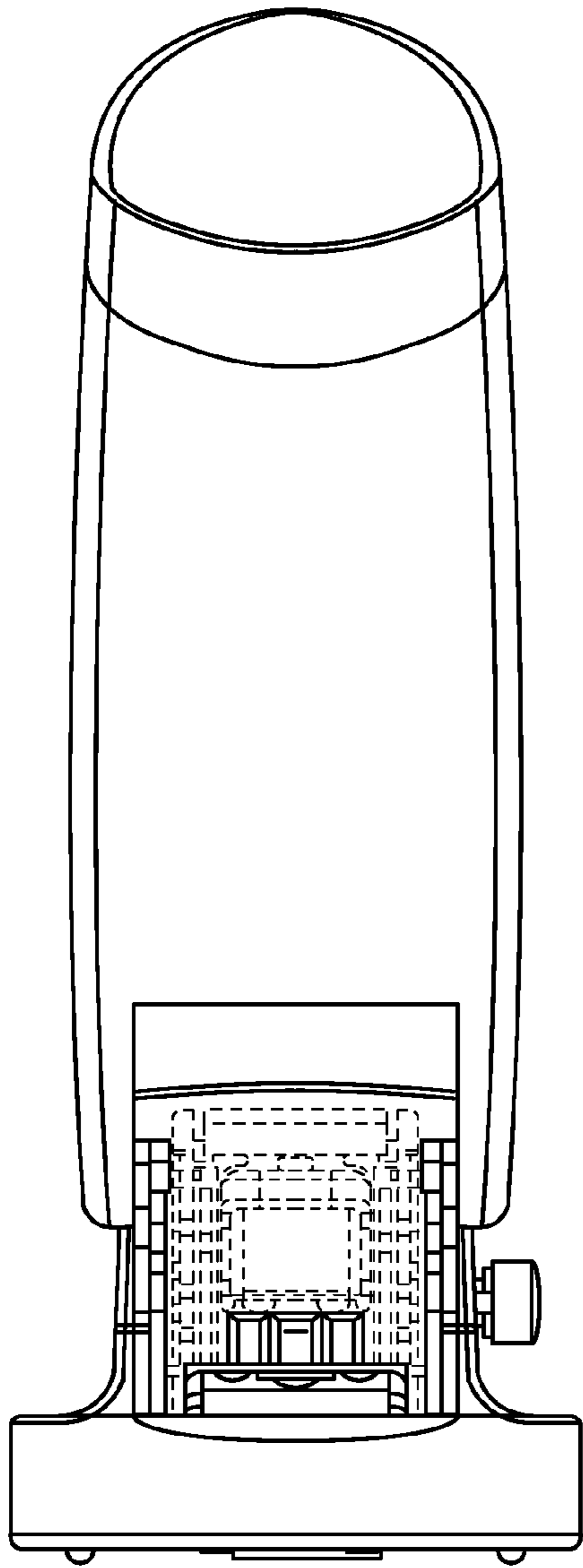

FIG. 3

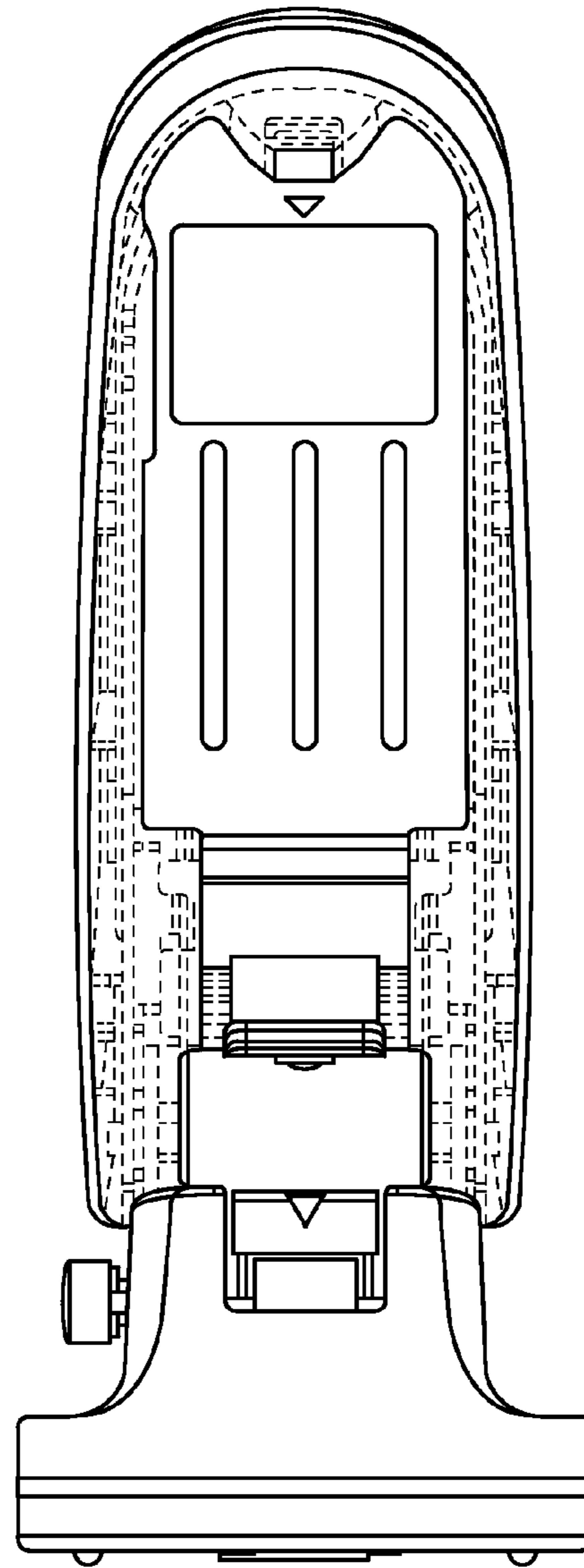

FIG. 4

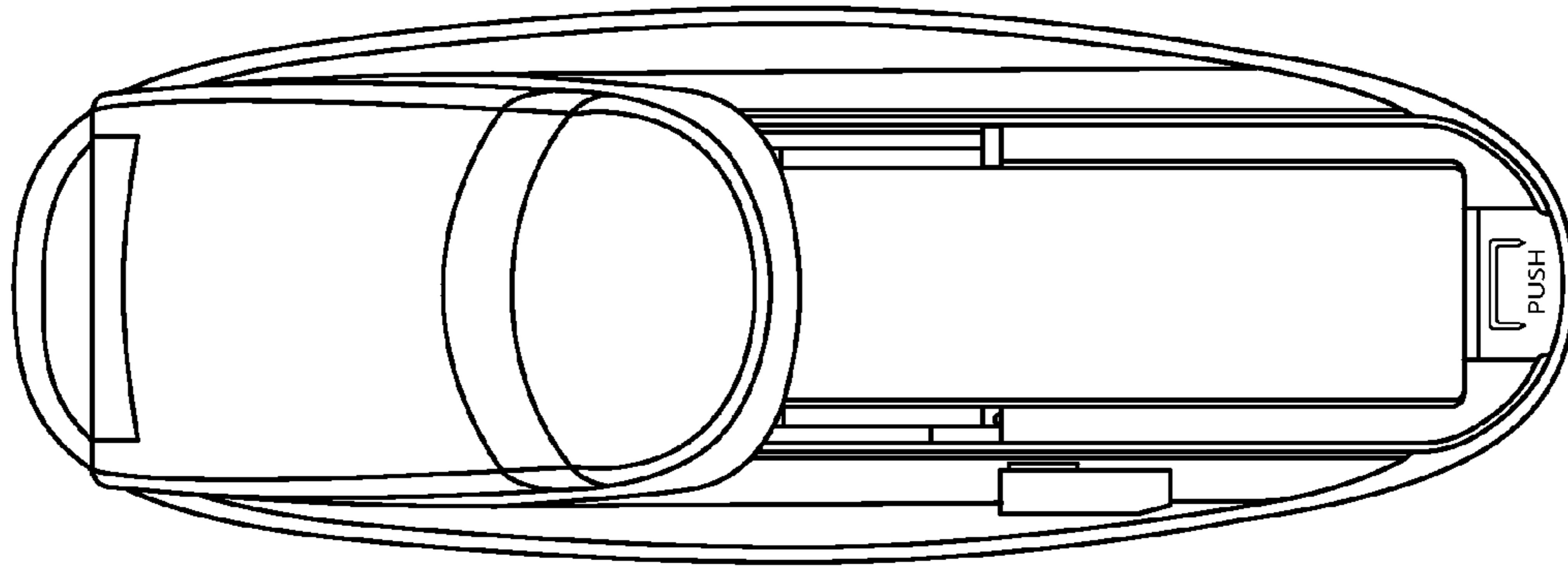

FIG. 5

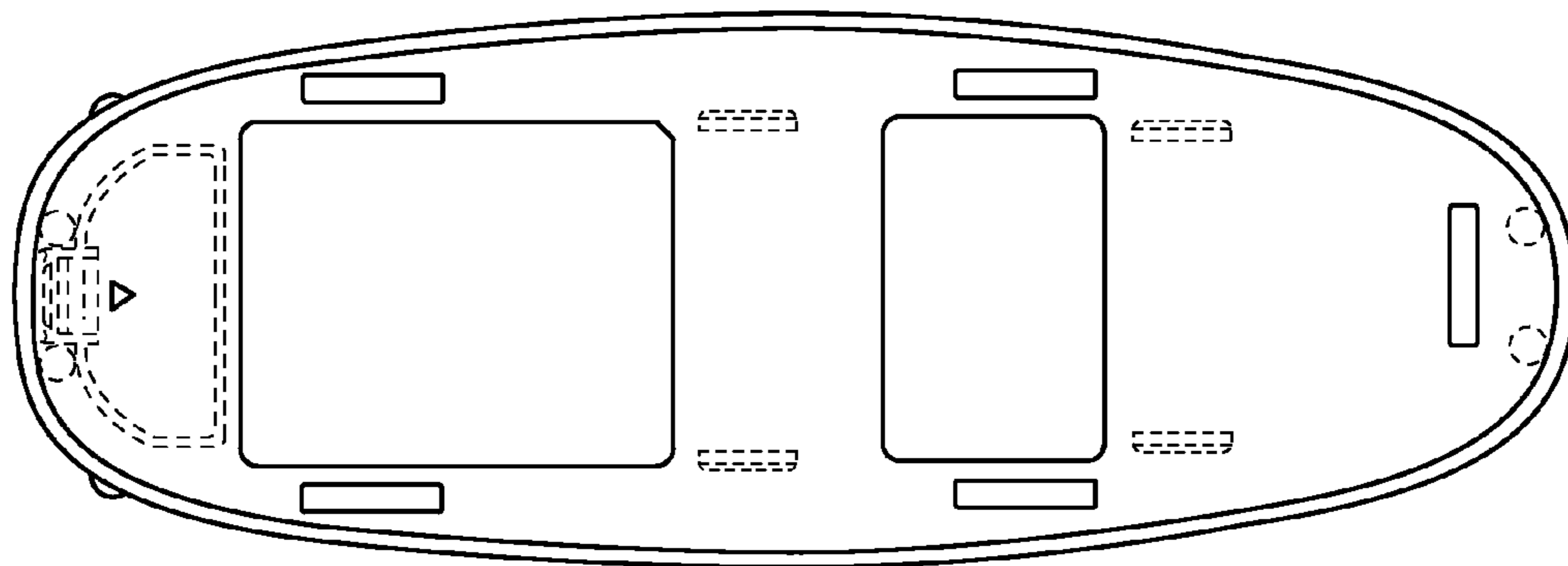

FIG. 6

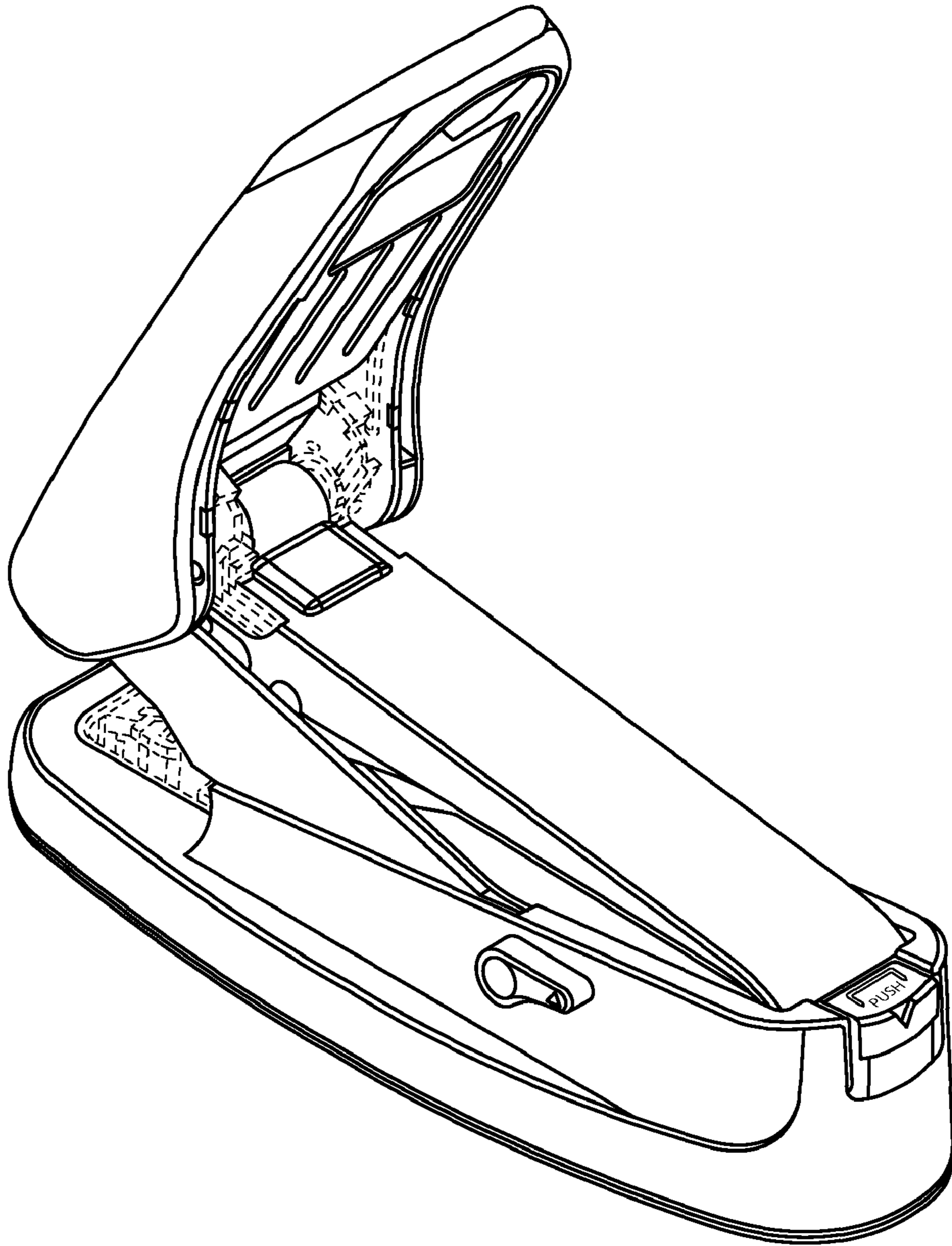

FIG. 7