

US00D622549S

(12) **United States Design Patent**
Carreno

(10) **Patent No.:** **US D622,549 S**

(45) **Date of Patent:** **** Aug. 31, 2010**

(54) **MUG**

(75) Inventor: **Alfredo Carreno**, Greece, NY (US)

(73) Assignee: **Thermos L.L.C.**, Rolling Meadows, IL (US)

(**) Term: **14 Years**

(21) Appl. No.: **29/350,860**

(22) Filed: **Nov. 24, 2009**

(51) **LOC (9) Cl.** **07-01**

(52) **U.S. Cl.** **D7/533; D7/510**

(58) **Field of Classification Search** D7/509-511,
D7/523, 533, 536, 608; D9/502, 504; 220/592.16,
220/715, 669; 215/315, 382, 373, 384; 229/400,
229/403

See application file for complete search history.

(56) **References Cited**

U.S. PATENT DOCUMENTS

4,184,604	A *	1/1980	Amberg et al.	220/254.3
4,412,629	A *	11/1983	Dart et al.	220/711
D356,503	S *	3/1995	Mueller et al.	D7/523
D386,644	S *	11/1997	Orrico et al.	D7/300
D395,118	S *	6/1998	Cramer et al.	D34/39
D421,877	S *	3/2000	La Torre et al.	D7/510
D457,034	S *	5/2002	Bodum	D7/510
D488,348	S *	4/2004	Liu	D7/523

D490,272	S *	5/2004	Rohe	D7/510
D547,611	S *	7/2007	Seum et al.	D7/511
D571,154	S *	6/2008	Pearson	D7/533
D588,871	S *	3/2009	Miller et al.	D7/510
D602,308	S *	10/2009	Alviar et al.	D7/510
D604,103	S *	11/2009	Alviar et al.	D7/533
D609,970	S *	2/2010	Richau et al.	D7/510

* cited by examiner

Primary Examiner—Marianne Pandozzi

(74) *Attorney, Agent, or Firm*—Wood, Phillips, Katz, Clark & Mortimer

(57) **CLAIM**

The ornamental design for a mug, as shown and described.

DESCRIPTION

FIG. 1 is a perspective view from above and to the front right of the mug embodying the ornamental design;

FIG. 2 is a perspective view from below and to the left rear of the mug;

FIG. 3 is a right side elevation view of the mug, with the left side elevation view being a mirror image;

FIG. 4 is a front elevation view of the mug;

FIG. 5 is a back elevation view of the mug;

FIG. 6 is a top view of the mug; and,

FIG. 7 is a bottom view of the mug.

1 Claim, 3 Drawing Sheets

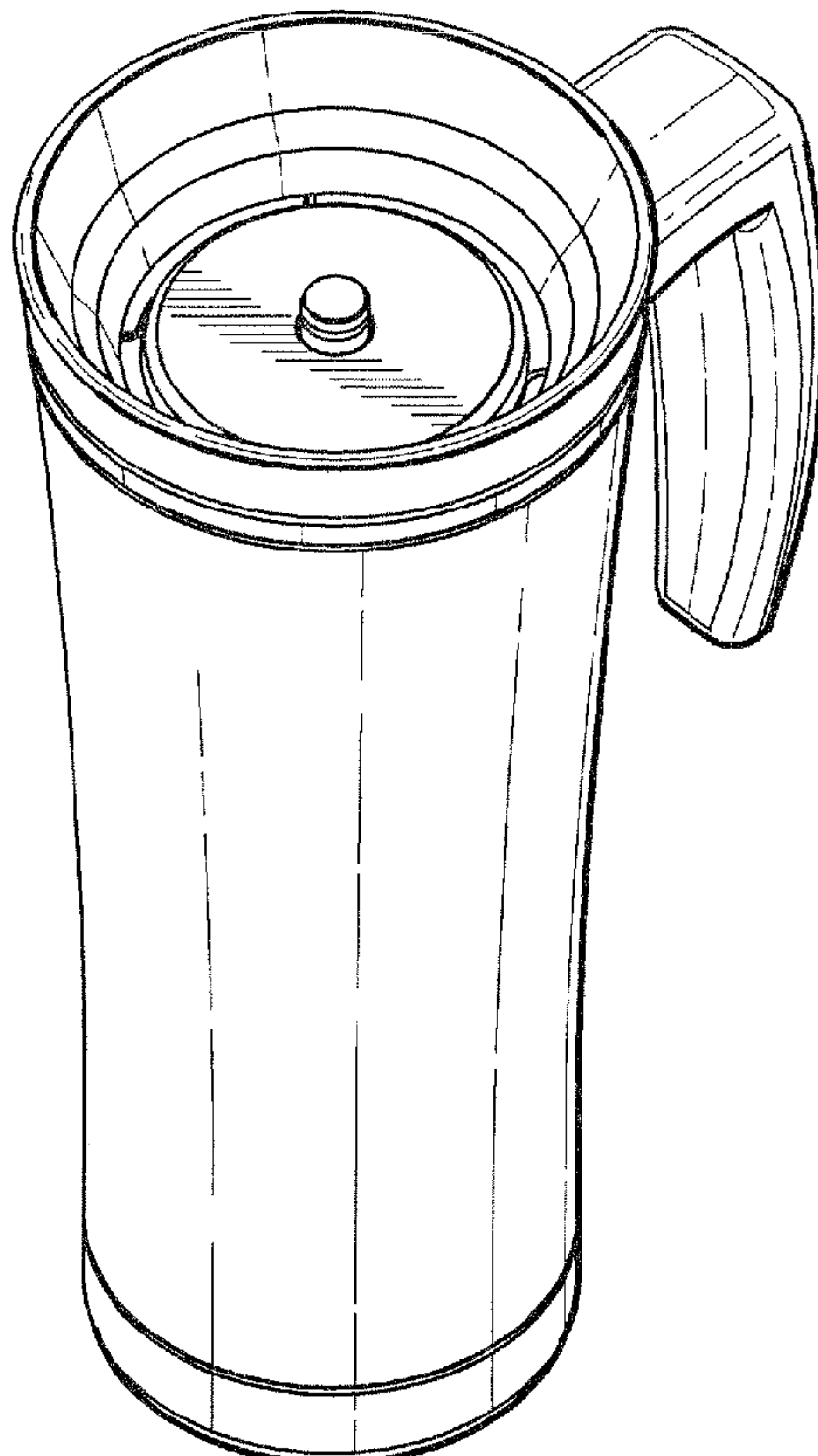

Fig. 1

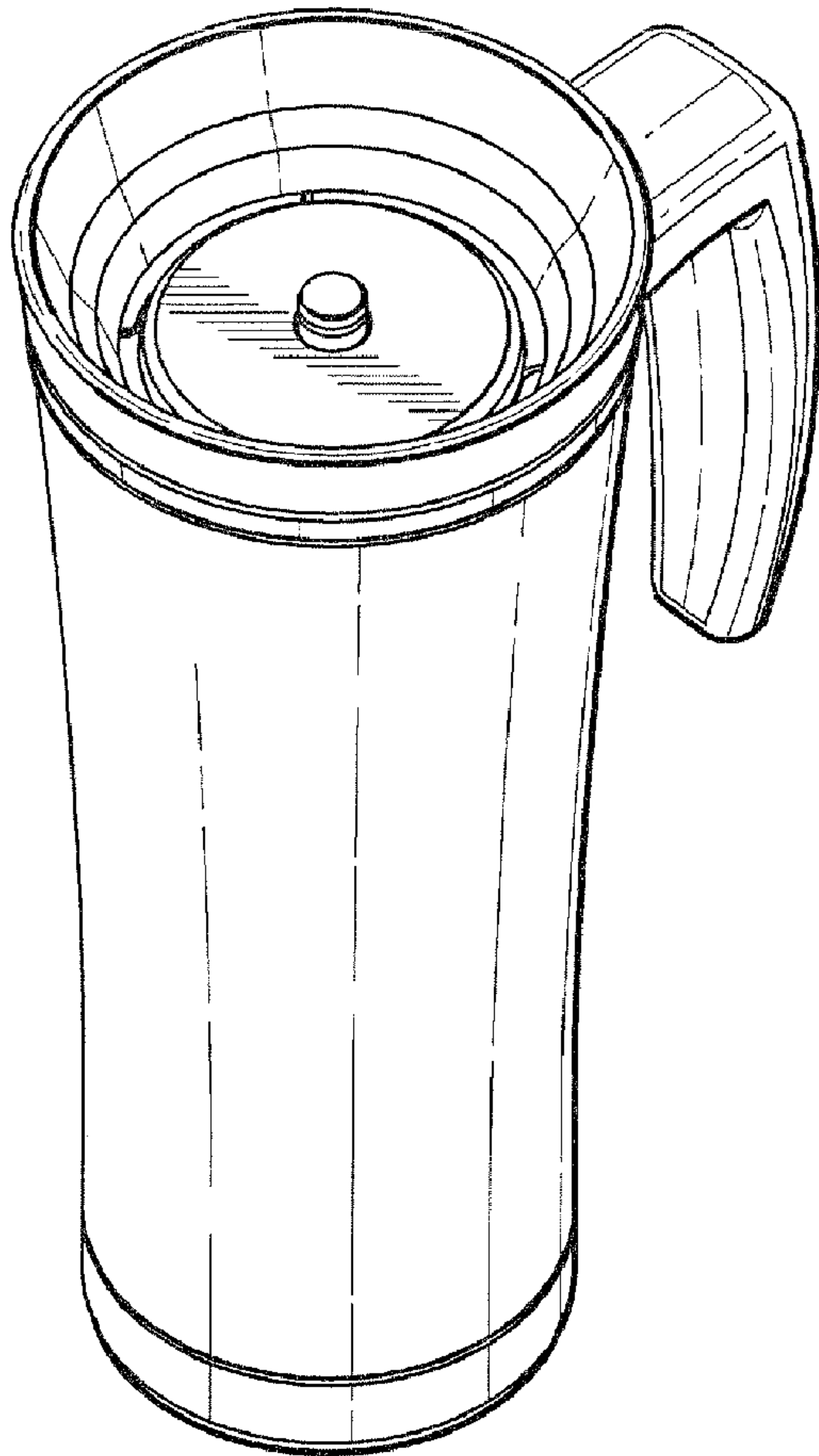

Fig. 2

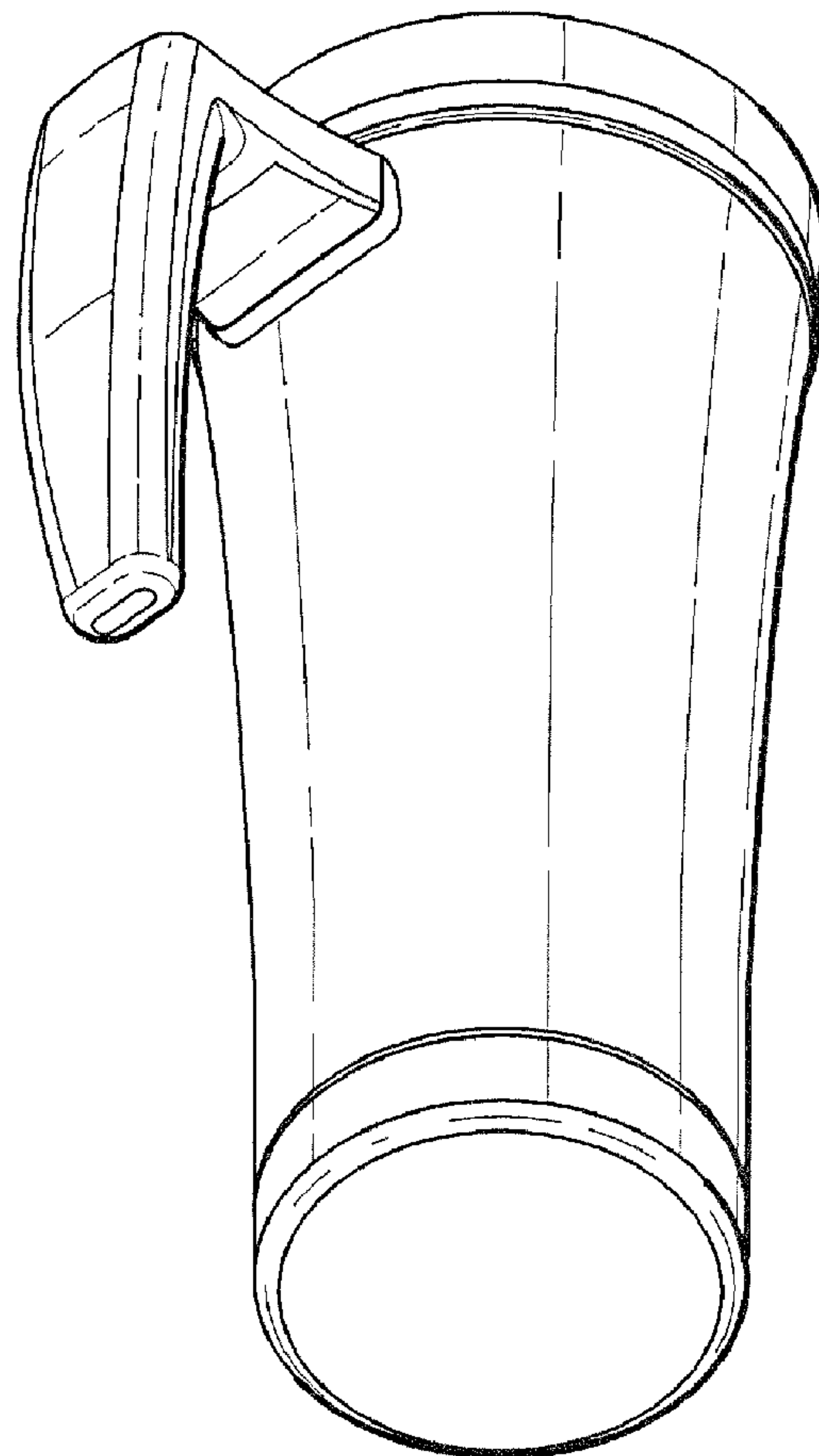

Fig. 3

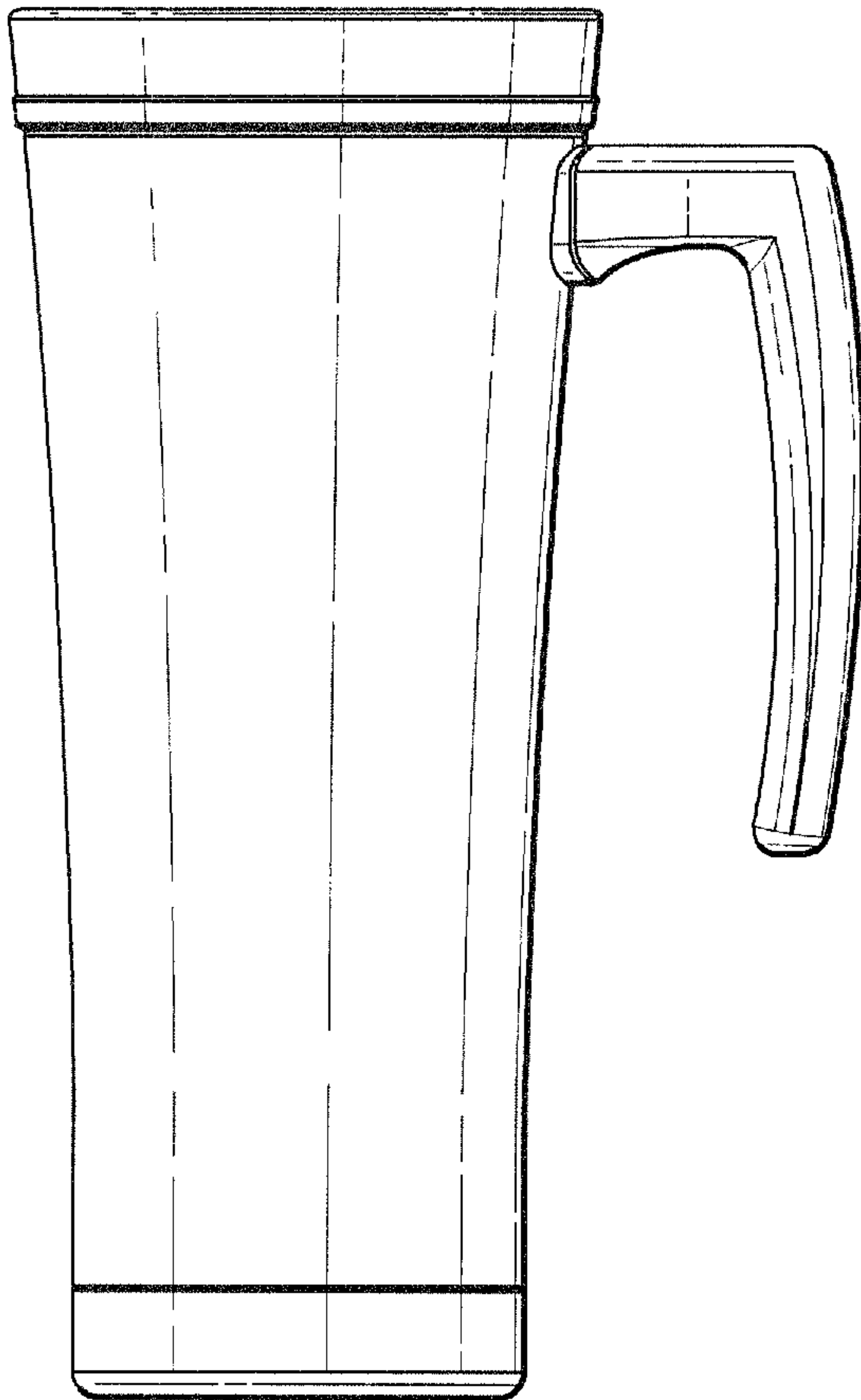

Fig. 4

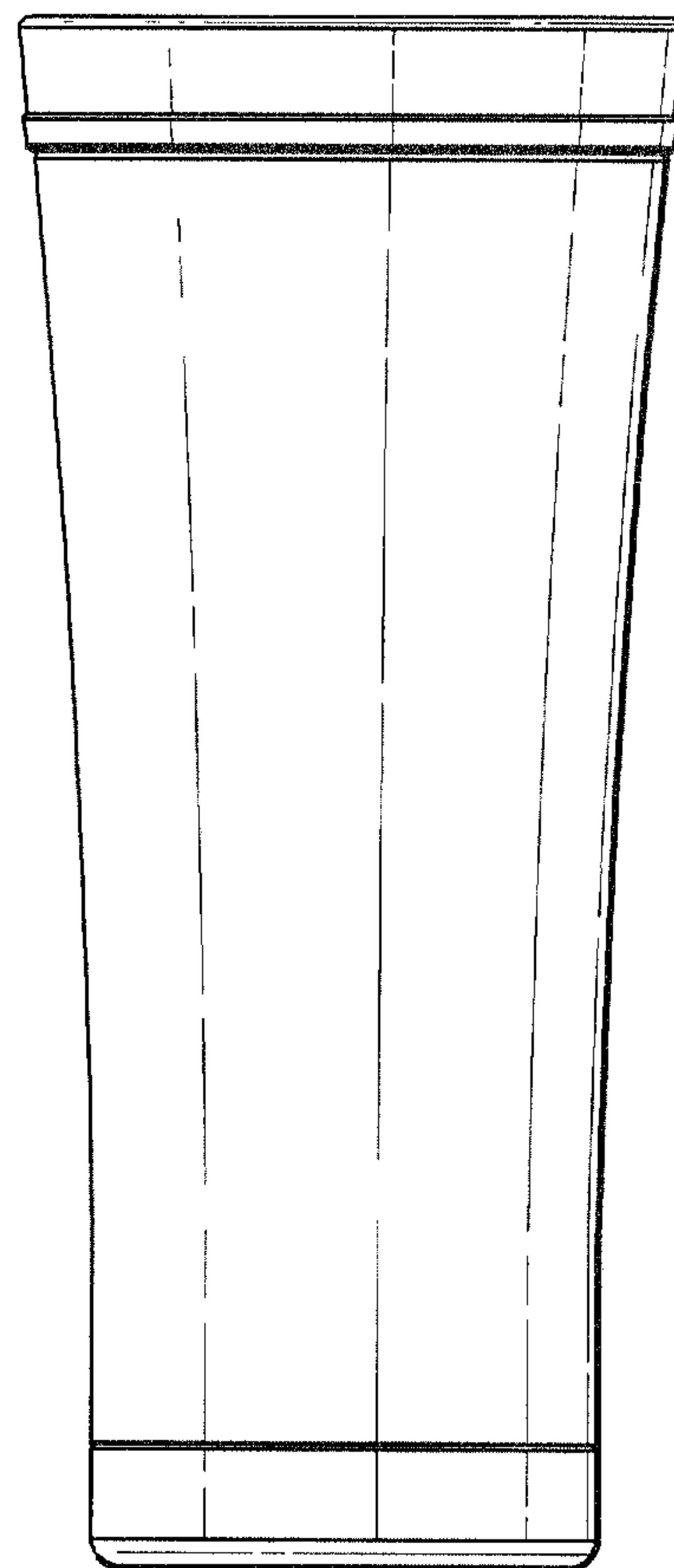

Fig. 5

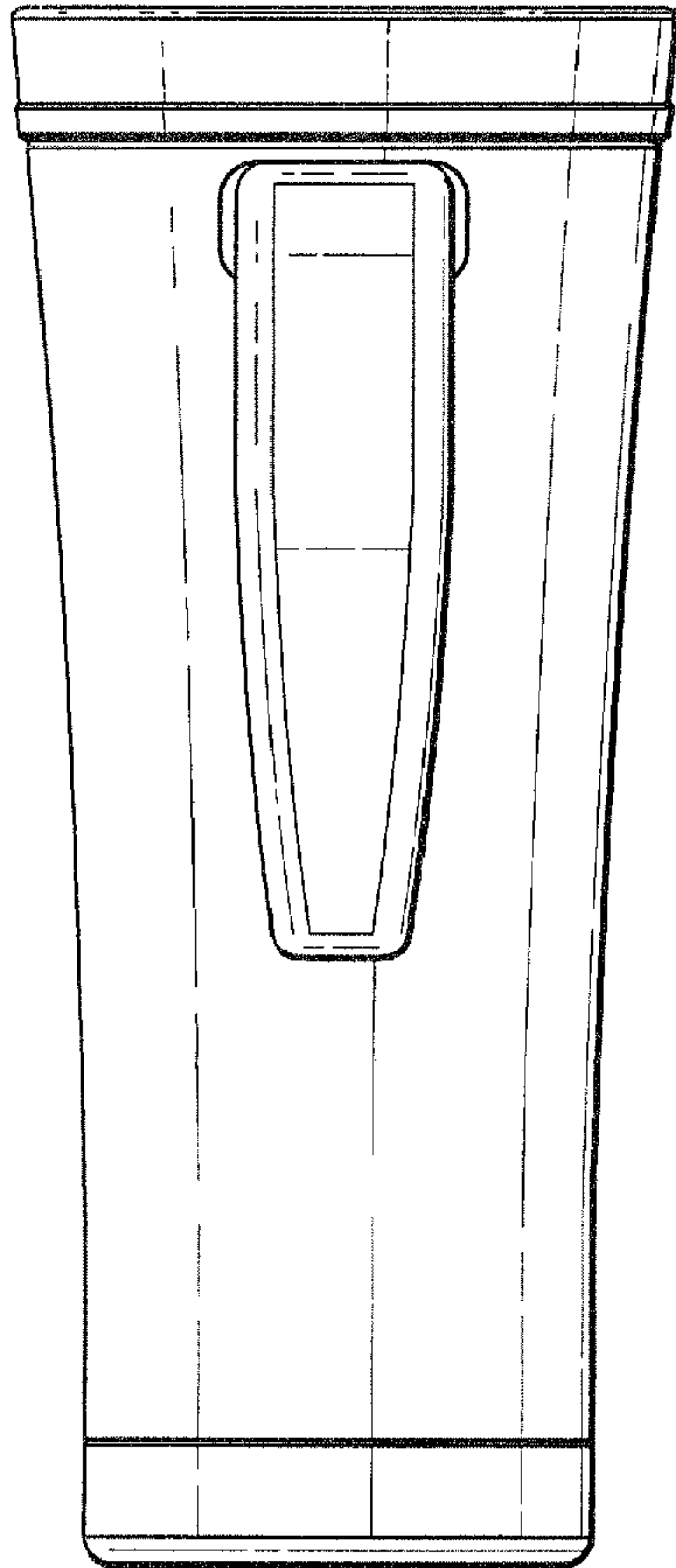

Fig. 6

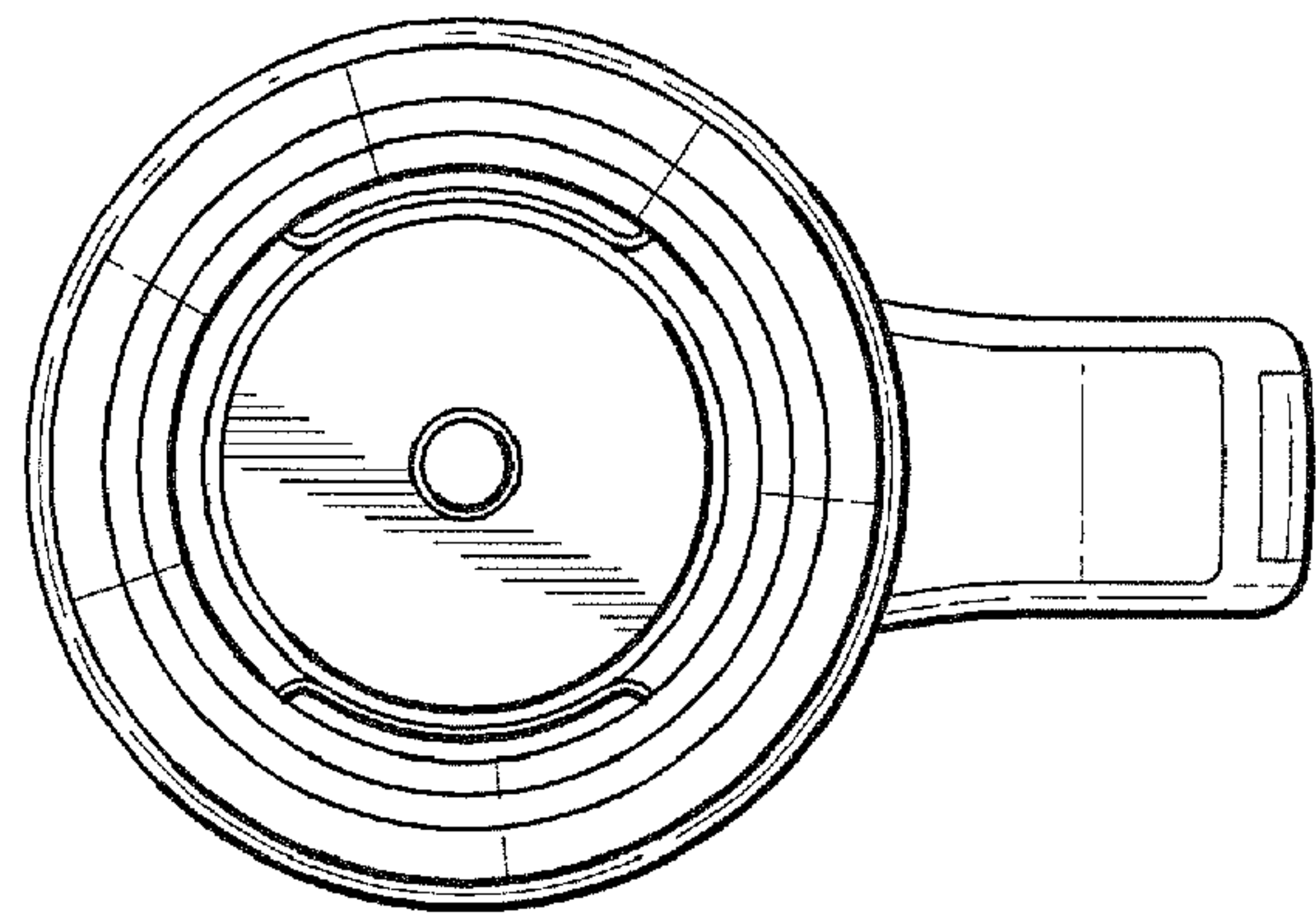

Fig. 7

