



US00D622546S

(12) **United States Design Patent**
Bodum

(10) **Patent No.:** **US D622,546 S**

(45) **Date of Patent:** **** Aug. 31, 2010**

(54) **TRAVEL PRESS**

(75) Inventor: **Jørgen Bodum**, Meggen (CH)

(73) Assignee: **Pi-Design AG**, Triengen (CH)

(**) Term: **14 Years**

(21) Appl. No.: **29/336,678**

(22) Filed: **May 7, 2009**

(30) **Foreign Application Priority Data**

Nov. 7, 2008 (DK) DA 2008 00235

(51) **LOC (9) Cl.** **07-01**

(52) **U.S. Cl.** **D7/510; D7/532; D7/511**

(58) **Field of Classification Search** D7/507,
D7/509, 510, 511, 523, 532; 220/715, 707,
220/713, 592.16

See application file for complete search history.

(56) **References Cited**

U.S. PATENT DOCUMENTS

| | | | | |
|----------------|---------|----------------|-------|-----------|
| D458,081 S * | 6/2002 | Bodum | | D7/510 |
| D479,437 S * | 9/2003 | Gluck | | D7/523 |
| 6,763,964 B1 * | 7/2004 | Hurlbut et al. | | 220/254.3 |
| D502,844 S * | 3/2005 | Rohe | | D7/510 |
| D564,841 S * | 3/2008 | Clemens et al. | | D7/510 |
| D569,181 S * | 5/2008 | Homma | | D7/510 |
| D574,190 S * | 8/2008 | Homma | | D7/510 |
| D579,720 S * | 11/2008 | Rohe | | D7/510 |
| D586,182 S * | 2/2009 | Trombly | | D7/510 |
| D587,060 S * | 2/2009 | Tong Chi Chung | | D7/319 |
| D587,069 S * | 2/2009 | Bodum | | D7/510 |

| | | | | |
|--------------|---------|------------------|-------|--------|
| D589,751 S * | 4/2009 | Liu et al. | | D7/510 |
| D591,107 S * | 4/2009 | Dominique et al. | | D7/510 |
| D592,909 S * | 5/2009 | Alviar et al. | | D7/510 |
| D599,622 S * | 9/2009 | Gilbert et al. | | D7/538 |
| D604,103 S * | 11/2009 | Alviar et al. | | D7/533 |
| D606,364 S * | 12/2009 | Gilbert et al. | | D7/510 |
| D609,970 S * | 2/2010 | Richau et al. | | D7/510 |

* cited by examiner

Primary Examiner—Marianne Pandozzi

(74) *Attorney, Agent, or Firm*—Cowan, Liebowitz & Latman, PC

(57) **CLAIM**

The ornamental design for a travel press, as shown and described.

DESCRIPTION

FIG. 1 is a perspective view of the travel press showing my design thereof;

FIG. 2 is a front view thereof;

FIG. 3 is a back view thereof;

FIG. 4 is a right side view thereof;

FIG. 5 is a left side view thereof;

FIG. 6 is a top view thereof;

FIG. 7 is a bottom view thereof;

FIG. 8 is a sectional view thereof taken along line 8—8 of FIG. 6; and,

FIG. 9 is an enlarged top perspective view thereof, broken away for ease of illustration.

1 Claim, 9 Drawing Sheets

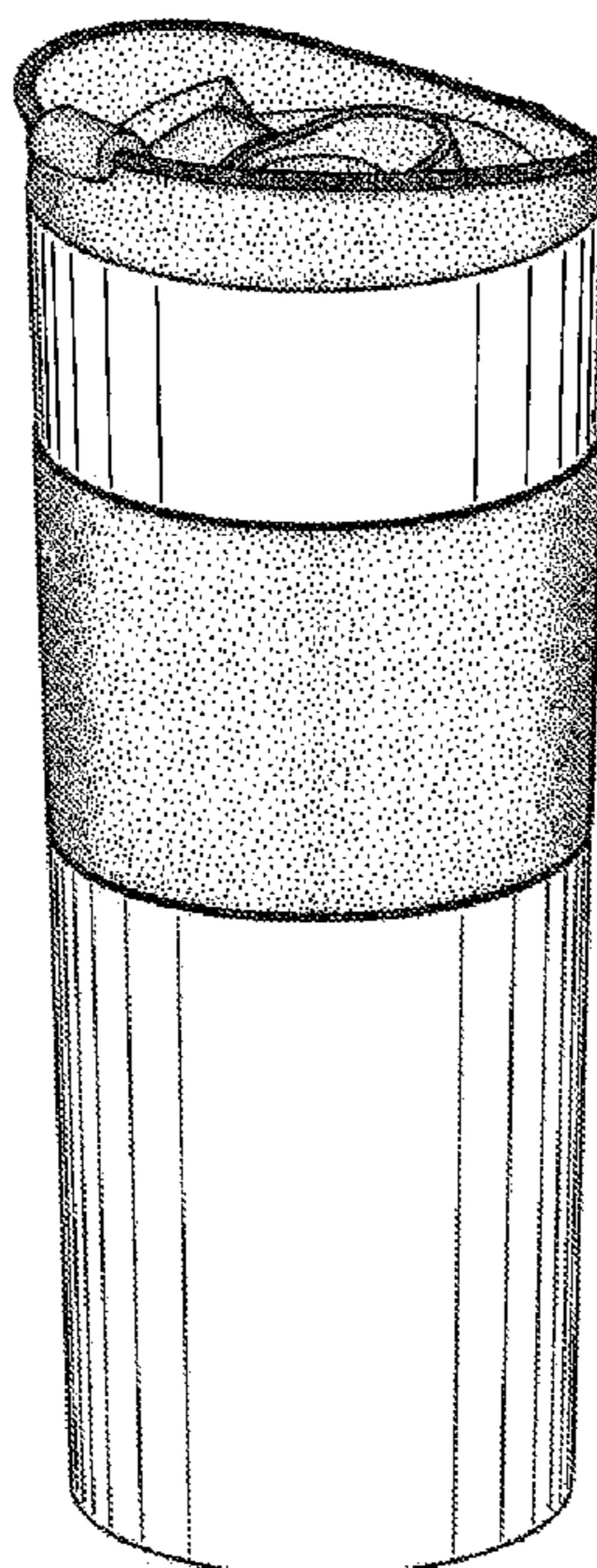

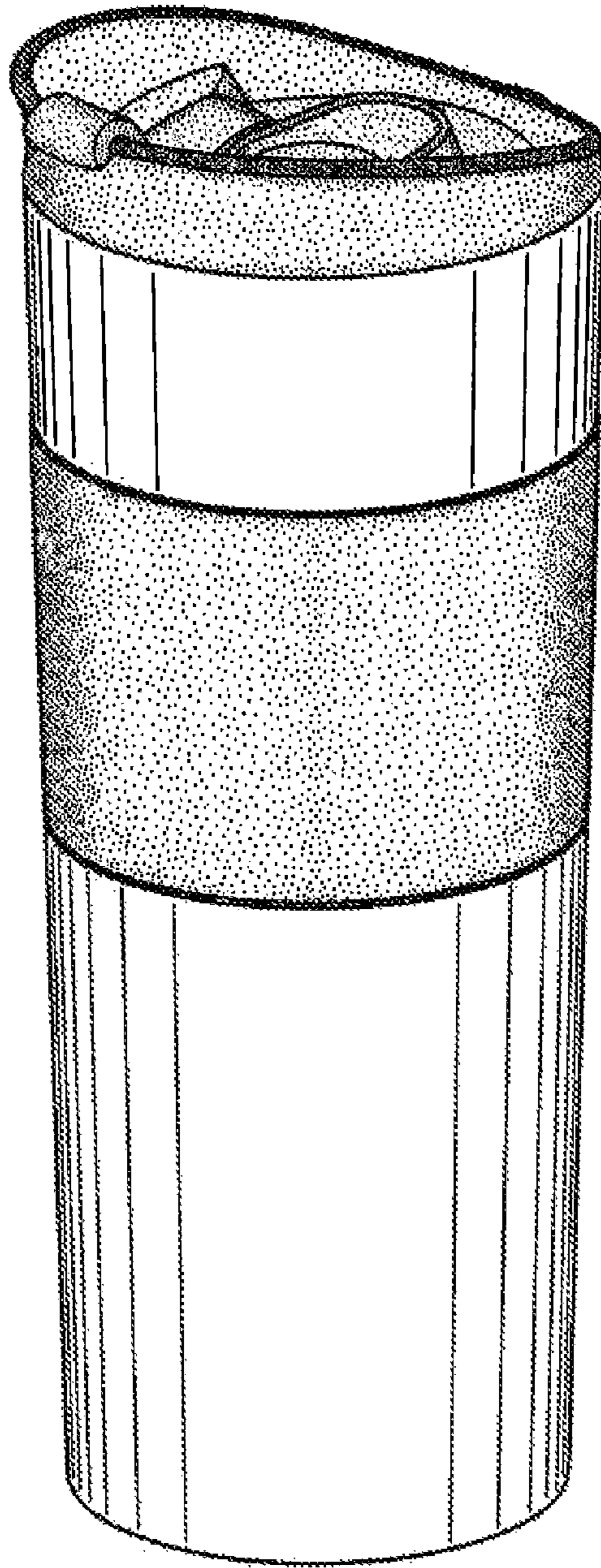

FIG. 1

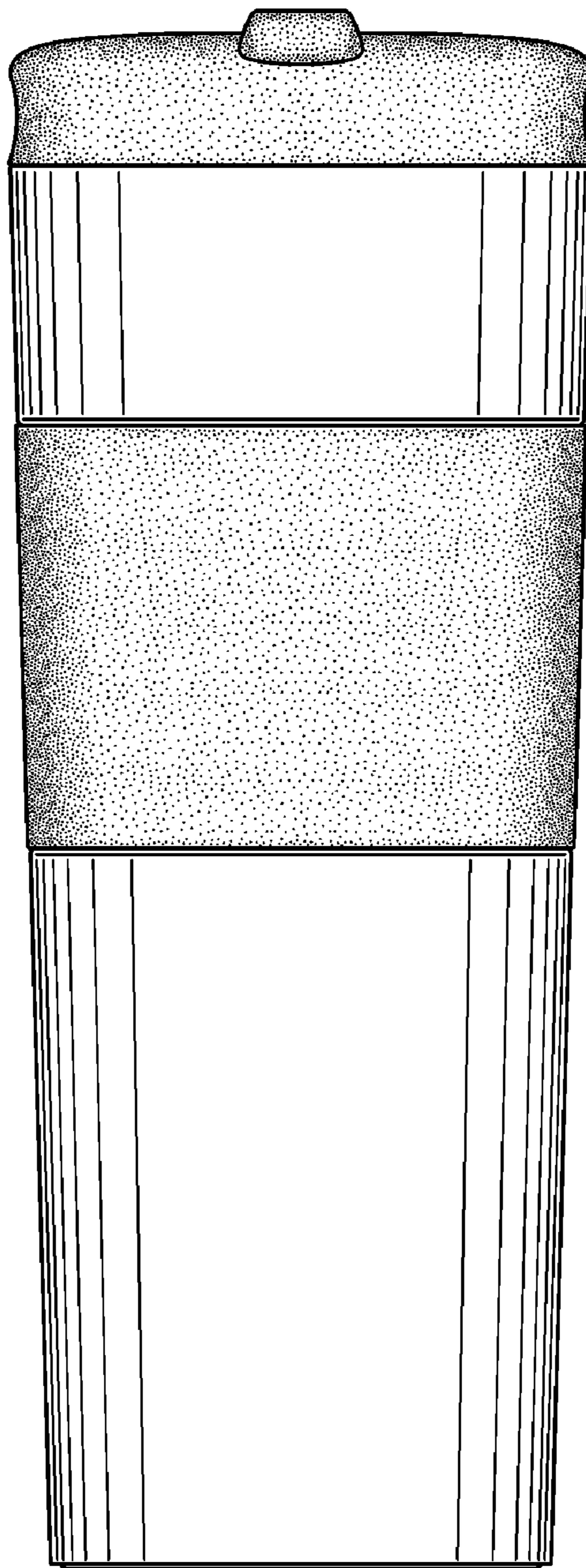

FIG. 2

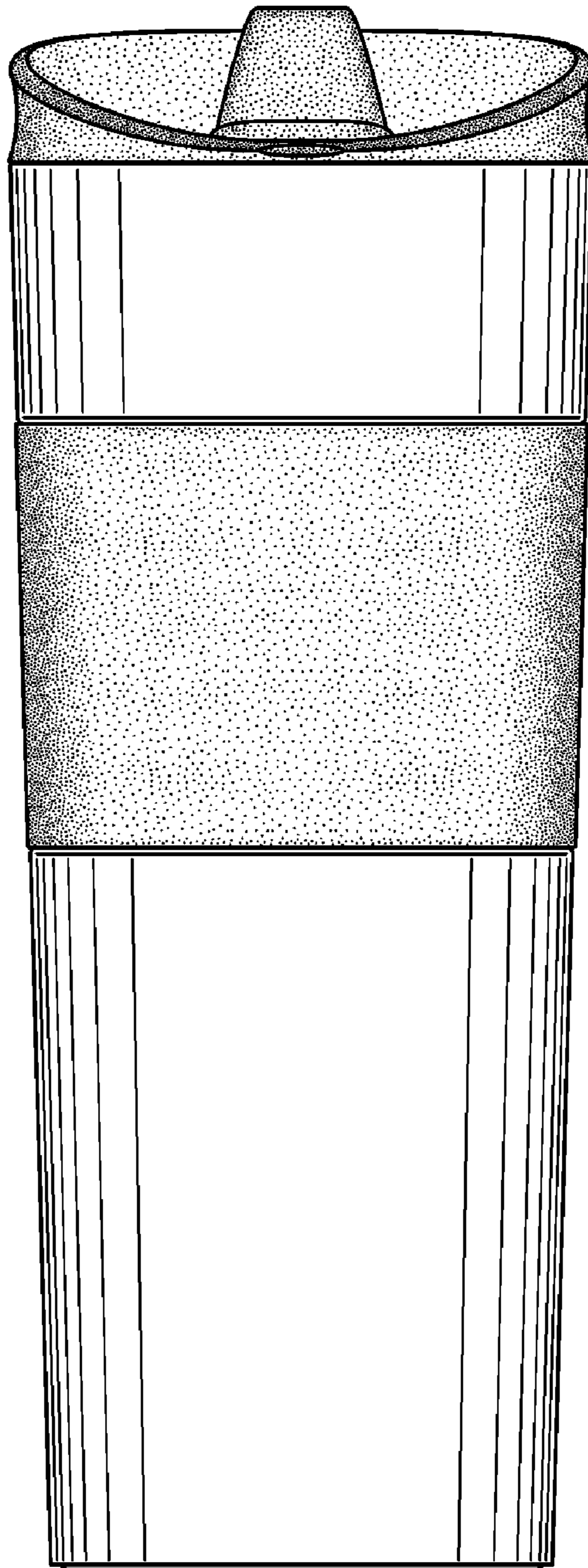

FIG. 3

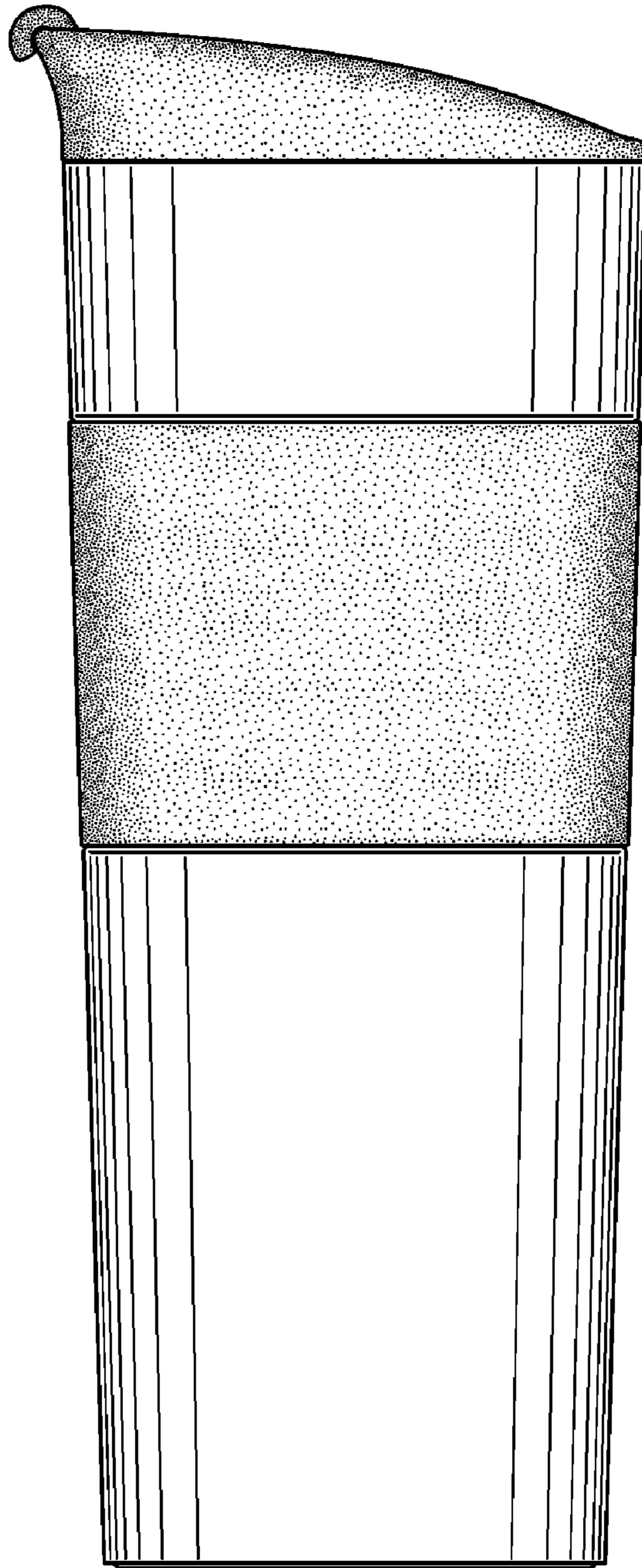

FIG. 4

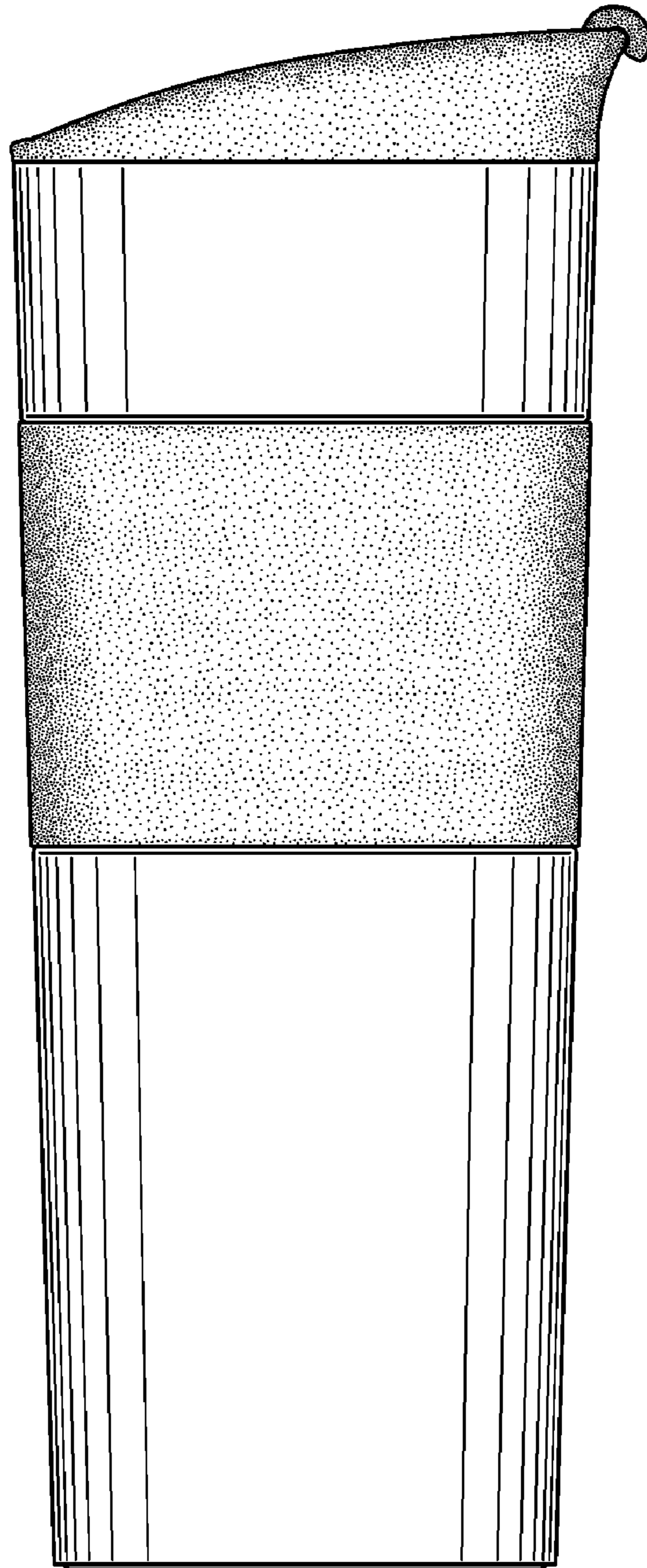

FIG. 5

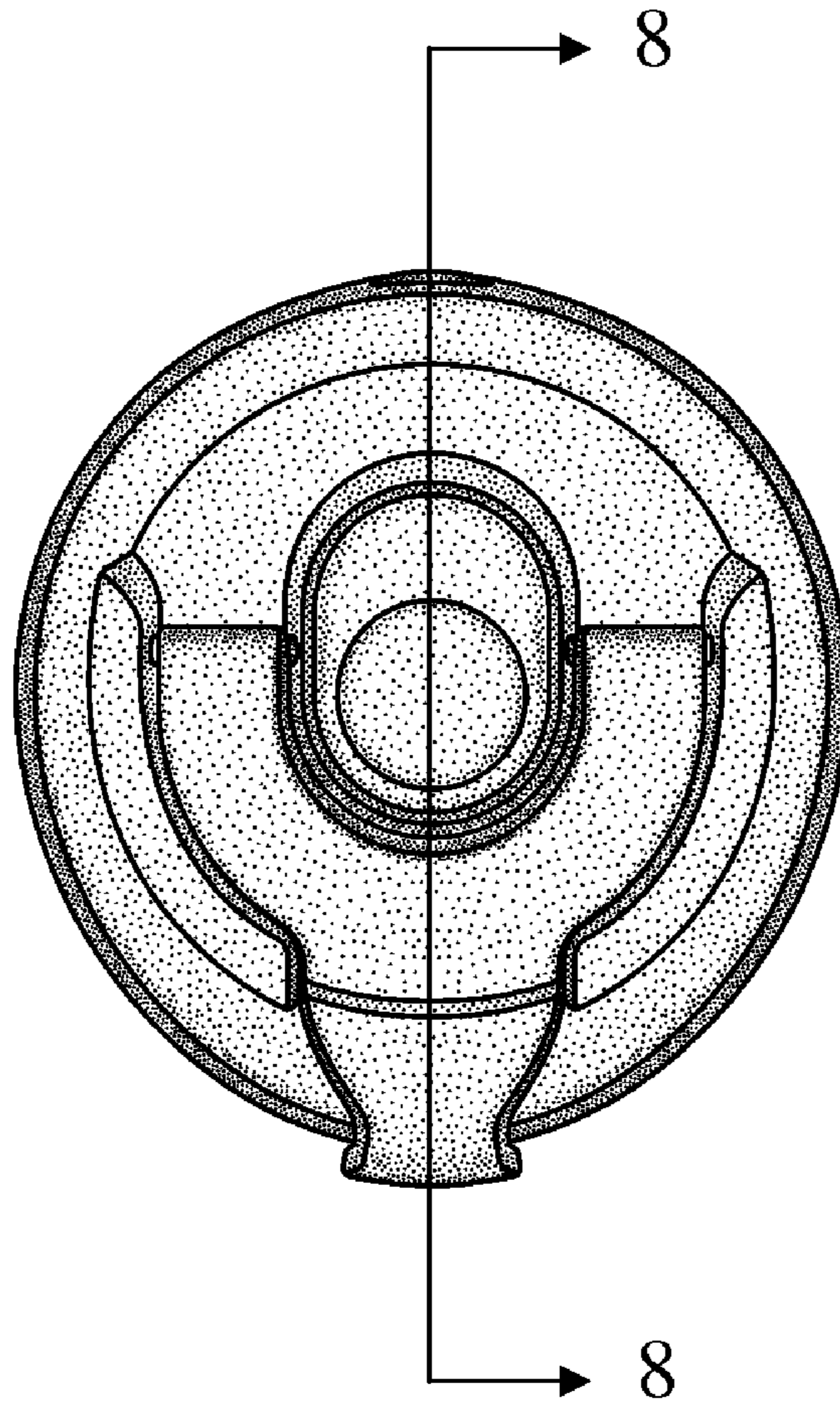

FIG. 6

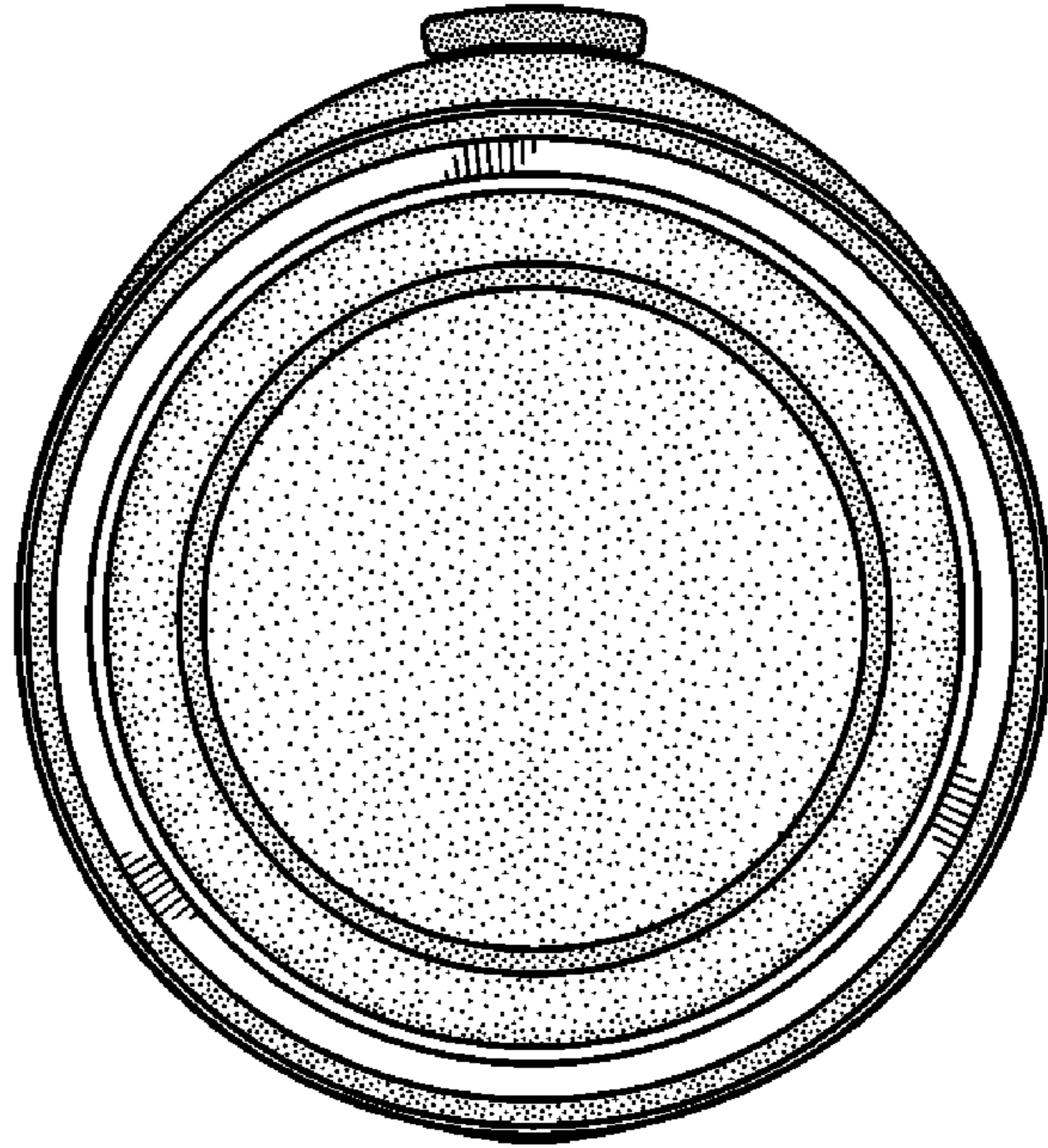

FIG. 7

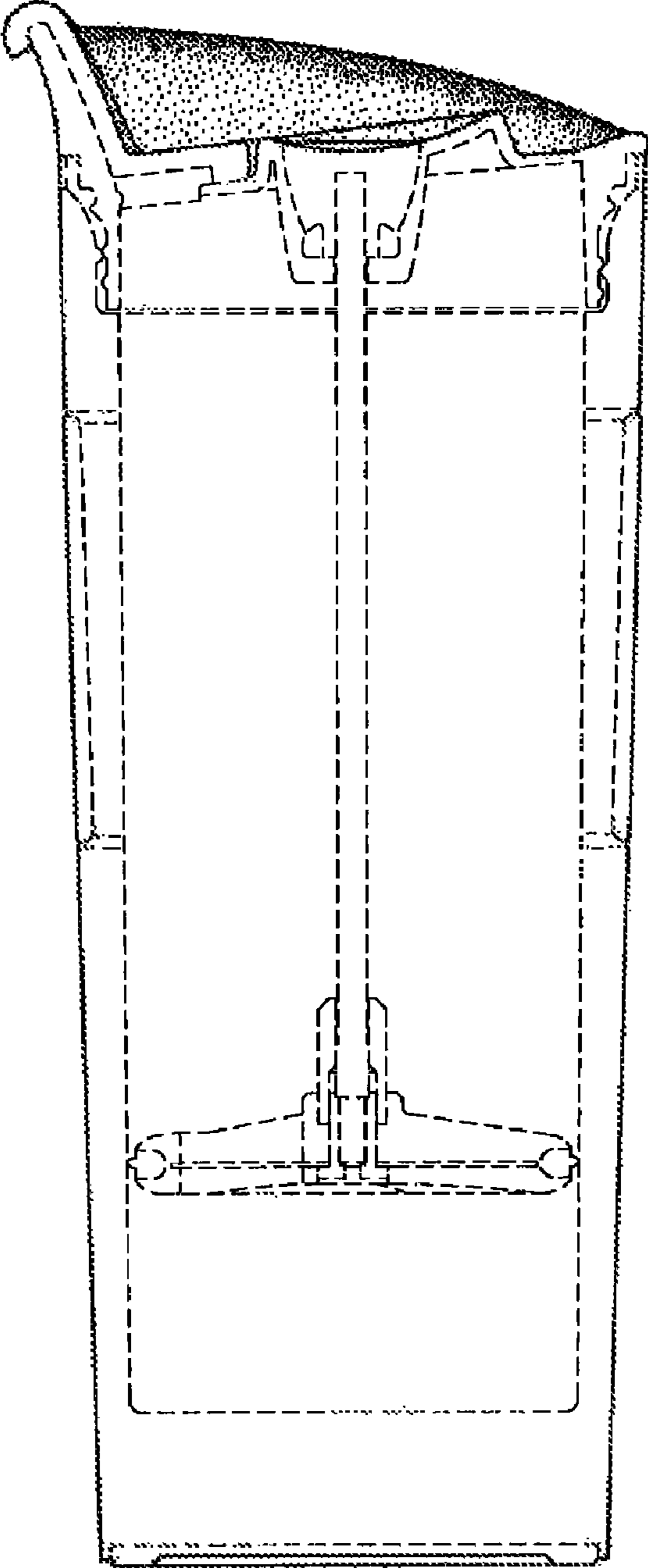

FIG. 8

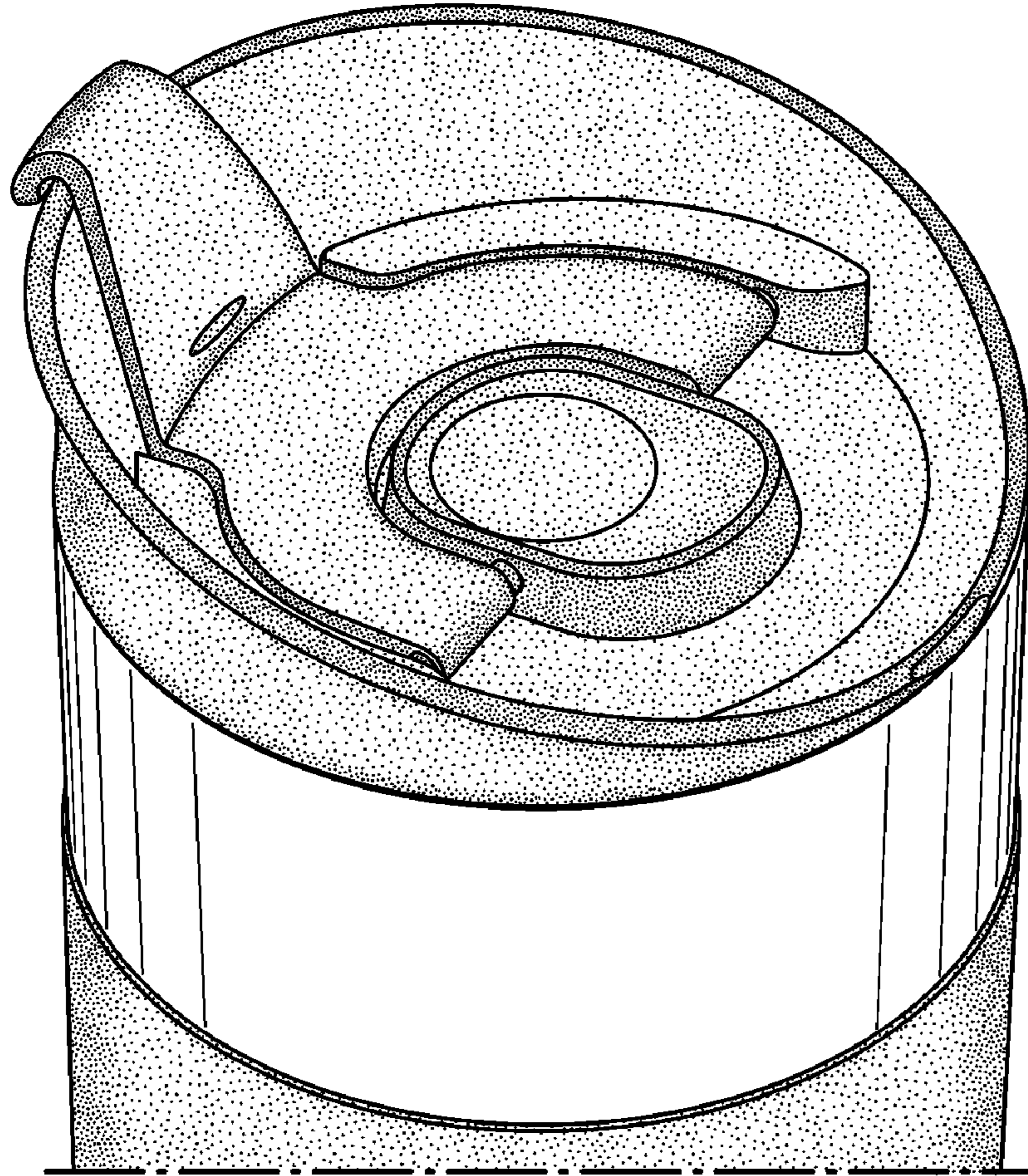

FIG. 9