



US00D622507S

(12) **United States Design Patent**  
**Walter**

(10) **Patent No.:** **US D622,507 S**

(45) **Date of Patent:** **\*\* Aug. 31, 2010**

(54) **BASKET TOP AND HANDLES**

(75) Inventor: **Ivor Michel Walter**, Boulder, CO (US)

(73) Assignee: **AMSA, Inc.**, Boulder, CO (US)

(\*\*) Term: **14 Years**

(21) Appl. No.: **29/356,908**

(22) Filed: **Mar. 4, 2010**

(51) **LOC (9) Cl.** ..... **03-01**

(52) **U.S. Cl.** ..... **D3/307**

(58) **Field of Classification Search** ..... D3/304,  
D3/307-309, 314-315; D8/300, 315, 320;  
206/503-507, 510; 220/752, 755, 676

See application file for complete search history.

(56) **References Cited**

**U.S. PATENT DOCUMENTS**

D276,281 S *	11/1984	Landgren .....	D3/309
D283,457 S *	4/1986	Smith .....	D3/307
D326,552 S *	5/1992	Goodell .....	D3/312
D347,098 S *	5/1994	Hummel et al. ....	D3/309
D364,961 S *	12/1995	Rehrig .....	D3/307
D384,815 S *	10/1997	Rehrig .....	D3/318
D401,065 S *	11/1998	Peltola .....	D3/304
D471,713 S *	3/2003	Speed .....	D3/307
D497,253 S *	10/2004	Alves .....	D3/309

D508,322 S \* 8/2005 Horst ..... D3/315

\* cited by examiner

*Primary Examiner*—Elizabeth A Albert

*Assistant Examiner*—Kelley A Donnelly

(74) *Attorney, Agent, or Firm*—Margaret Polson; Oppedahl Patent Law Firm LLC

(57) **CLAIM**

The ornamental design for a basket top and handles, as shown and described.

**DESCRIPTION**

FIG. 1 is a left side elevation view with the handles raised, the right side being a mirror image;

FIG. 2 is a front elevation view with the handles raised thereof, the back being a mirror image;

FIG. 3 is a top plan view thereof with the handles lowered;

FIG. 4 is a left side elevation view thereof, the right side being a mirror image;

FIG. 5 is a front elevation view thereof, the back being a mirror image; and,

FIG. 6 is a top perspective view thereof with one handle lowered.

The broken lines in the drawings are for the purpose of illustrating environment only and form no part of the claimed design.

**1 Claim, 3 Drawing Sheets**

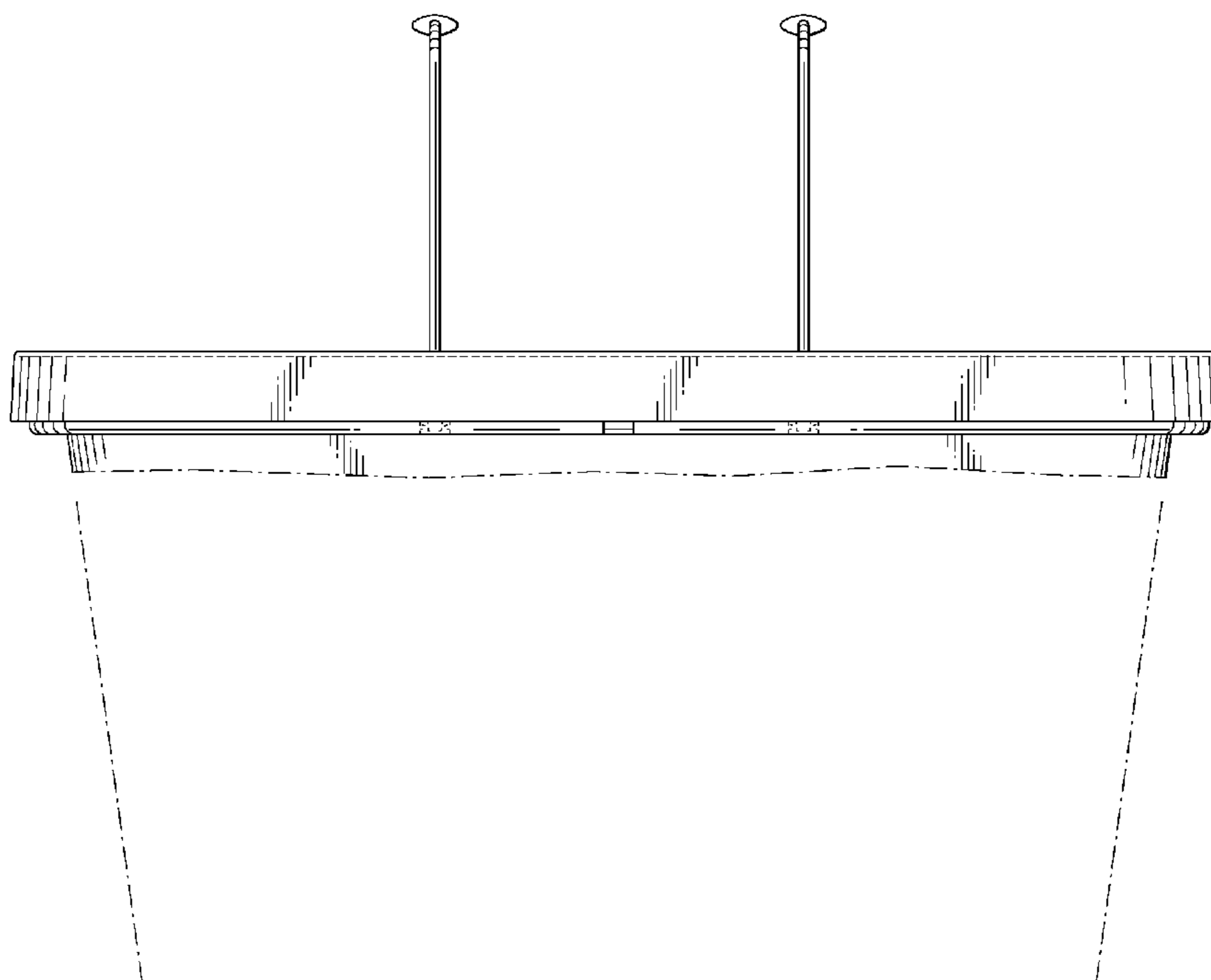

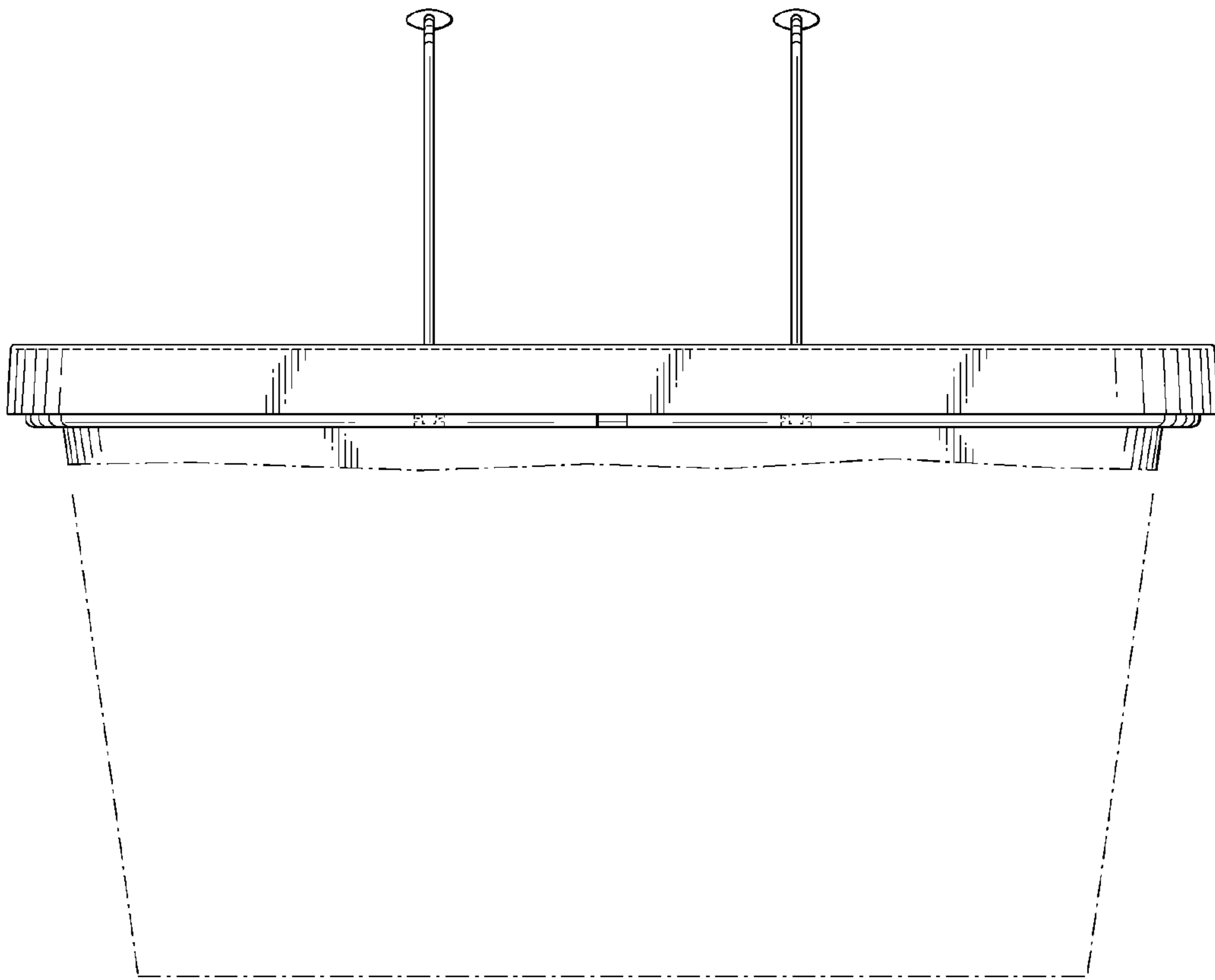

FIG. 1

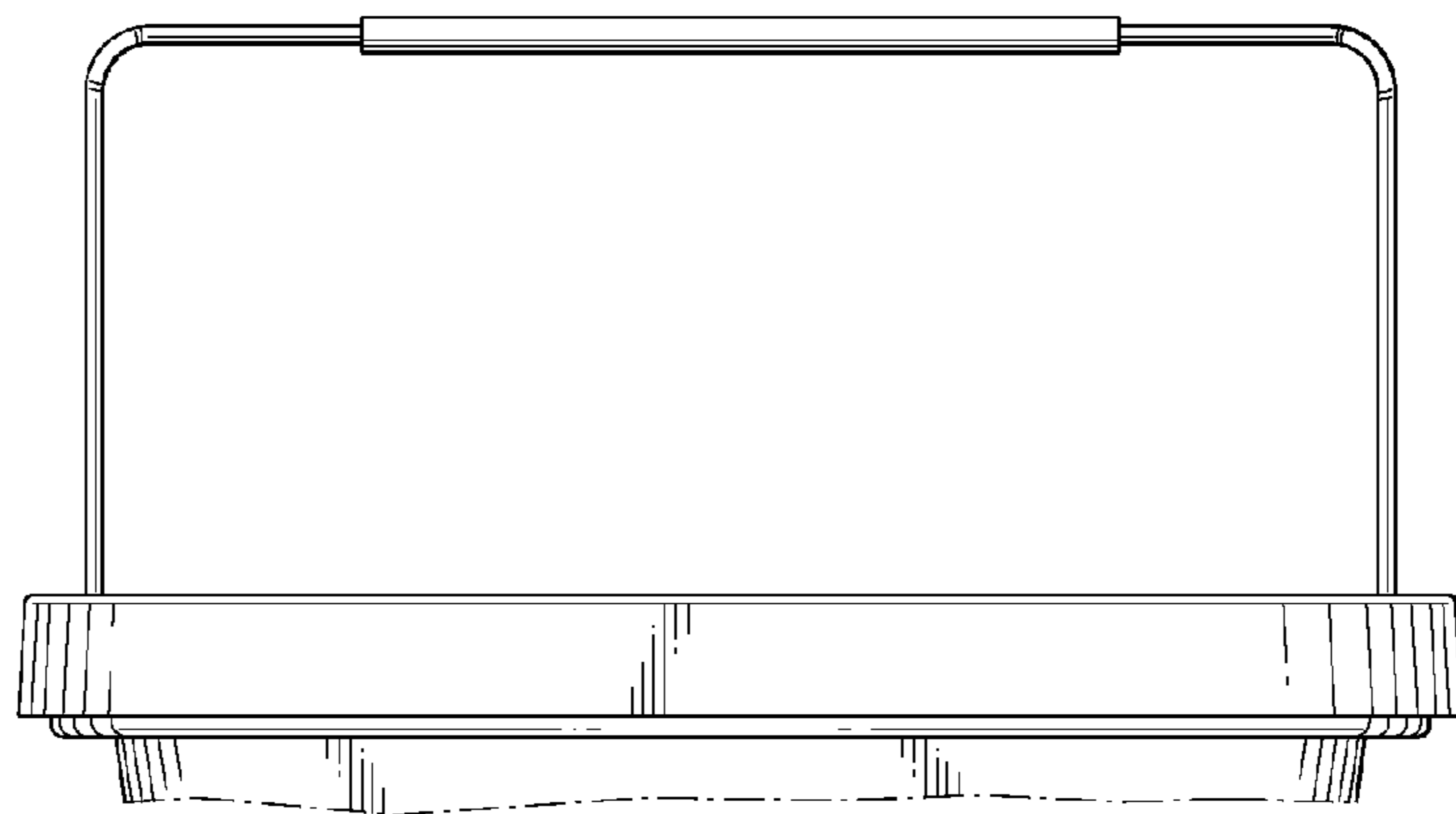

FIG. 2

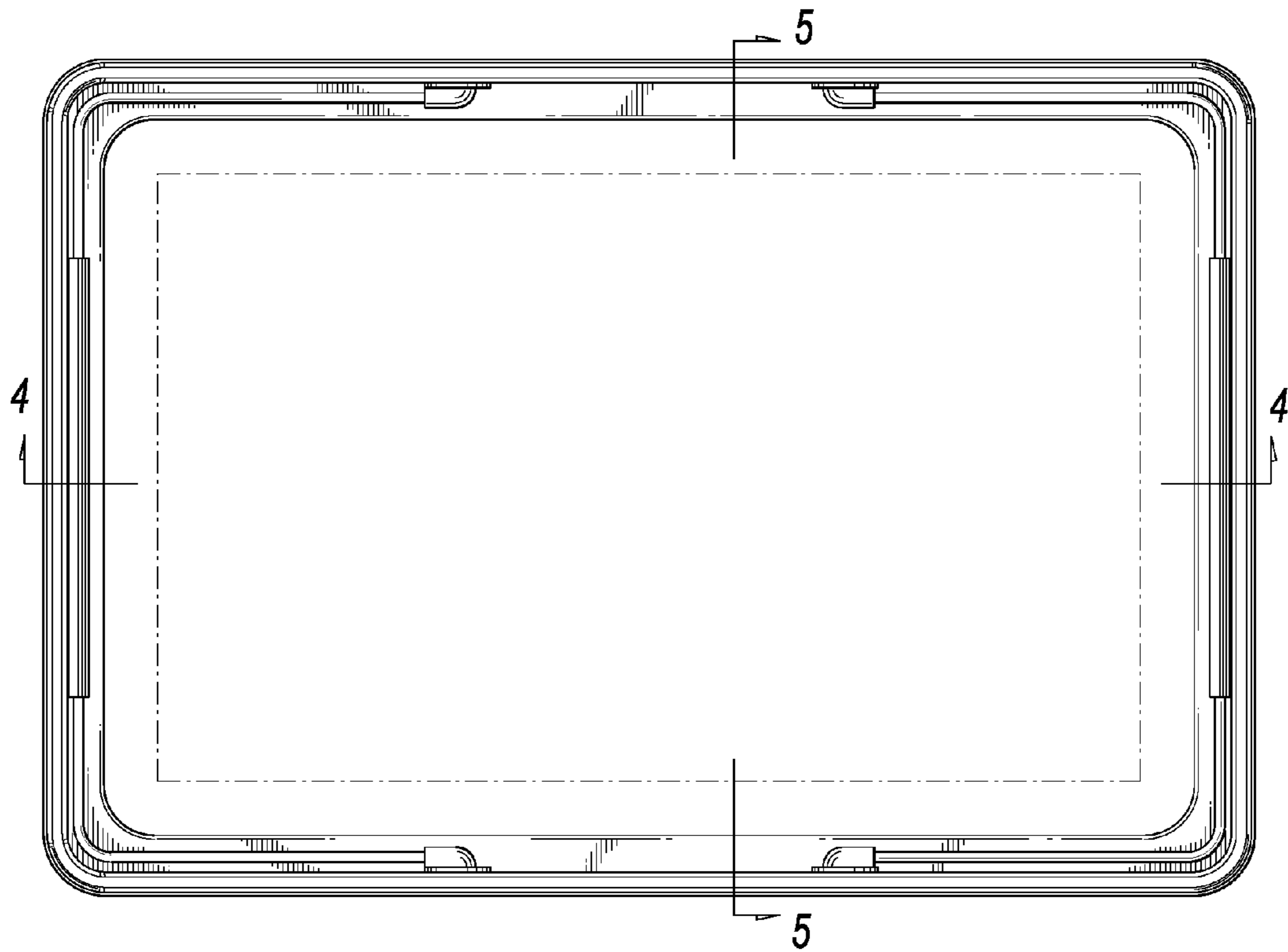

FIG.3

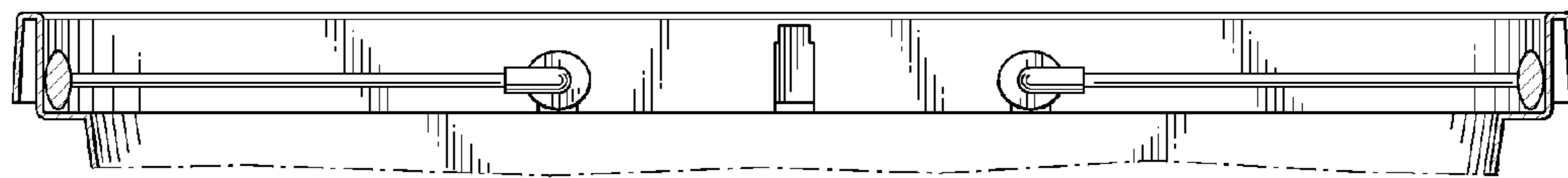

FIG.4

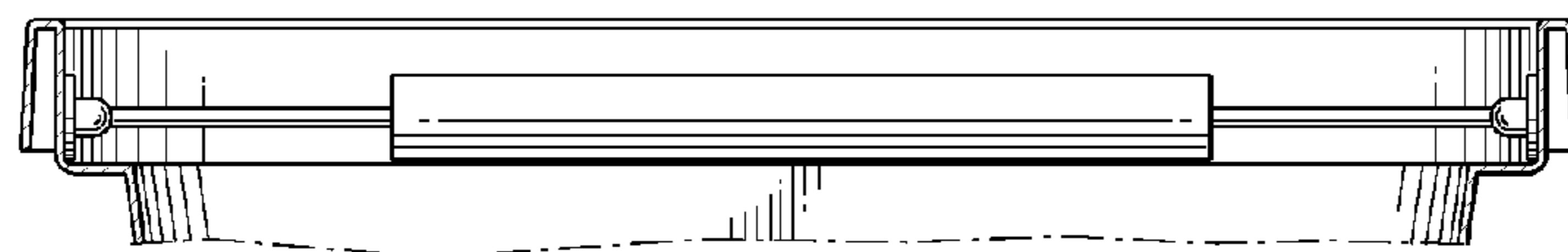

FIG.5

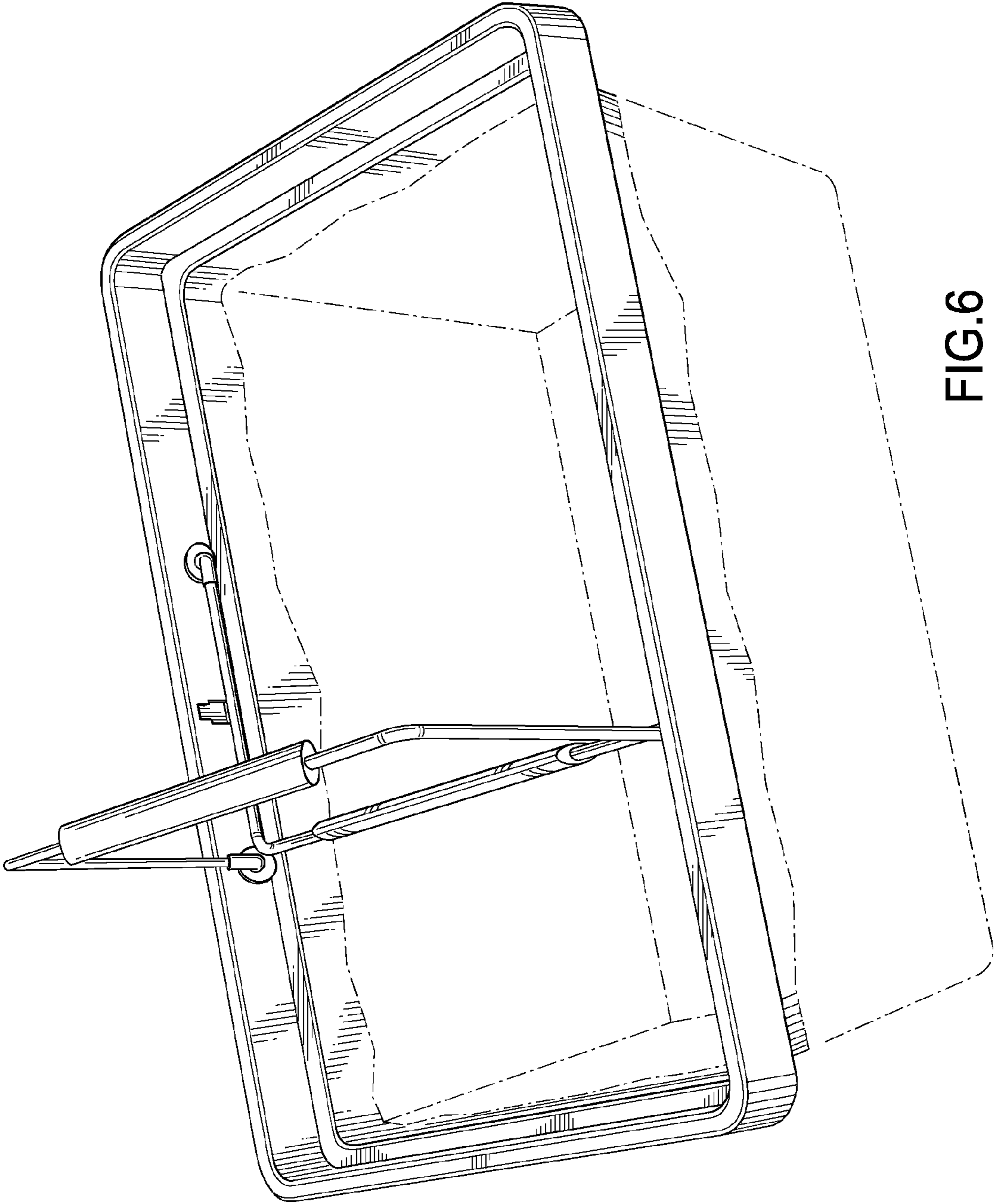

FIG. 6