



US00D622480S

(12) **United States Design Patent**  
**Chionna**

(10) **Patent No.:** **US D622,480 S**  
(45) **Date of Patent:** **\*\* Aug. 31, 2010**

(54) **TROUSERS**

(76) Inventor: **Carlo Chionna**, Via Lemonia, 54, 40133  
Bologna (IT)

(\*\*) Term: **14 Years**

(21) Appl. No.: **29/312,135**

(22) Filed: **Oct. 1, 2008**

(30) **Foreign Application Priority Data**

Apr. 4, 2008 (EM) ..... 000911623

(51) **LOC (9) Cl.** ..... **02-02**

(52) **U.S. Cl.** ..... **D2/742**

(58) **Field of Classification Search** ..... D2/731,  
D2/738, 742; 2/227, 228, 238  
See application file for complete search history.

(56) **References Cited**

**U.S. PATENT DOCUMENTS**

D31,772 S *	10/1899	Scriven	.....	D2/712
4,156,294 A *	5/1979	Horn	.....	2/400
D532,958 S *	12/2006	Kent	.....	D2/742
D535,084 S *	1/2007	Kelty	.....	D2/742
D537,237 S *	2/2007	Chionna	.....	D2/742
D571,533 S *	6/2008	Wiens	.....	D2/713
7,500,274 B1 *	3/2009	Kallen	.....	2/227
2006/0230488 A1 *	10/2006	Rudolph	.....	2/69
2009/0025115 A1 *	1/2009	Duffy et al.	.....	2/69

2009/0038046 A1\* 2/2009 Moore et al. .... 2/67

**FOREIGN PATENT DOCUMENTS**

EP	1502513	A1 *	2/2005
JP	09021006	A *	1/1997
JP	2000045108	A *	2/2000
JP	2006219778	A *	8/2006

\* cited by examiner

*Primary Examiner*—Ian Simmons

*Assistant Examiner*—Rashida Johnson

(74) *Attorney, Agent, or Firm*—Fay Sharpe LLP

(57) **CLAIM**

The ornamental design for trousers, as shown and described.

**DESCRIPTION**

FIG. 1 is a front perspective view of trousers showing my new design,

FIG. 2 is a front view,

FIG. 3 is a right side view,

FIG. 4 is a rear view,

FIG. 5 is a left side view,

FIG. 6 is a top view; and,

FIG. 7 is a bottom view.

The broken lines shown throughout the views represent stitching.

**1 Claim, 5 Drawing Sheets**

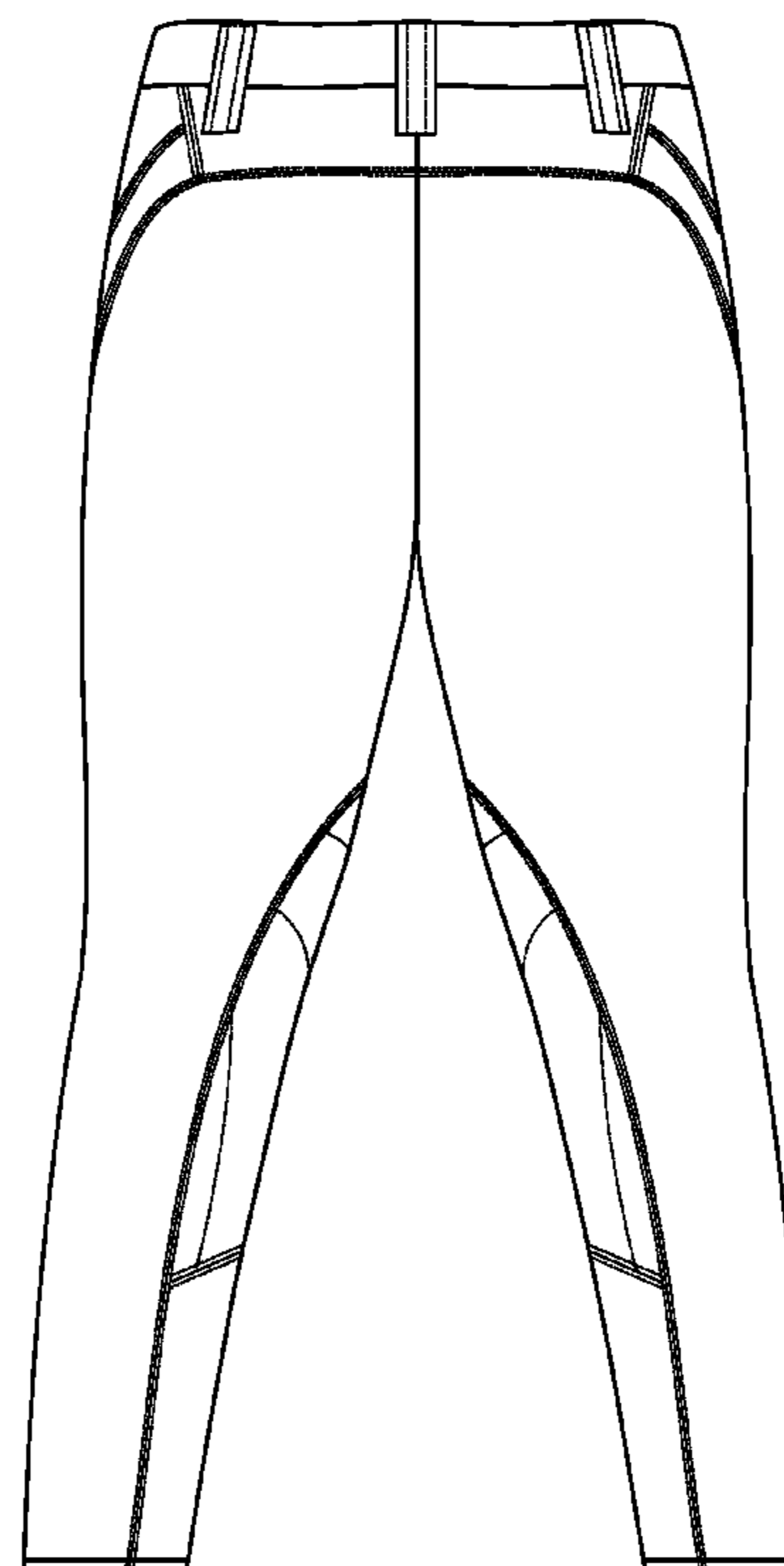
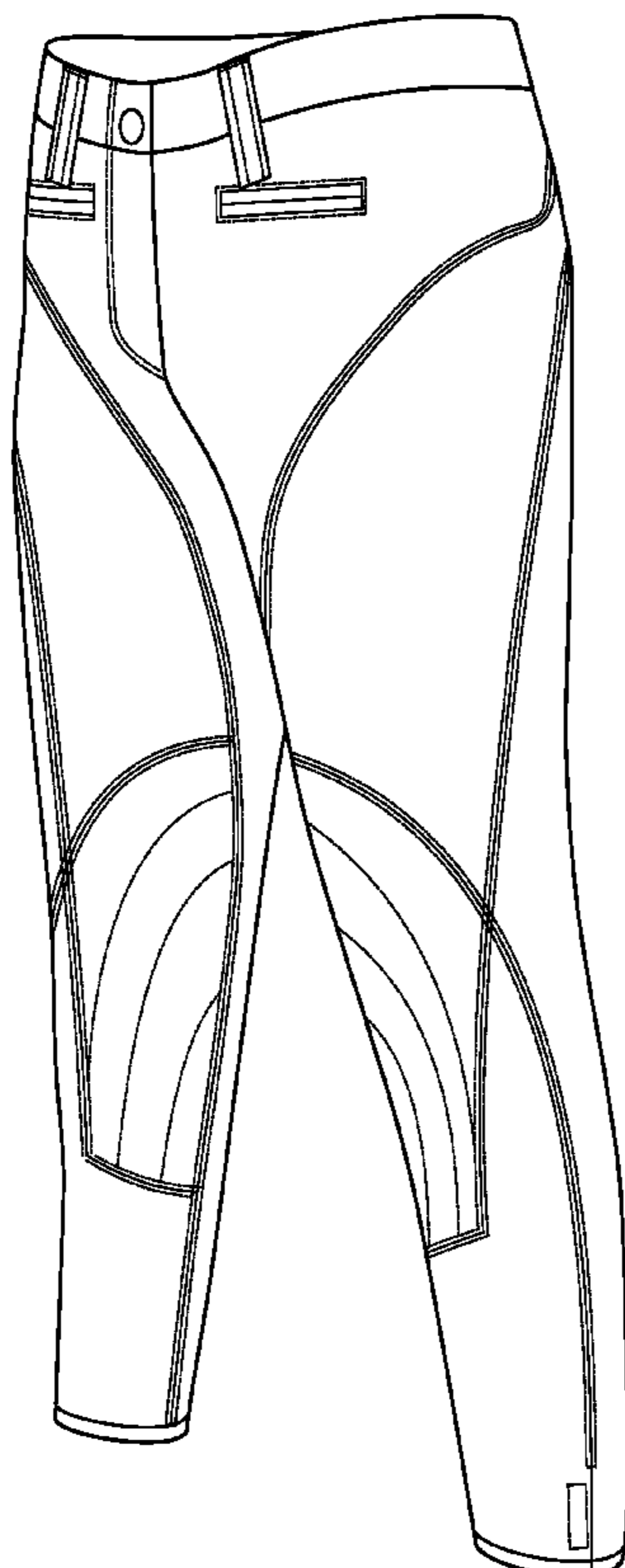

*FIG. 1*

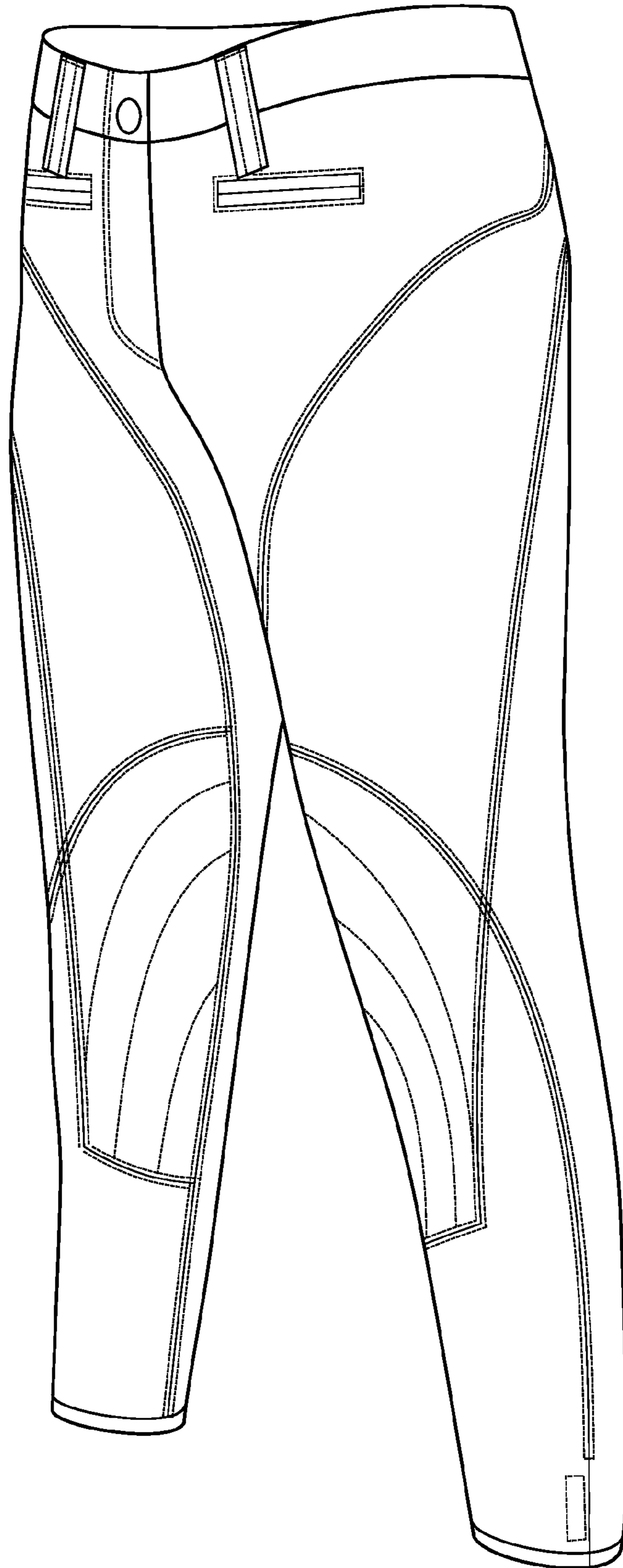

FIG. 2

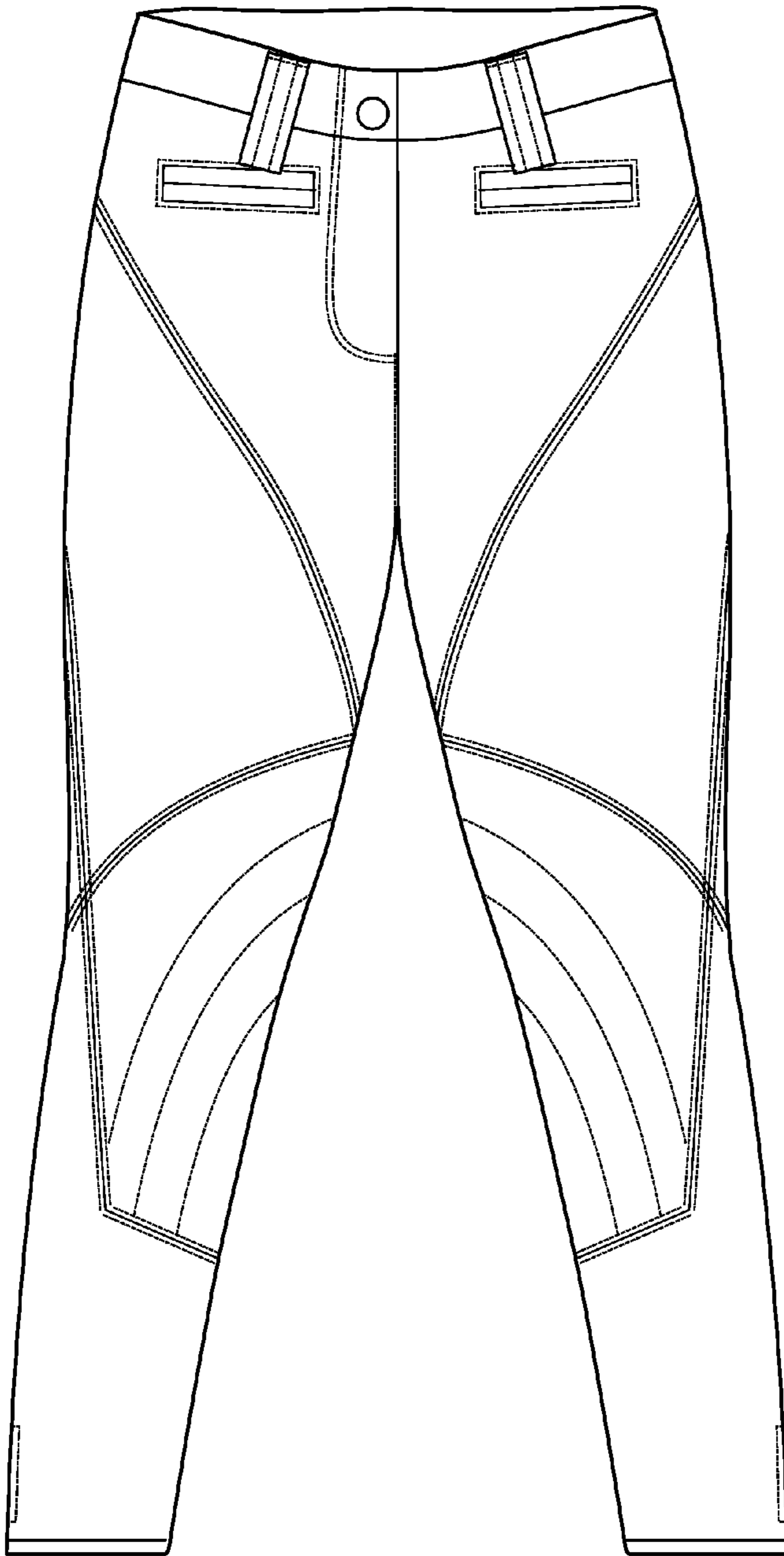
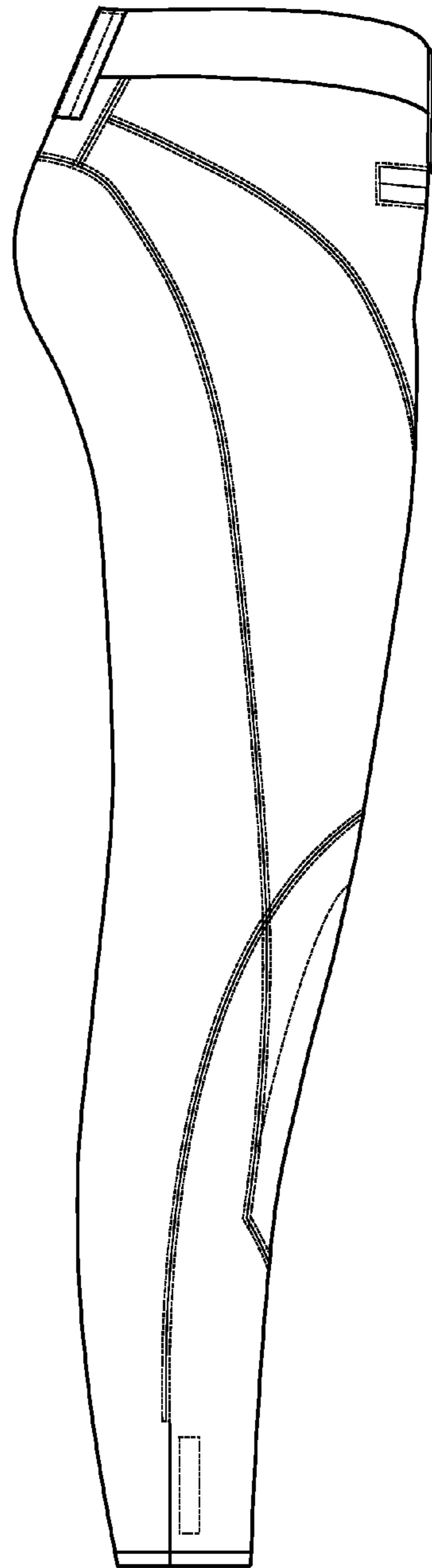

FIG. 3



*FIG.4*

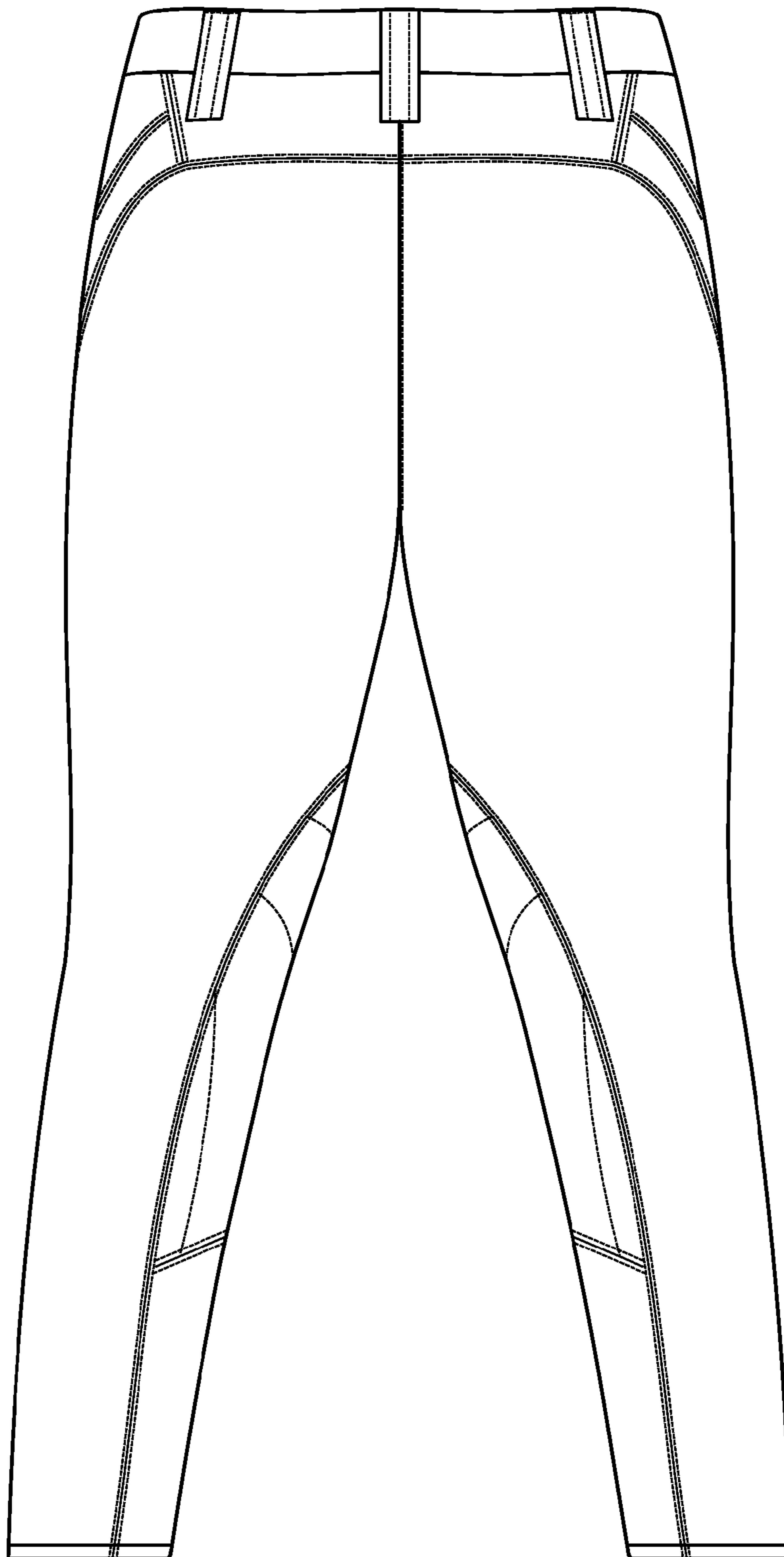
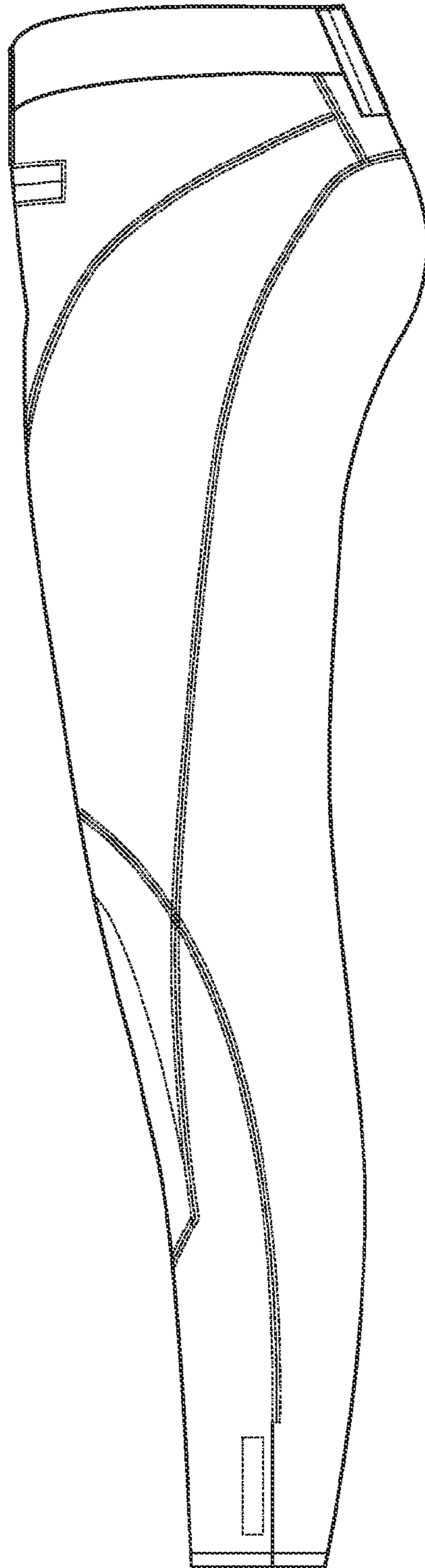
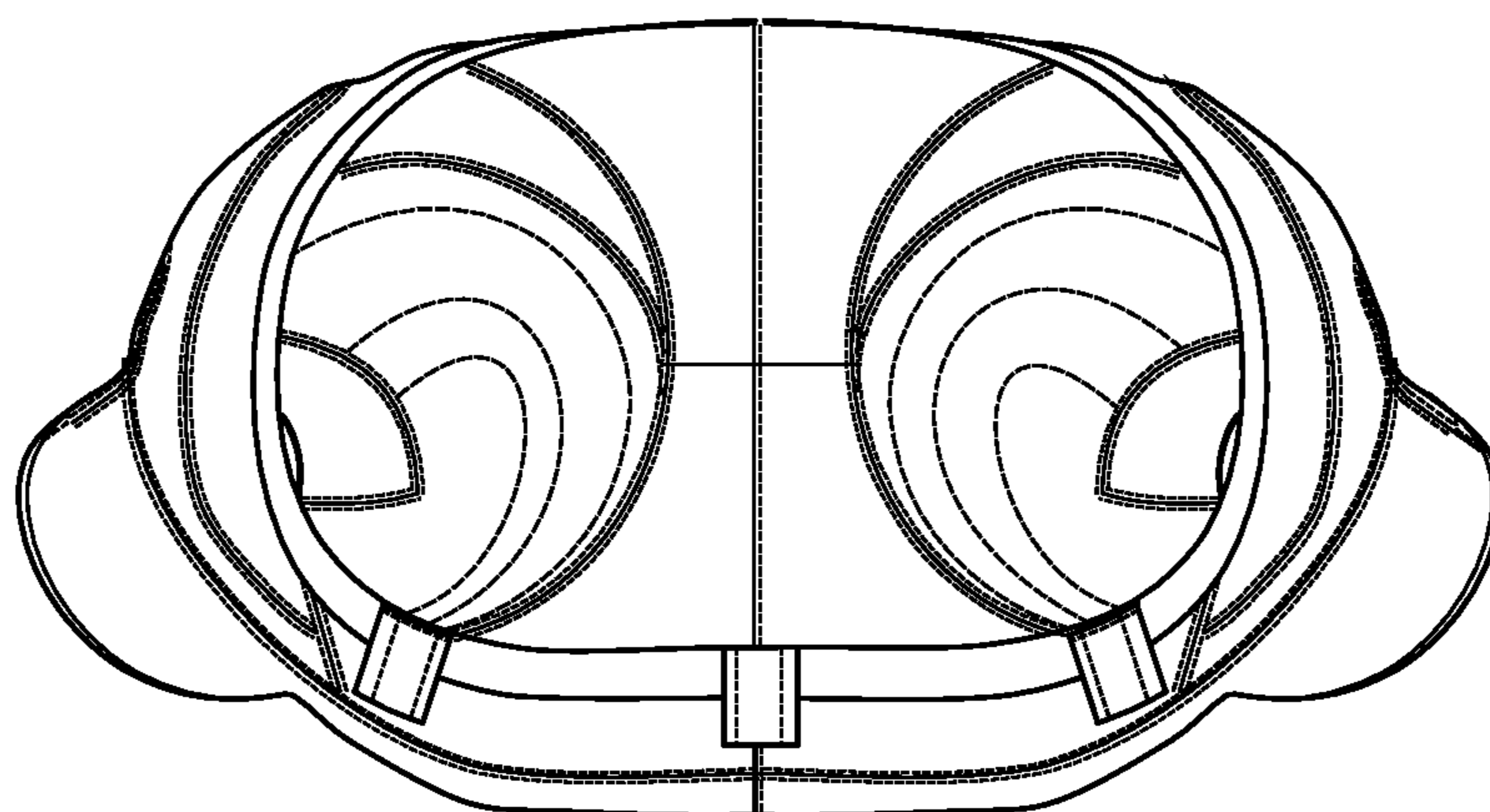

FIG. 5



*FIG. 6*



*FIG. 7*

