



US00D622404S

(12) **United States Design Patent**
Williams

(10) **Patent No.:** **US D622,404 S**

(45) **Date of Patent:** **** Aug. 24, 2010**

(54) **WOUND BANDAGE**

(76) Inventor: **Halsted S. Williams**, 3921 Allan Pl.,
Sarasota, FL (US) 34241

(**) Term: **14 Years**

(21) Appl. No.: **29/357,772**

(22) Filed: **Mar. 17, 2010**

(51) **LOC (9) Cl.** **24-04**

(52) **U.S. Cl.** **D24/189**

(58) **Field of Classification Search** D24/189,
D24/134, 135, 128; D20/11, 23, 24, 26,
D20/36; 602/41-43; 604/174, 18; 40/359,
40/360, 638

See application file for complete search history.

(56) **References Cited**

U.S. PATENT DOCUMENTS

3,425,412	A *	2/1969	Pope	602/59
D294,650	S *	3/1988	De Beys	D2/706
5,354,261	A *	10/1994	Clark et al.	602/58
D376,850	S *	12/1996	Dunshee et al.	D24/189
D377,688	S *	1/1997	Dunshee et al.	D24/189
5,702,356	A *	12/1997	Hathman	602/41
D484,985	S *	1/2004	Takizawa et al.	D24/206
D511,573	S *	11/2005	Mueller et al.	D24/189
D562,461	S *	2/2008	Nash	D24/189
D580,553	S *	11/2008	Nash	D24/189
D601,707	S *	10/2009	Chouiller	D24/189

* cited by examiner

Primary Examiner—Holly H Baynham

Assistant Examiner—Michelle E Wilson

(74) *Attorney, Agent, or Firm*—Charles J. Prescott

(57) **CLAIM**

The ornamental design for a wound bandage, as shown and described.

DESCRIPTION

FIG. 1 is a perspective view of one embodiment of a wound bandage showing my new design;

FIG. 2 is a lower perspective view of FIG. 1;

FIG. 3 is a top plan view of FIG. 1;

FIG. 4 is a bottom plan view of FIG. 1;

FIG. 5 is a front elevation view of FIG. 1;

FIG. 6 is a rear elevation view of FIG. 1;

FIG. 7 is a right side elevation view of FIG. 1;

FIG. 8 is a left side view of FIG. 1;

FIG. 9 is a perspective view of another embodiment of a wound bandage showing my new design;

FIG. 10 is a lower perspective view of FIG. 9;

FIG. 11 is a top plan view of FIG. 9;

FIG. 12 is a bottom plan view of FIG. 9;

FIG. 13 is a front elevation view of FIG. 9, the rear elevation view being a mirror image thereof; and,

FIG. 14 is a right side elevation view of FIG. 9, the left side elevation view being a mirror image thereof.

1 Claim, 6 Drawing Sheets

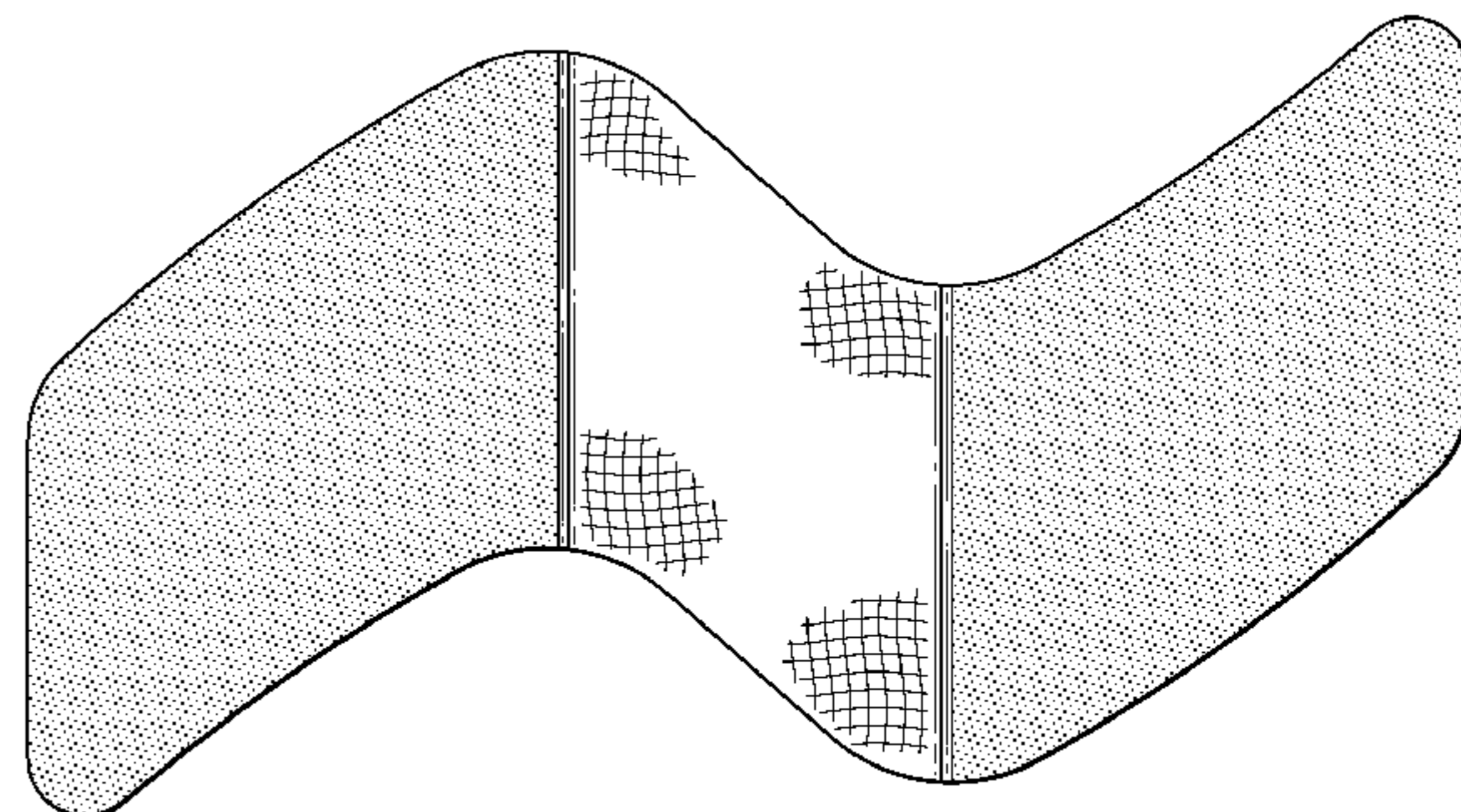
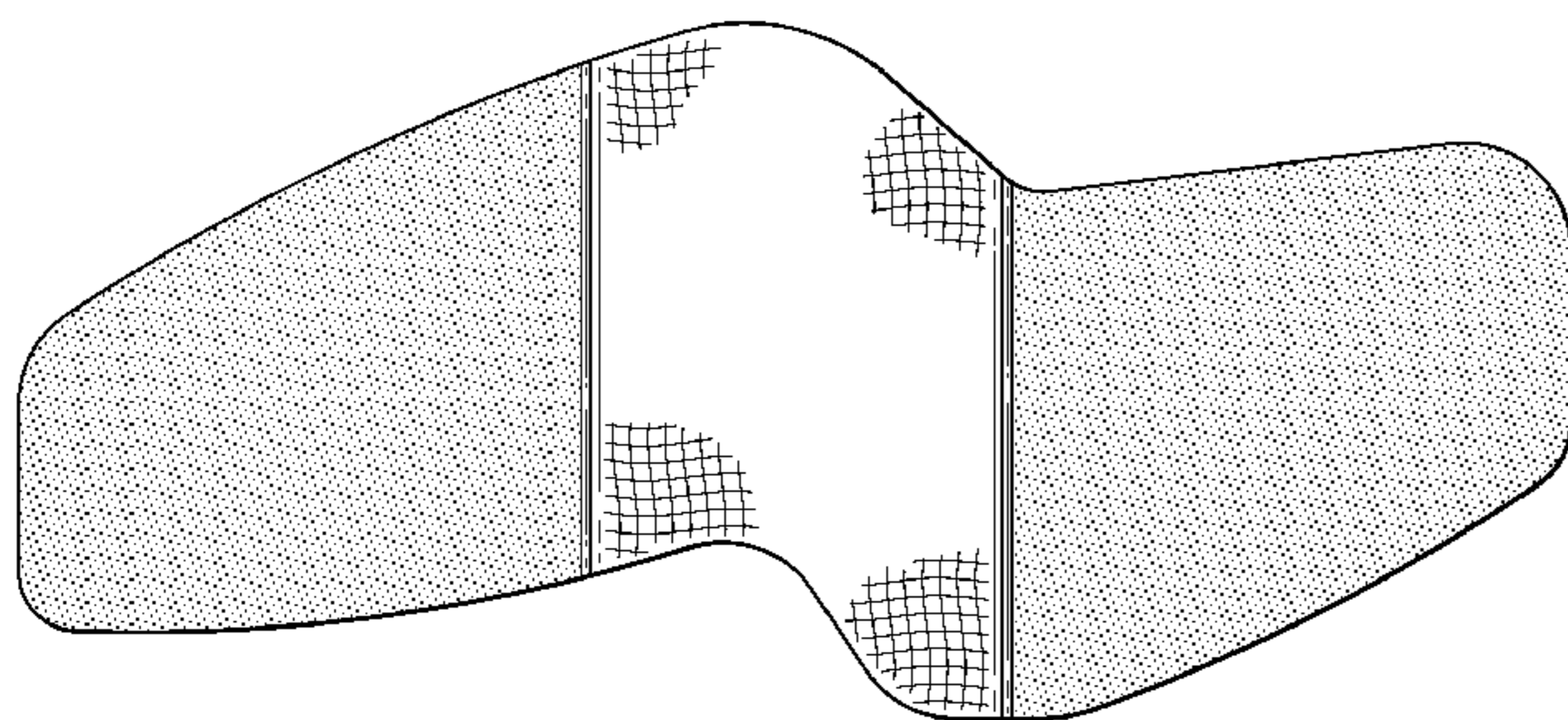

FIG. 1

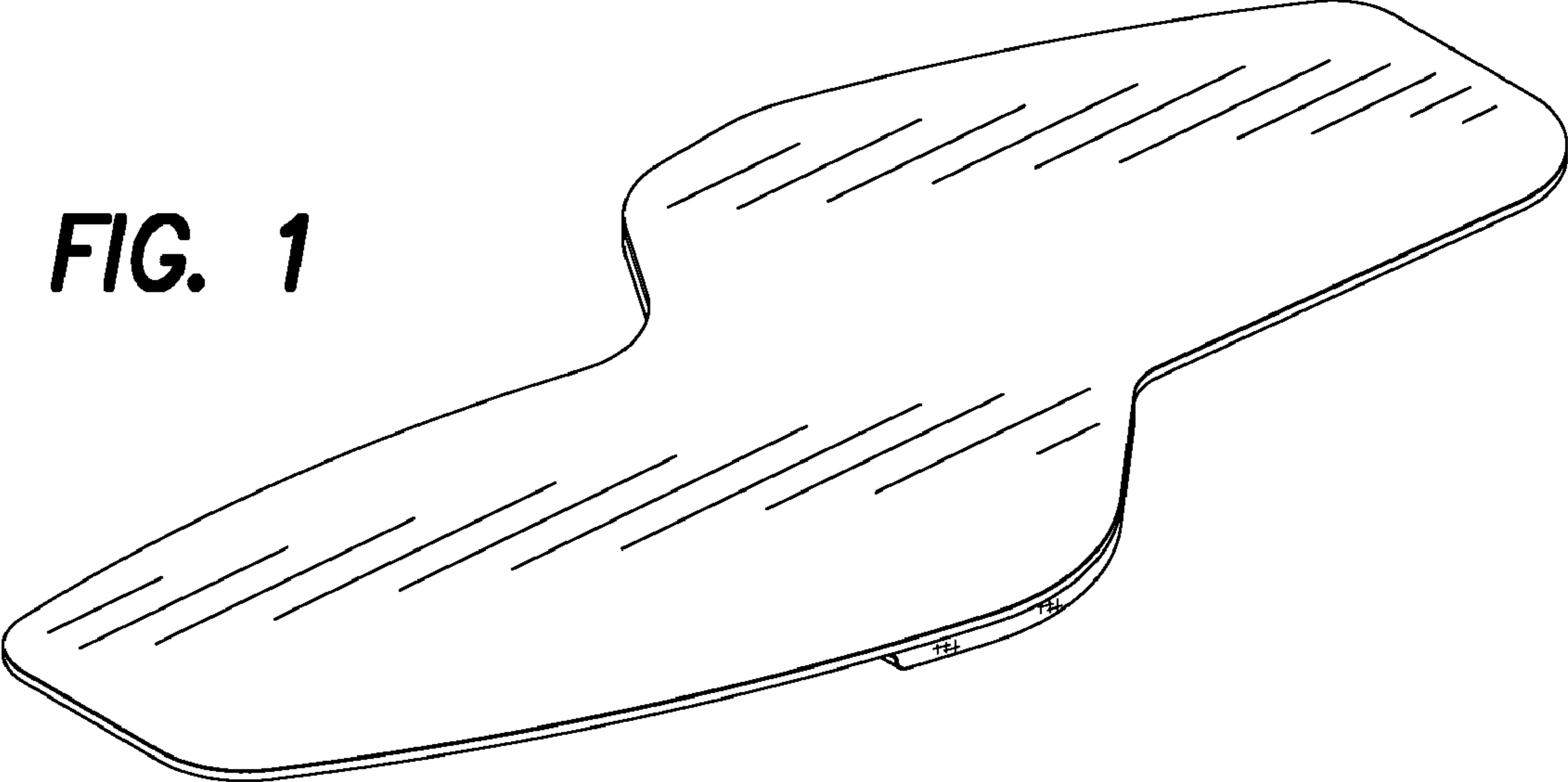

FIG. 2

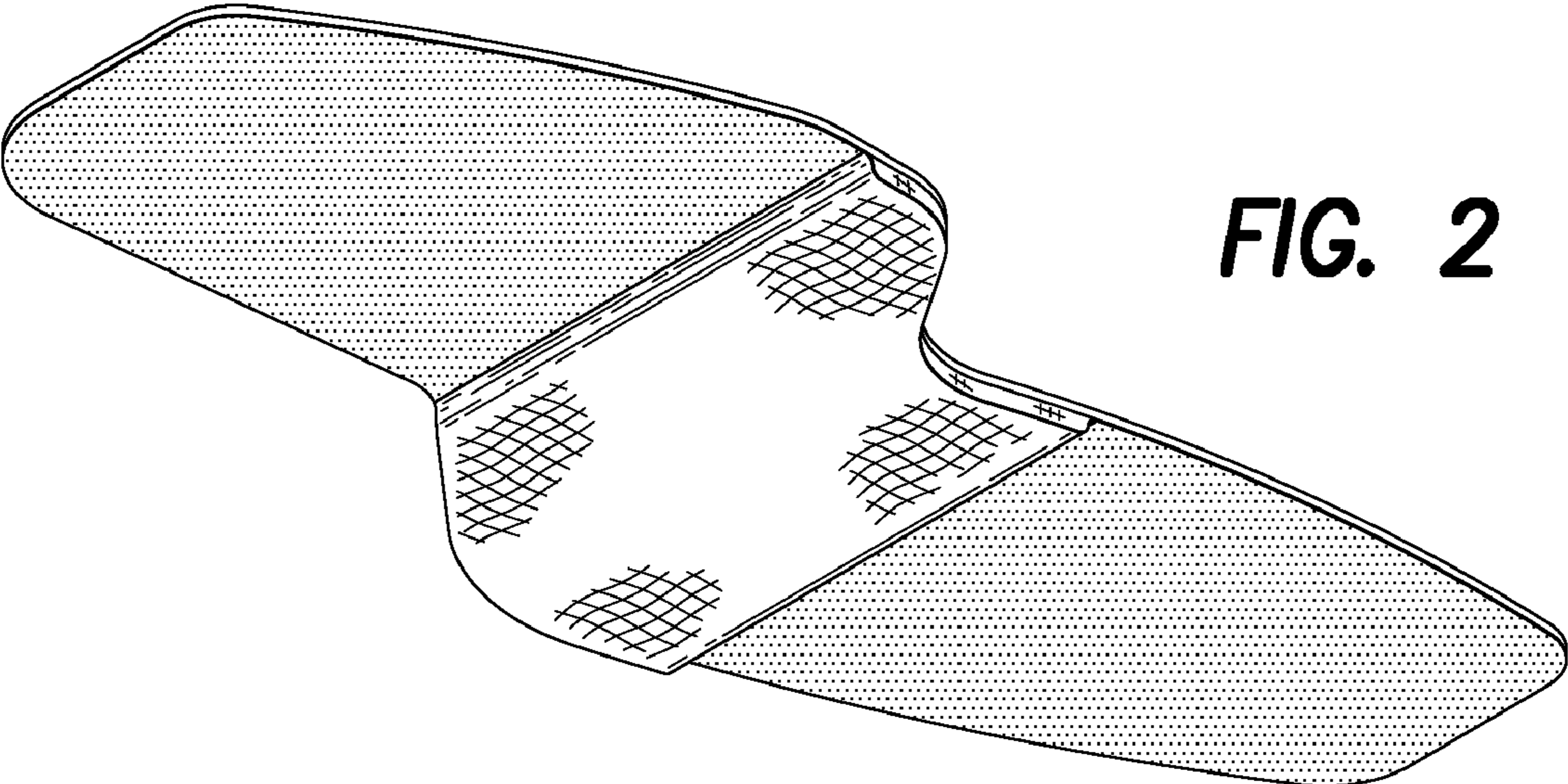

FIG. 3

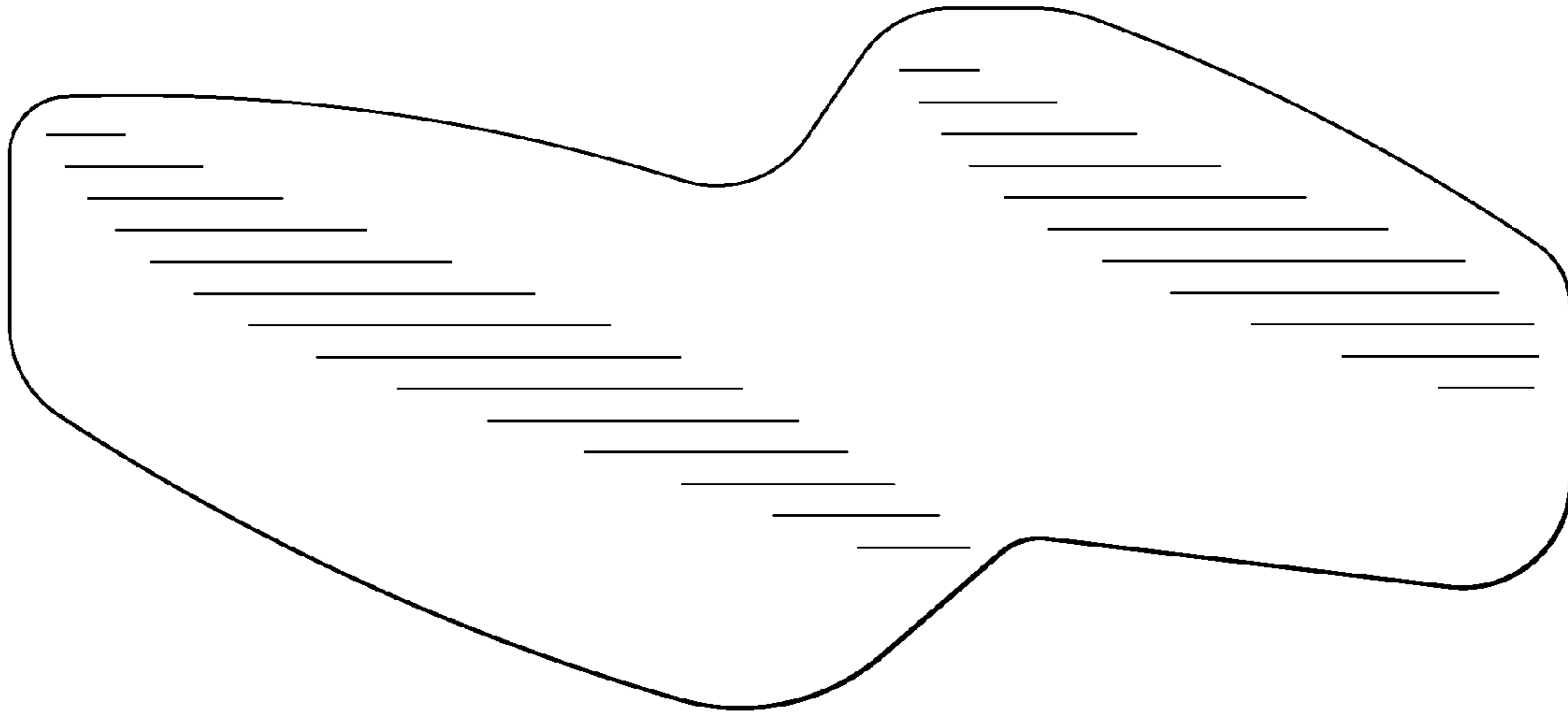

FIG. 4

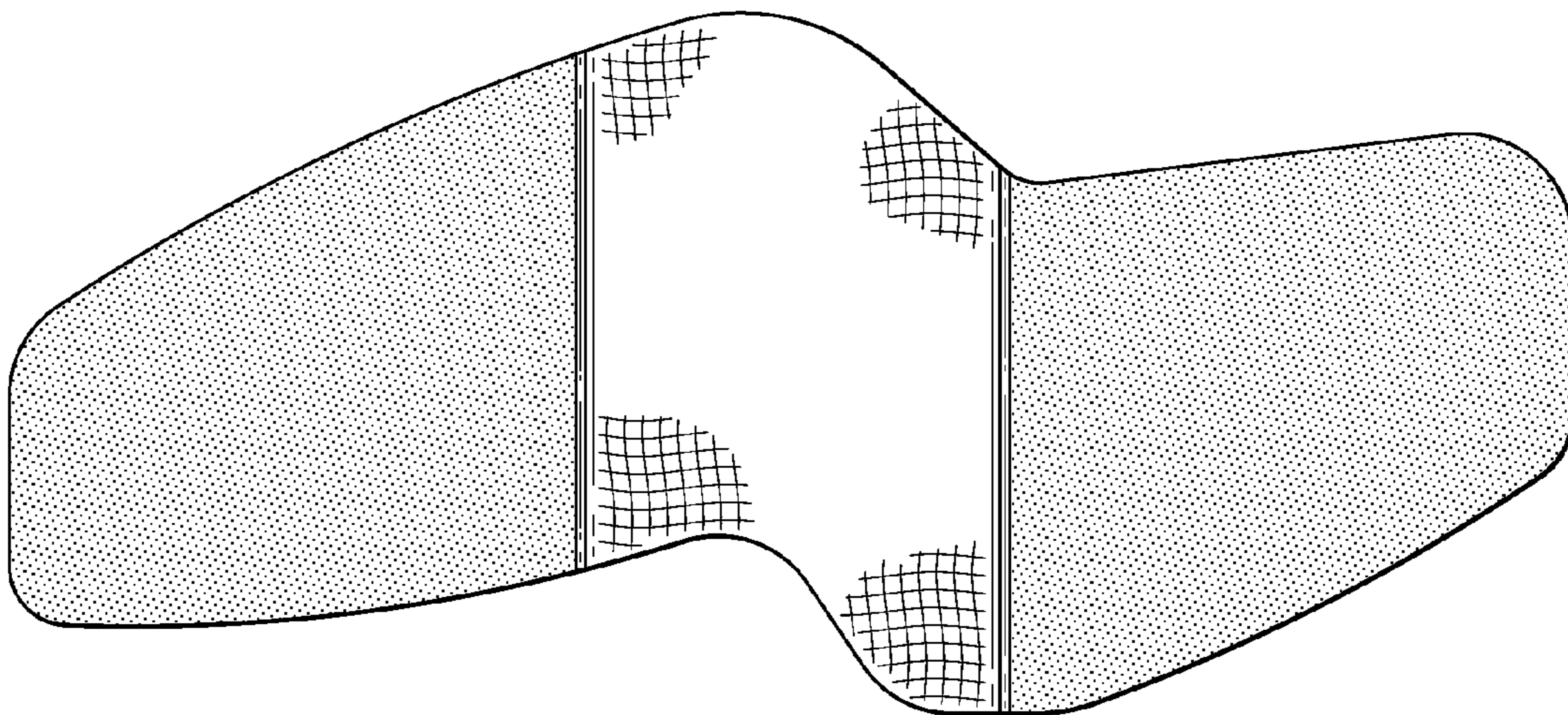

FIG. 5

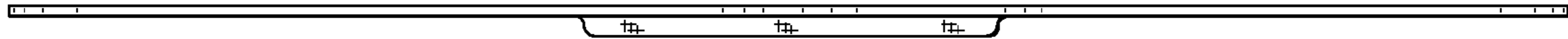

FIG. 6

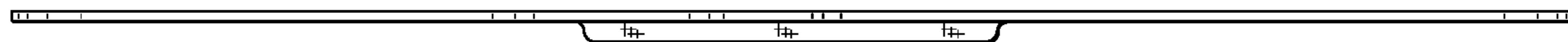

FIG. 7

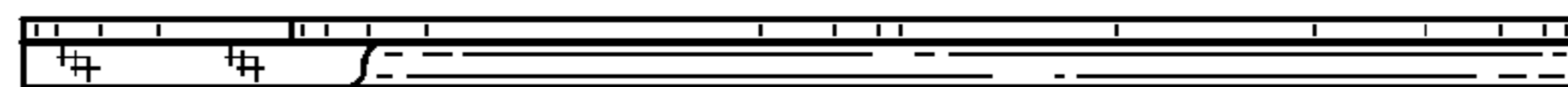

FIG. 8

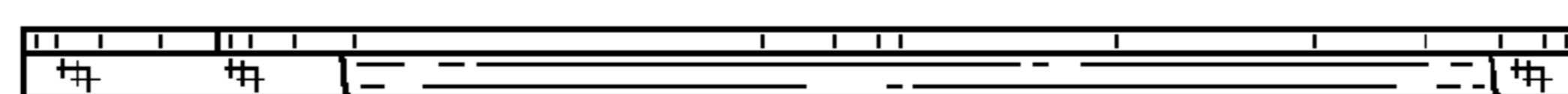

FIG. 9

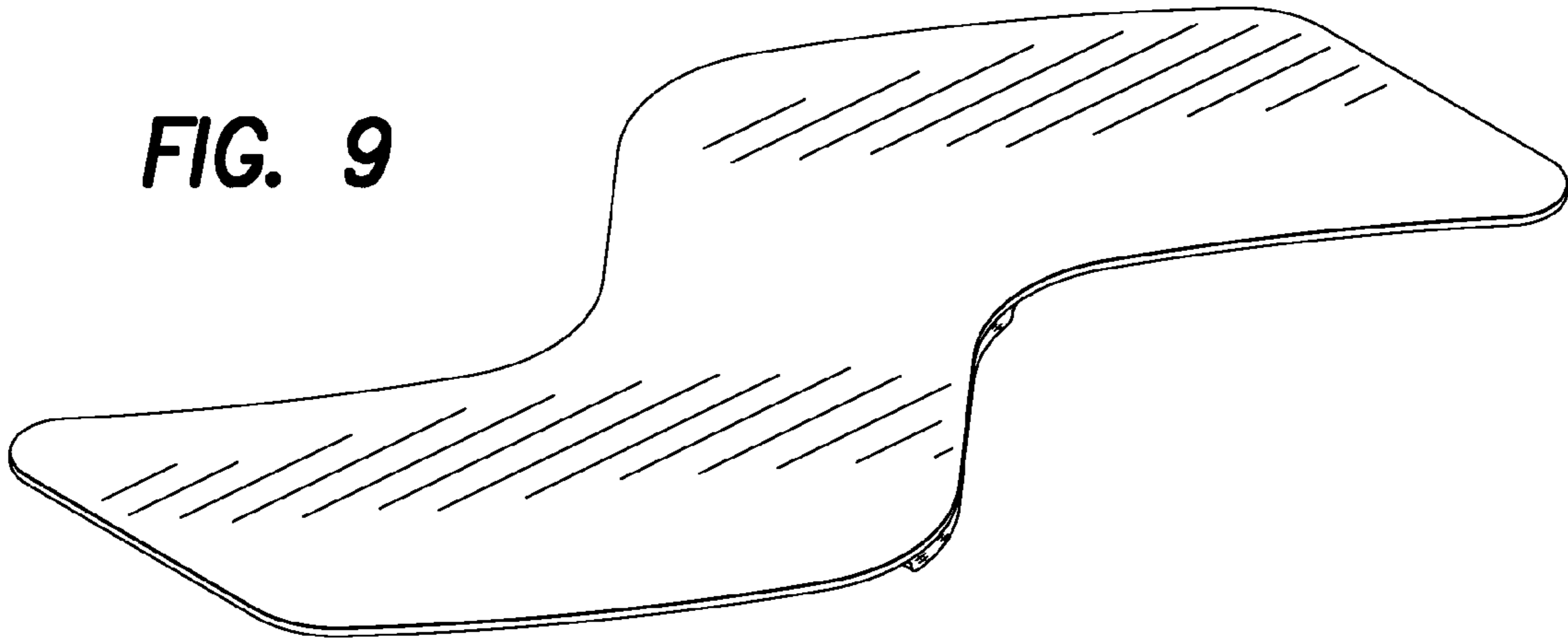

FIG. 10

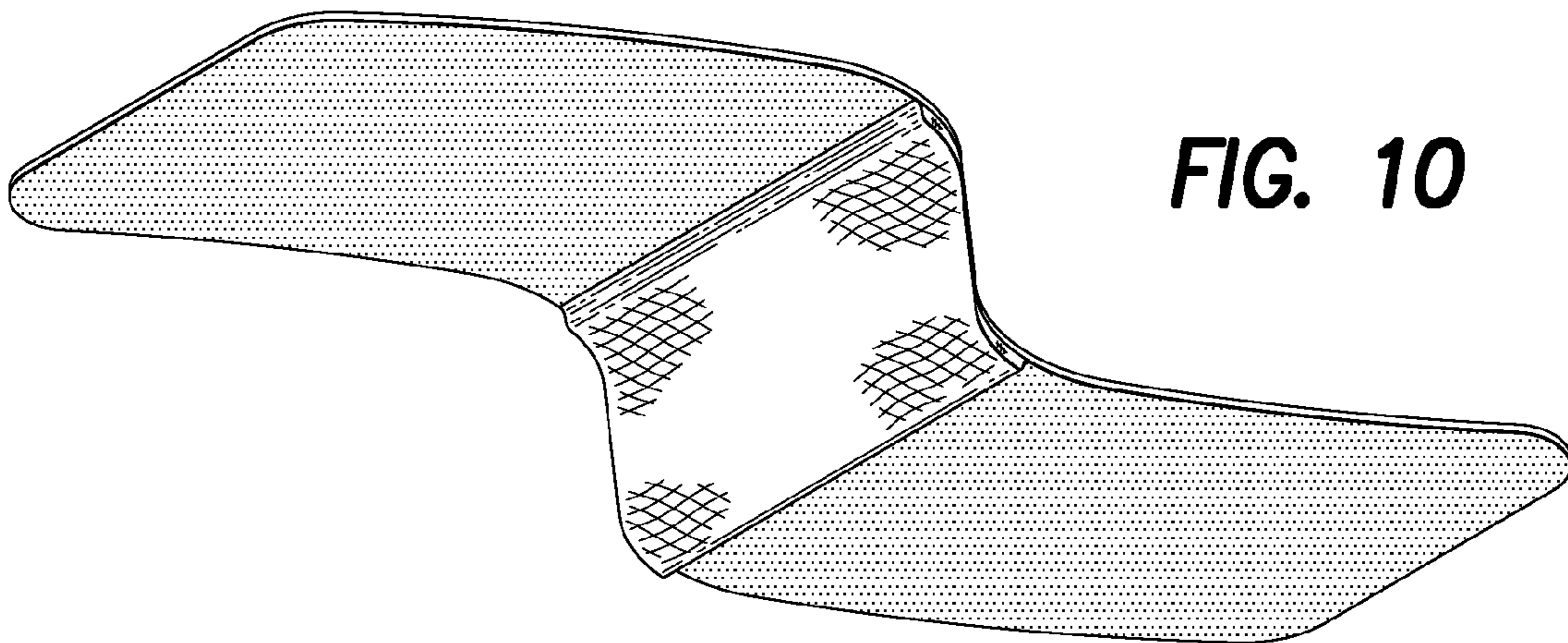

FIG. 11

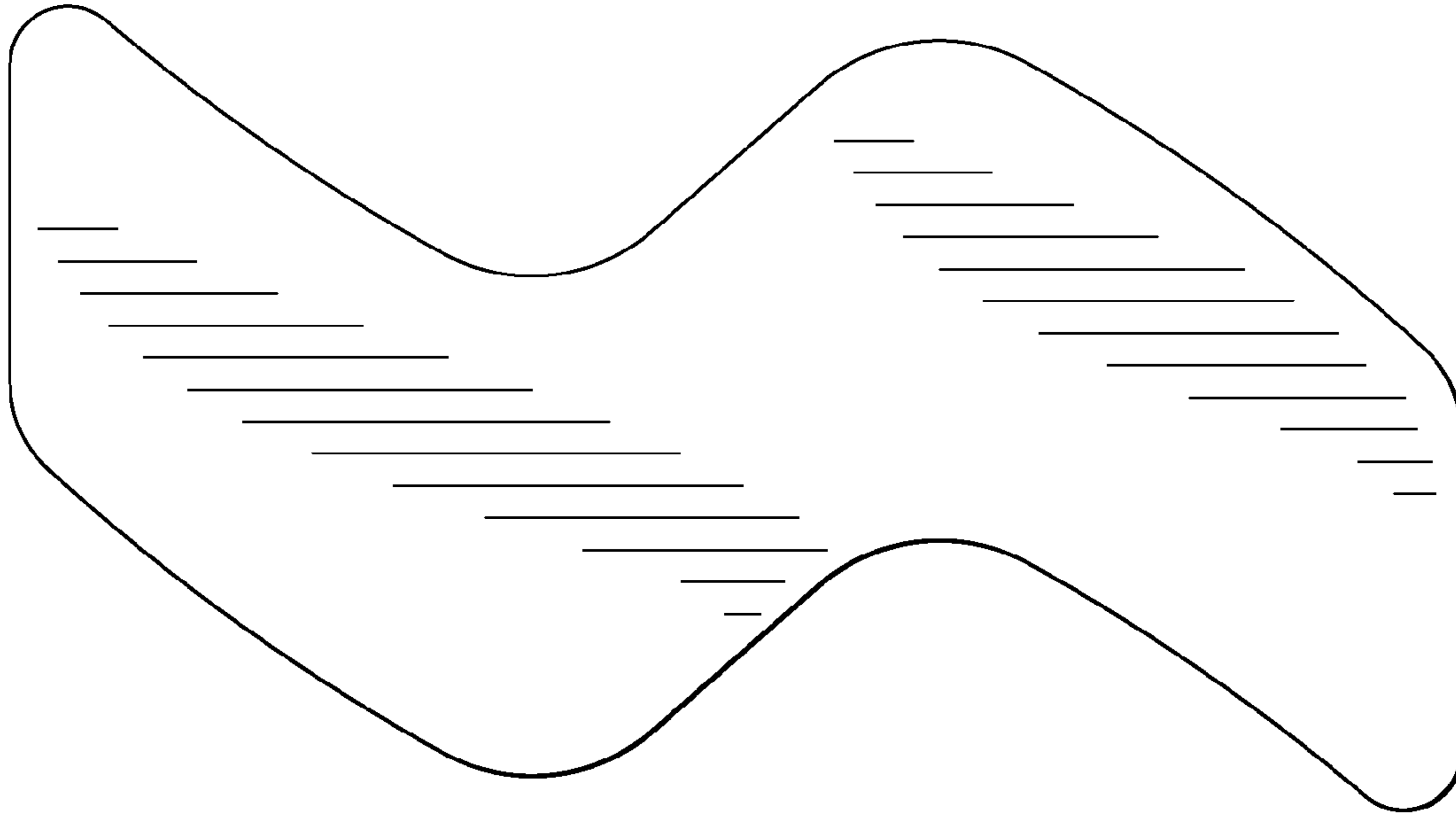

FIG. 12

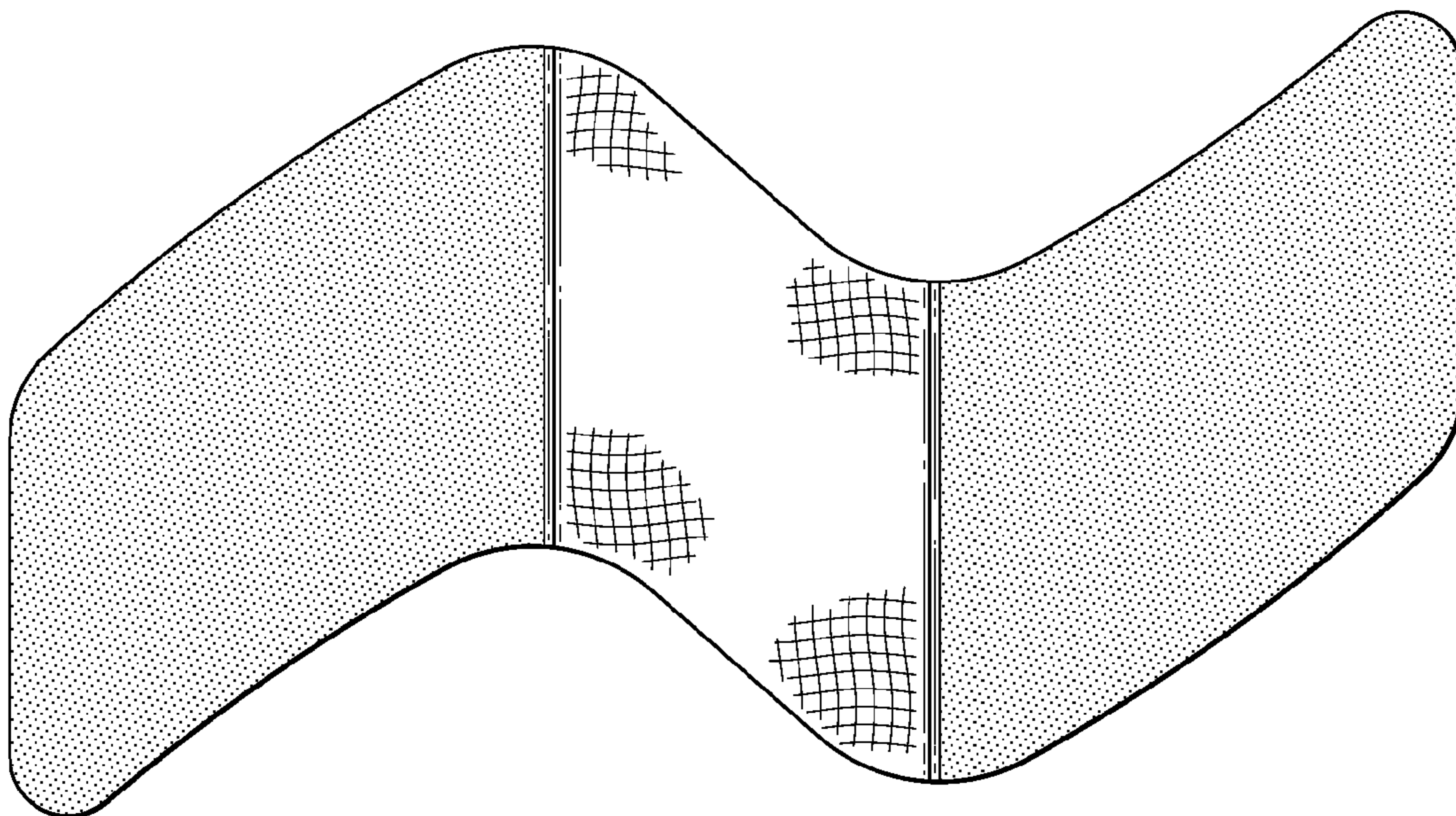

FIG. 13

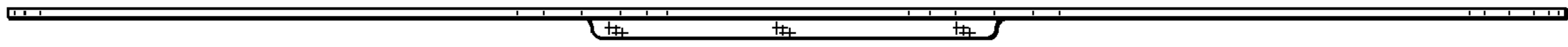

FIG. 14

