



US00D622384S

(12) **United States Design Patent**
Fisher et al.

(10) **Patent No.:** **US D622,384 S**

(45) **Date of Patent:** **** Aug. 24, 2010**

(54) **SURGICAL SAW DEVICE**

(57) **CLAIM**

(75) Inventors: **Michael G. Fisher**, Folsom, CA (US);
John Anes, Folsom, CA (US)

The ornamental design for a surgical saw device, as shown and described.

(73) Assignee: **Synvasive Technology, Inc.**, El Dorado Hills, CA (US)

DESCRIPTION

(**) Term: **14 Years**

FIG. 1 is a perspective view of a surgical saw device showing our new design;

(21) Appl. No.: **29/340,590**

FIG. 2 is a right side elevational view thereof, the opposite side elevational view being identical thereto;

(22) Filed: **Jul. 21, 2009**

FIG. 3 is a top plan view thereof;

(51) **LOC (9) Cl.** **24-02**

FIG. 4 is a bottom plan view thereof;

(52) **U.S. Cl.** **D24/146**

FIG. 5 is a rear elevational view thereof;

(58) **Field of Classification Search** D8/20,
D8/26, 64; D24/146, 147; 30/151, 162,
30/163, 166.3, 335; 606/82, 85, 176-179
See application file for complete search history.

FIG. 6 is a front elevational view thereof;

(56) **References Cited**

FIG. 7 is a second embodiment of FIG. 3, the only difference being the configuration of the boss, it being understood that all other surfaces are the same;

U.S. PATENT DOCUMENTS

FIG. 8 is a third embodiment of FIG. 3, the only difference being the configuration of the boss, it being understood that all other surfaces are the same;

D3,994 S *	4/1870	Moore	D8/20
D4,255 S *	7/1870	Rhodes	D8/20
D4,497 S *	11/1870	Rhodes	D8/20
D4,706 S *	3/1871	Kidd	D8/20
D5,226 S *	8/1871	Miller	D8/20
3,016,932 A *	1/1962	Jacobson	30/369
4,934,056 A *	6/1990	Leini	30/369
5,306,285 A *	4/1994	Miller et al.	606/177
5,681,314 A *	10/1997	Derouin et al.	606/79
6,857,192 B1 *	2/2005	Summers et al.	30/294
7,060,072 B2 *	6/2006	Wolff et al.	606/84
D525,707 S *	7/2006	Kullmer et al.	D24/146
D552,239 S *	10/2007	Wolff	D24/147
D576,729 S *	9/2008	Tanaka et al.	D24/144
D586,633 S *	2/2009	Taylor et al.	D8/20

FIG. 9 is a fourth embodiment of FIG. 3, the only difference being the configuration of the boss, it being understood that all other surfaces are the same;

FIG. 10 is a fifth embodiment of FIG. 3, the only difference being the configuration of the boss, it being understood that all other surfaces are the same;

FIG. 11 is a sixth embodiment of FIG. 3, the only difference being the configuration of the boss, it being understood that all other surfaces are the same;

FIG. 12 is a seventh embodiment of FIG. 3, the only difference being the configuration of the boss, it being understood that all other surfaces are the same;

FIG. 13 is an eighth embodiment of FIG. 3, the only difference being the configuration of the boss, it being understood that all other surfaces are the same; and,

FIG. 14 is a ninth embodiment of FIG. 3, the only difference being the configuration of the boss, it being understood that all other surfaces are the same.

* cited by examiner

Primary Examiner—Freda S Nunn

(74) *Attorney, Agent, or Firm*—Ladas & Parry, LLP

1 Claim, 2 Drawing Sheets

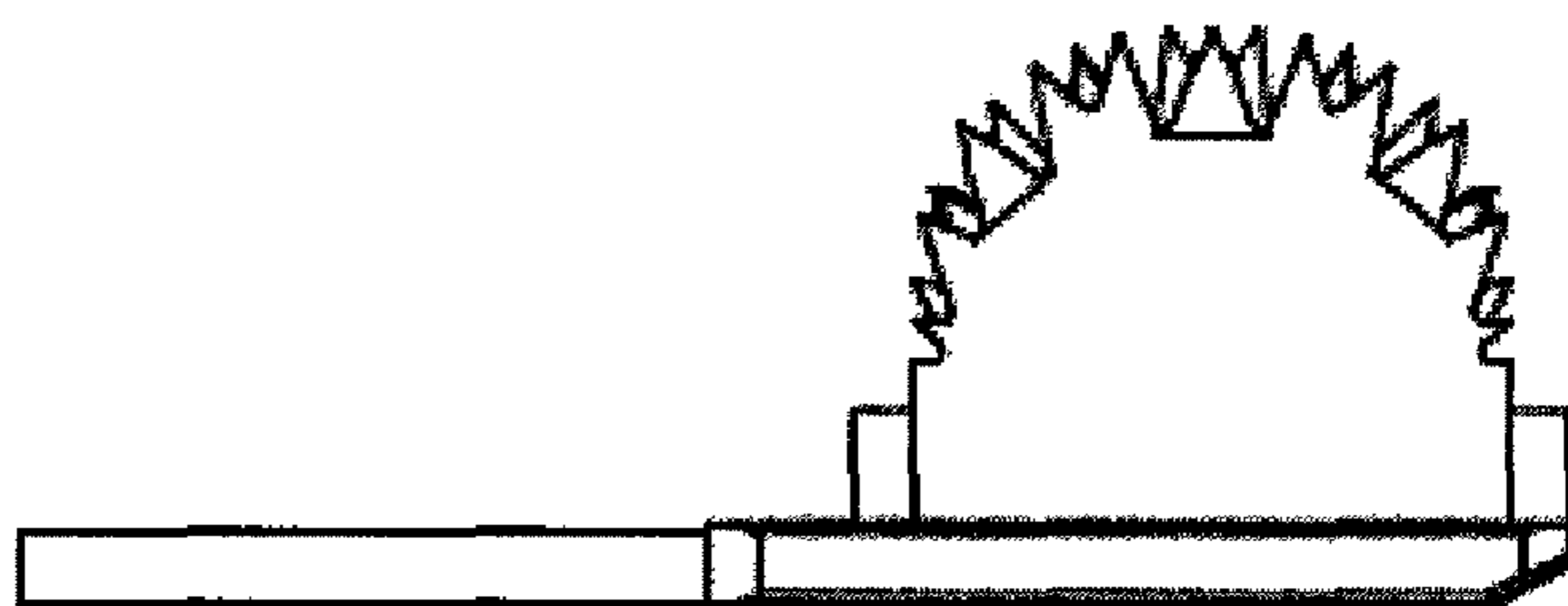
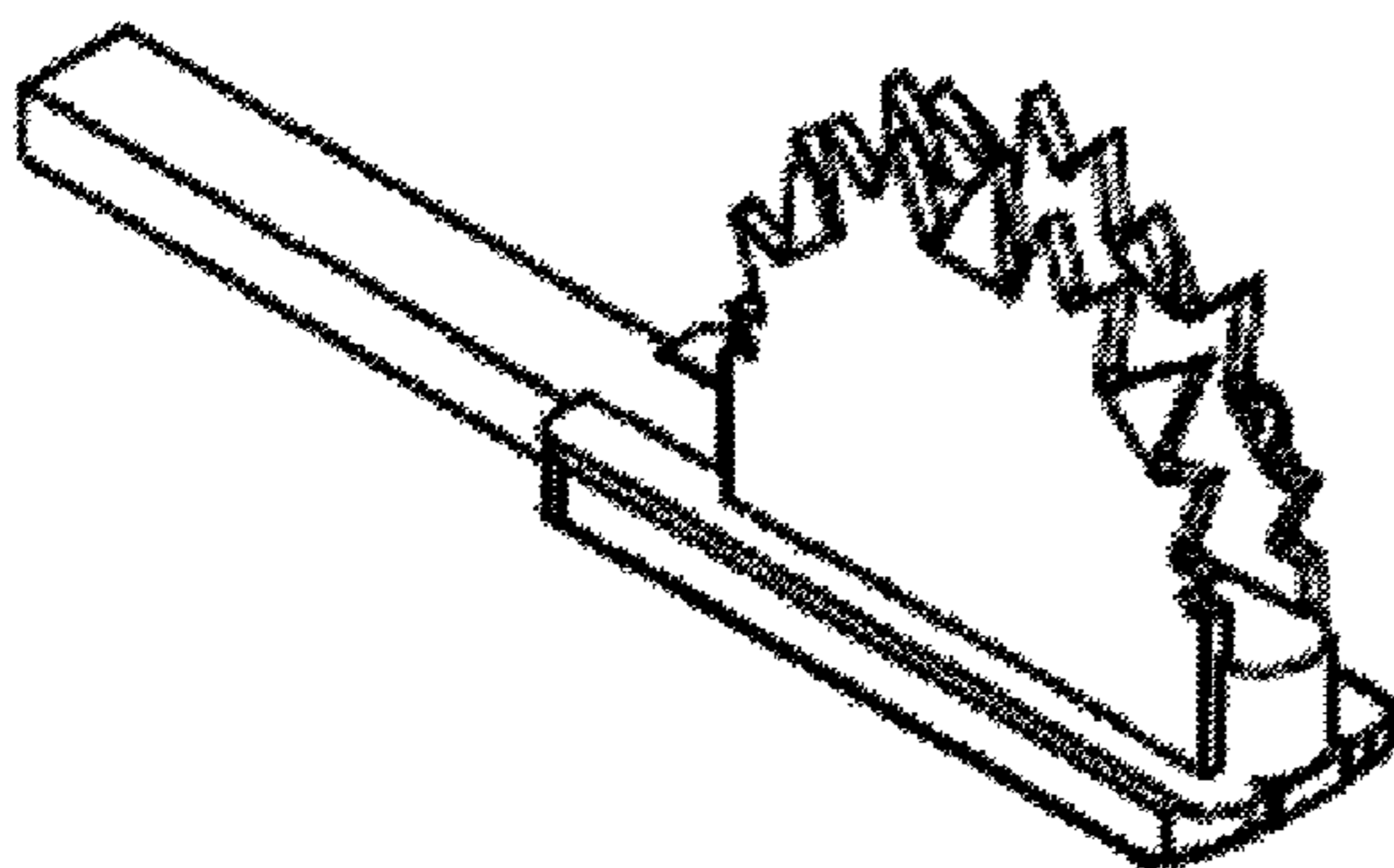

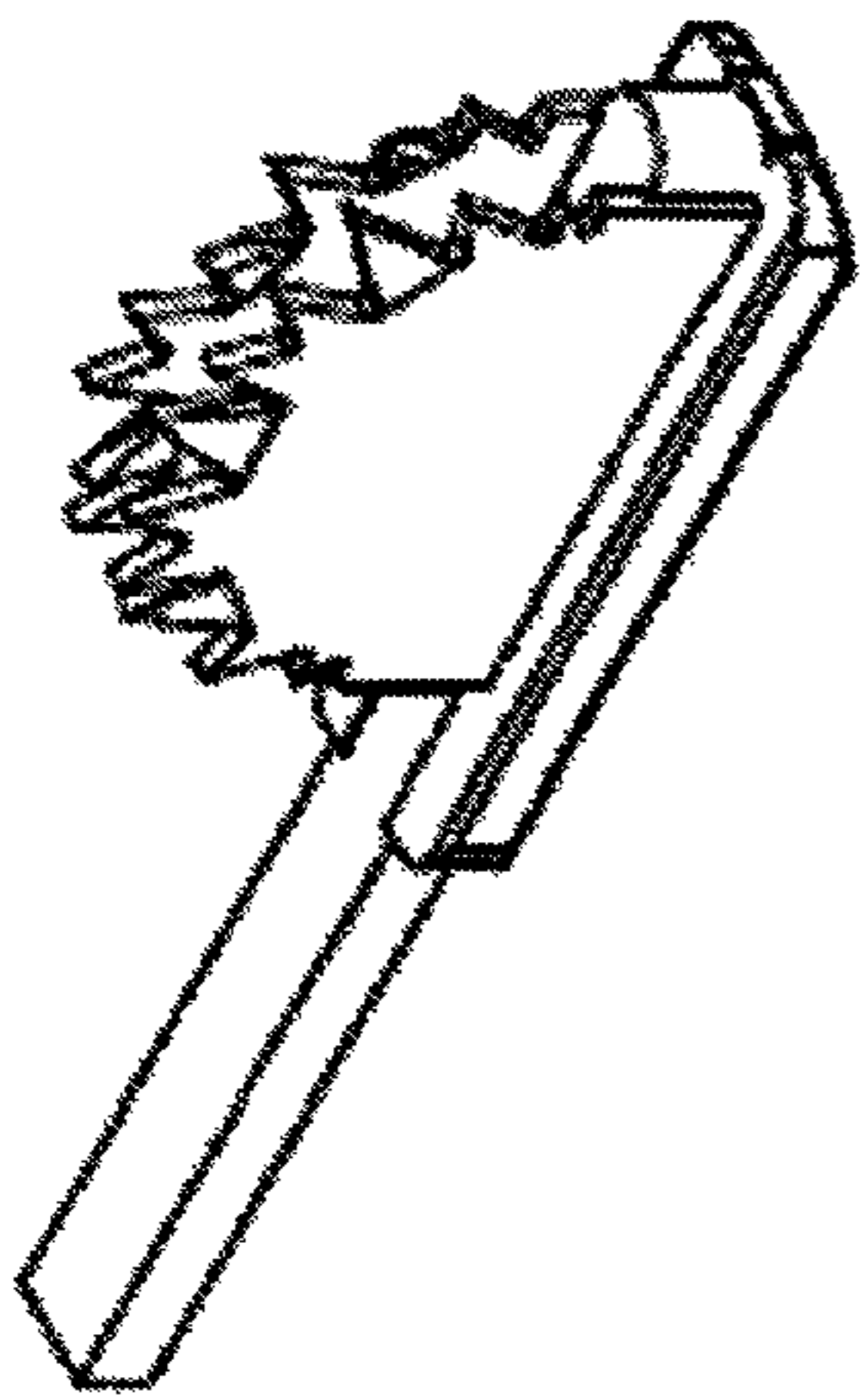

FIG. 1

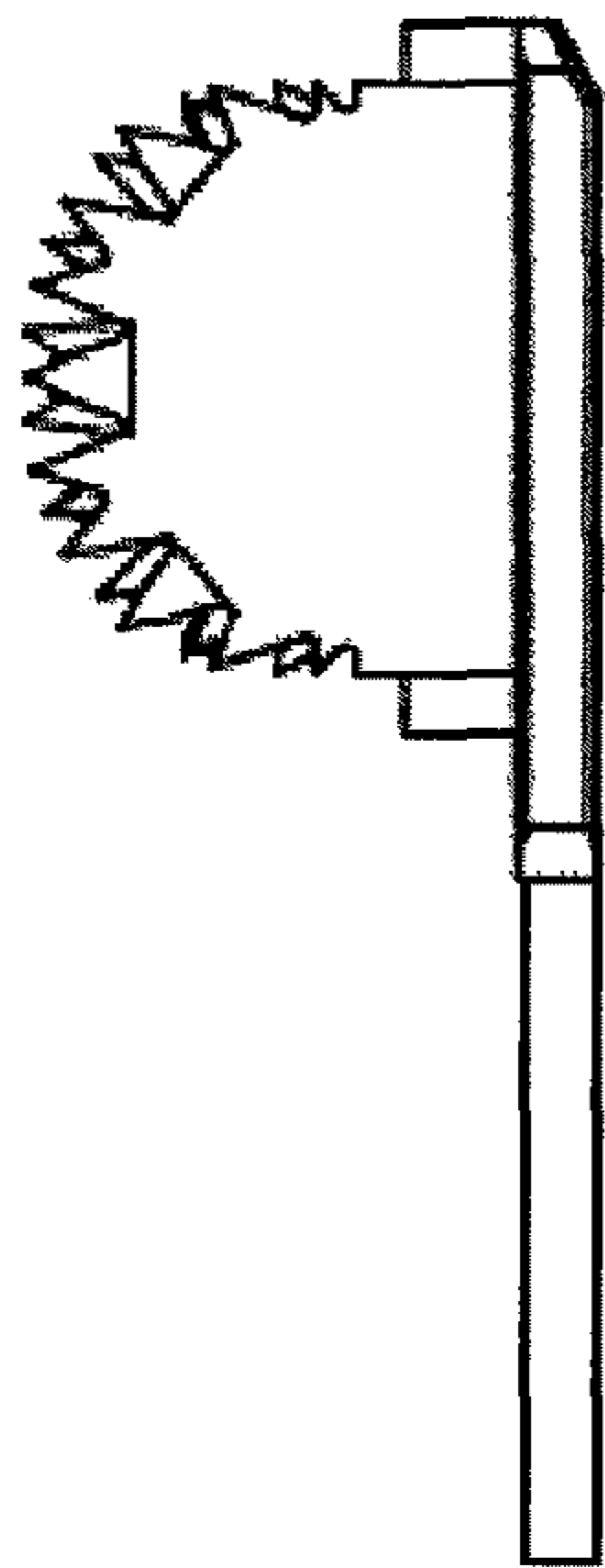

FIG. 2

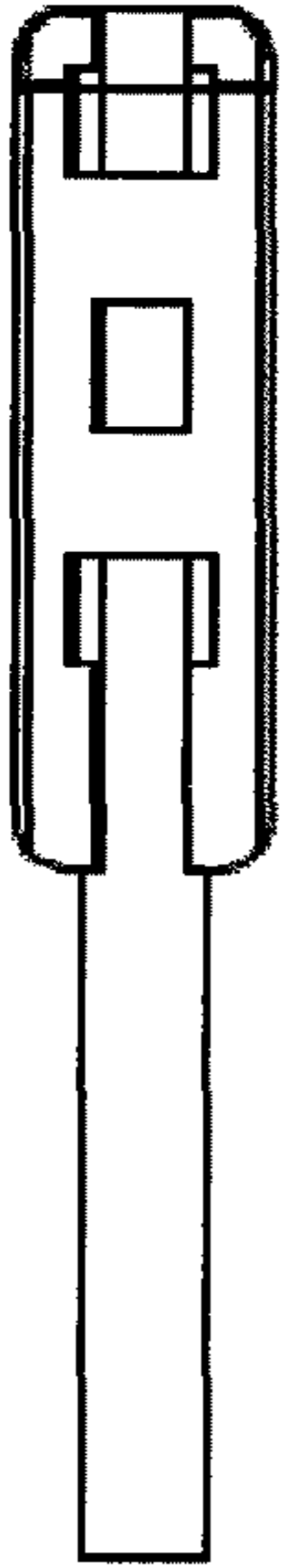

FIG. 3

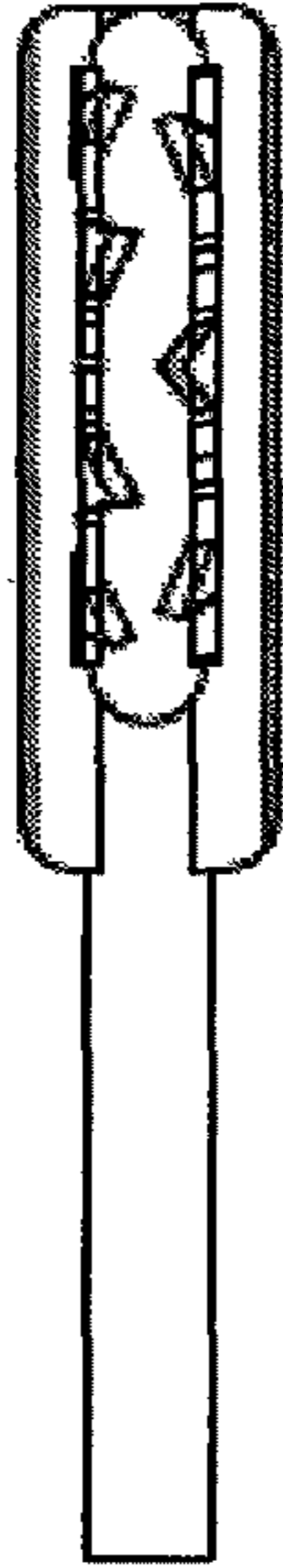

FIG. 4

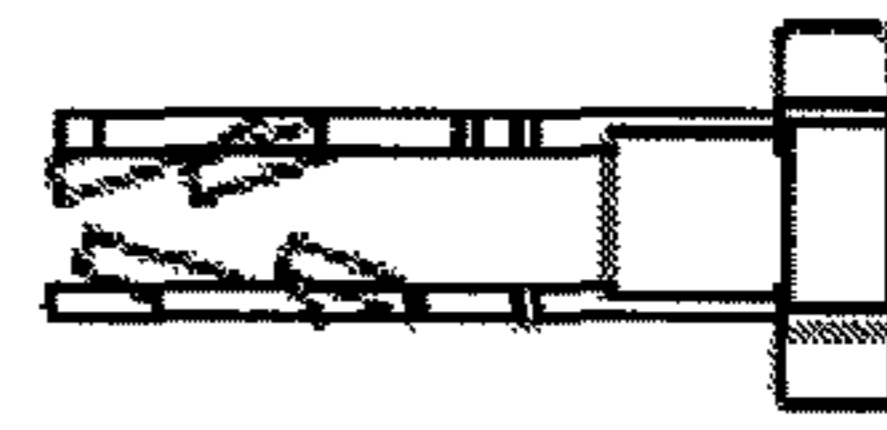

FIG. 6

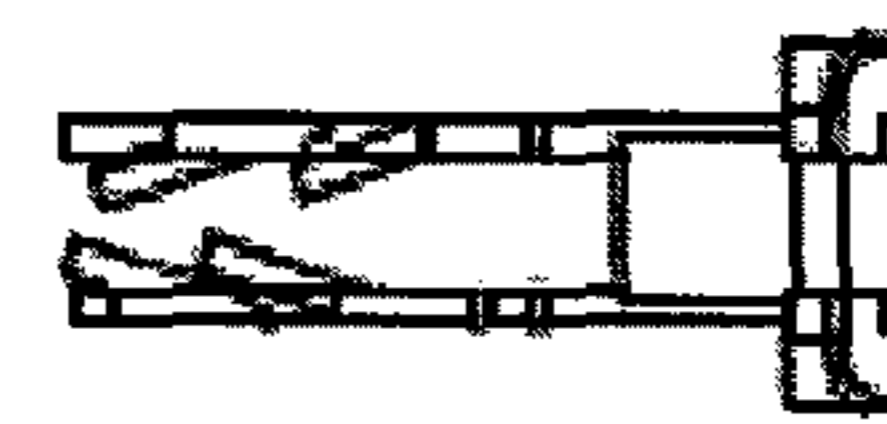

FIG. 5

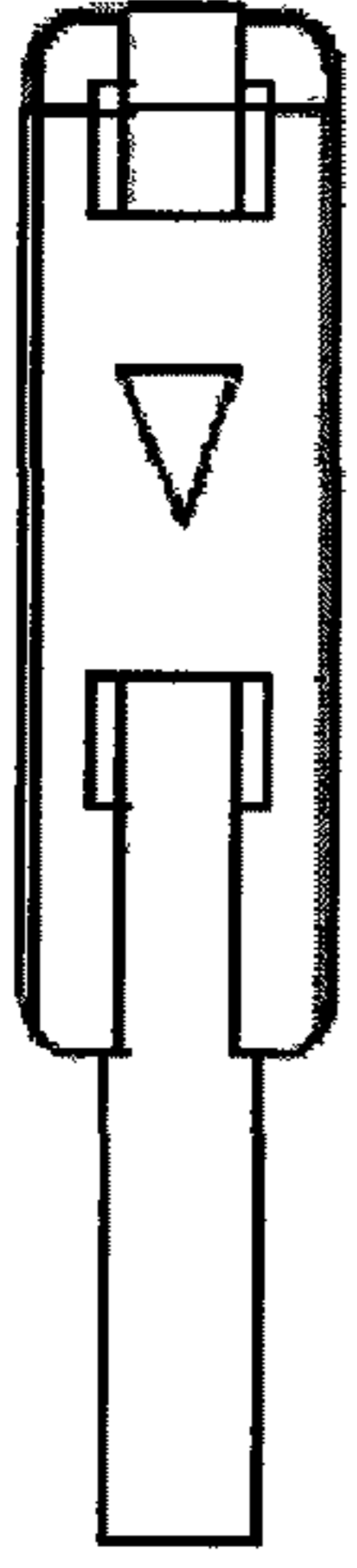

FIG. 9

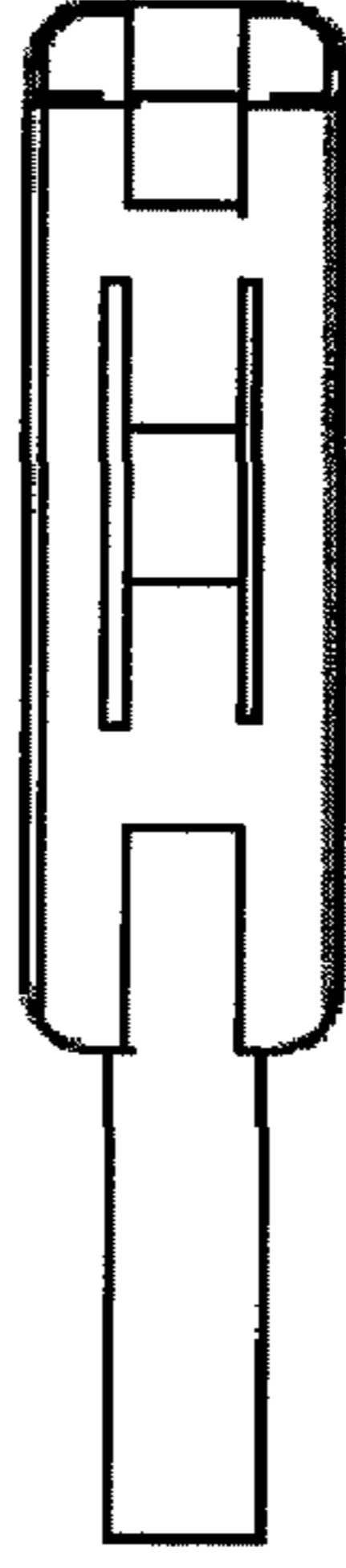

FIG. 12

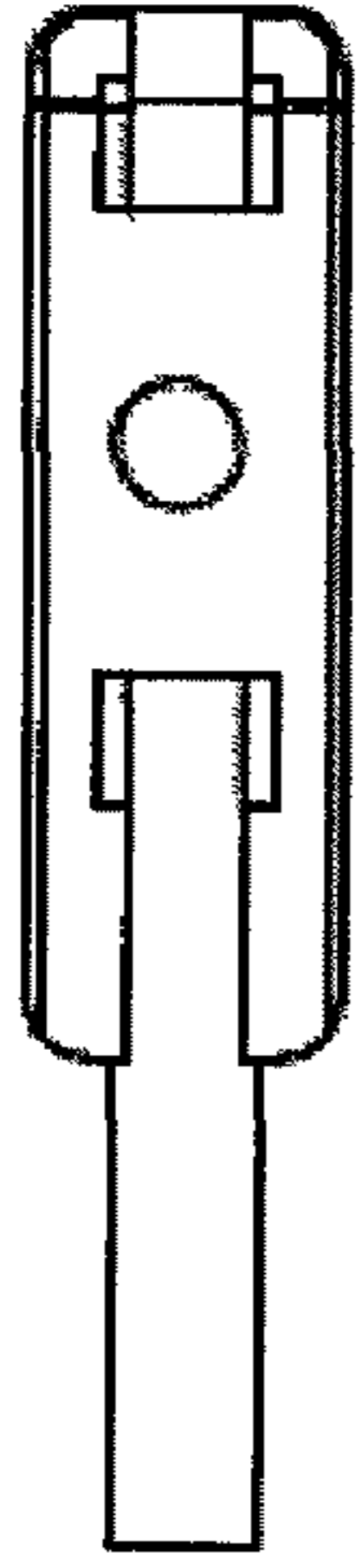

FIG. 8

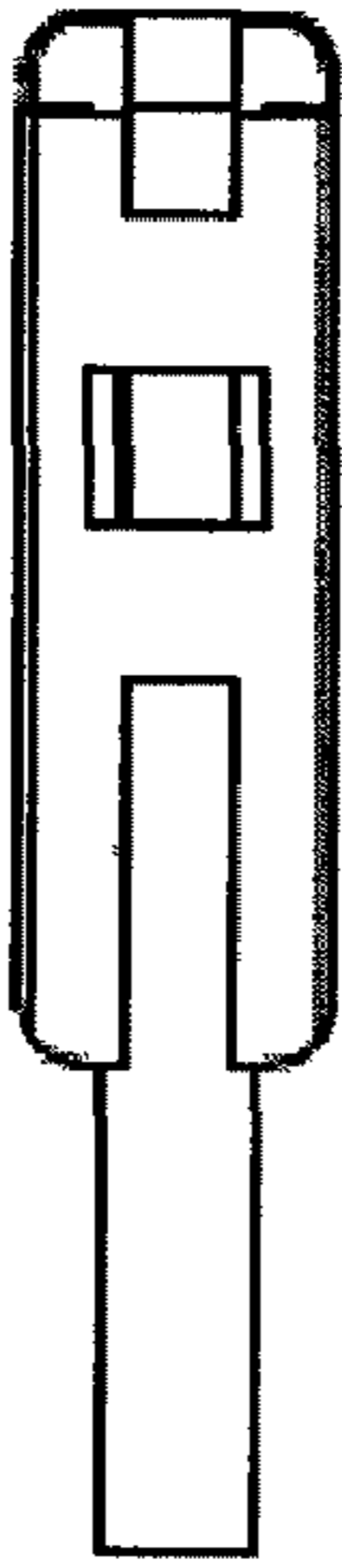

FIG. 11

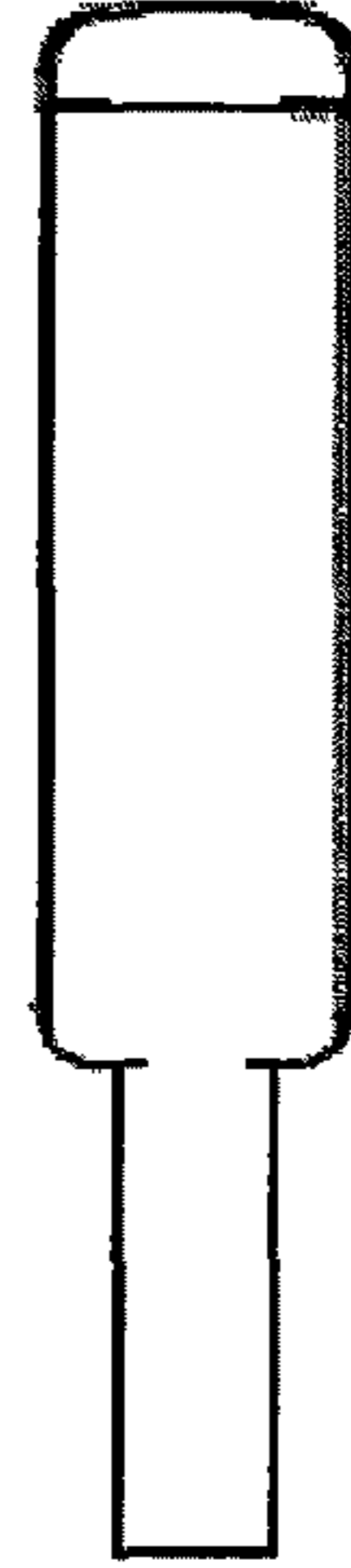

FIG. 14

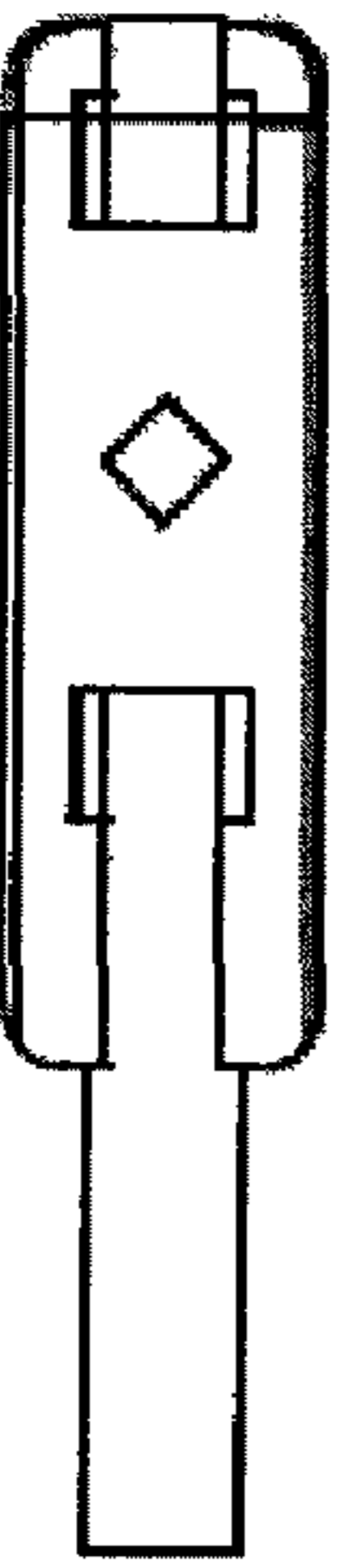

FIG. 7

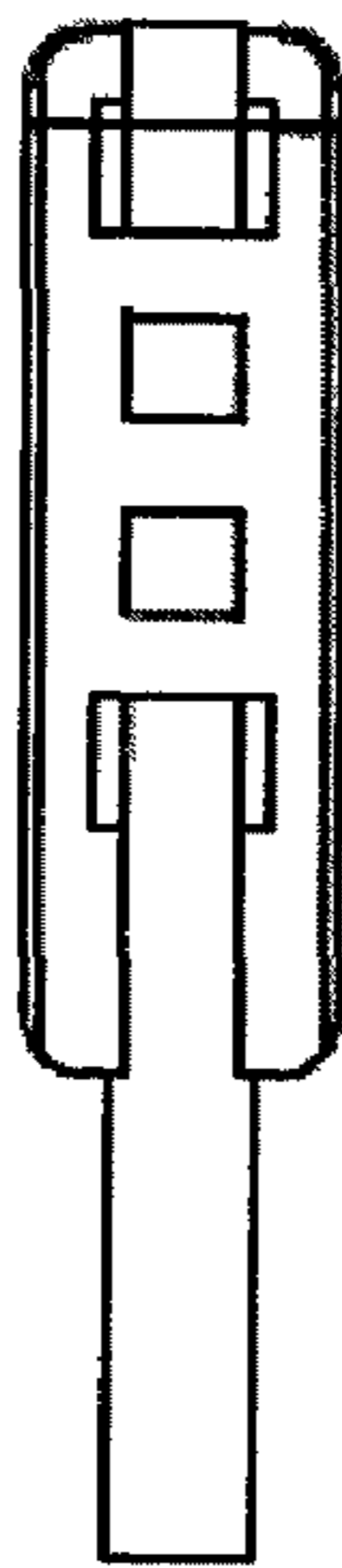

FIG. 10

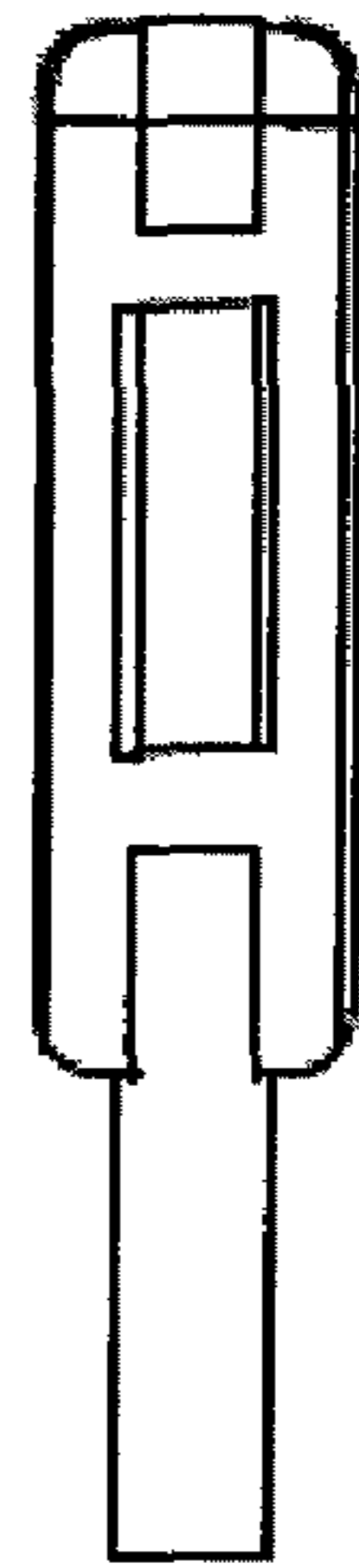

FIG. 13