



US00D622251S

(12) **United States Design Patent**
Kim et al.

(10) **Patent No.:** **US D622,251 S**

(45) **Date of Patent:** **** Aug. 24, 2010**

(54) **MOBILE PHONE**

(75) Inventors: **Bo-Ra Kim**, Seoul (KR); **Sang-Min Hyun**, Seoul (KR); **Nam-Mi Kim**, Seoul (KR)

(73) Assignee: **Samsung Electronics Co., Ltd.**, Suwon-si (KR)

(**) Term: **14 Years**

(21) Appl. No.: **29/350,940**

(22) Filed: **Nov. 25, 2009**

(30) **Foreign Application Priority Data**

Oct. 15, 2009 (KR) 30-2009-0045443

(51) **LOC (9) Cl.** **14-03**

(52) **U.S. Cl.** **D14/138 AA**

(58) **Field of Classification Search** D14/341-347, D14/147, 496, 203.3, 203.4, 203.7, 138 AA, D14/138 R, 138 AD; 455/575.1, 575.4, 556.2; 379/433.01, 433.04

See application file for complete search history.

(56) **References Cited**

U.S. PATENT DOCUMENTS

D548,218 S * 8/2007 Hong et al. D14/138 AA
D554,612 S * 11/2007 Wang D14/138 AA
D556,749 S * 12/2007 Rak et al. D14/346
D559,223 S * 1/2008 Kim et al. D14/138 AA
D562,312 S * 2/2008 Hu et al. D14/248
D563,378 S * 3/2008 Tseng et al. D14/138 AA
D566,086 S * 4/2008 Hong et al. D14/138 AA
D566,094 S * 4/2008 Kim et al. D14/138 AA
D573,128 S * 7/2008 Lee et al. D14/138 AA
D576,988 S * 9/2008 Kim et al. D14/138 AA
D582,372 S * 12/2008 Lee et al. D14/138 AA
D584,262 S * 1/2009 Hu et al. D14/138 AA

D593,554 S * 6/2009 Griffin et al. D14/346
D597,051 S * 7/2009 Kim et al. D14/138 AA
D597,511 S * 8/2009 Park D14/138 AA
D598,915 S * 8/2009 Rak et al. D14/346
D599,316 S * 9/2009 Hong et al. D14/138 AA
D601,540 S * 10/2009 Kim et al. D14/138 AA
D603,831 S * 11/2009 Ho et al. D14/138 AA
D603,833 S * 11/2009 Ho et al. D14/138 AA
D606,540 S * 12/2009 Liao et al. D14/346

(Continued)

OTHER PUBLICATIONS

Samsung B7330 OmniaPRO telephone, announced Sep. 2009, [online], [site visited Mar. 26, 2010]. Available from Internet, <URL: <http://www.gsmarena.com>>.*

(Continued)

Primary Examiner—Jeffrey D Asch
(74) *Attorney, Agent, or Firm*—NSIP Law

(57) **CLAIM**

The ornamental design for a mobile phone, as shown and described.

DESCRIPTION

FIG. 1 is a perspective view of a mobile phone;
FIG. 2 is a front view of the mobile phone of FIG. 1;
FIG. 3 is a rear view of the mobile phone of FIG. 1;
FIG. 4 is a left-side view of the mobile phone of FIG. 1;
FIG. 5 is a right-side view of the mobile phone of FIG. 1;
FIG. 6 is a top plan view of the mobile phone of FIG. 1; and,
FIG. 7 is a bottom plan view of the mobile phone of FIG. 1.

1 Claim, 5 Drawing Sheets

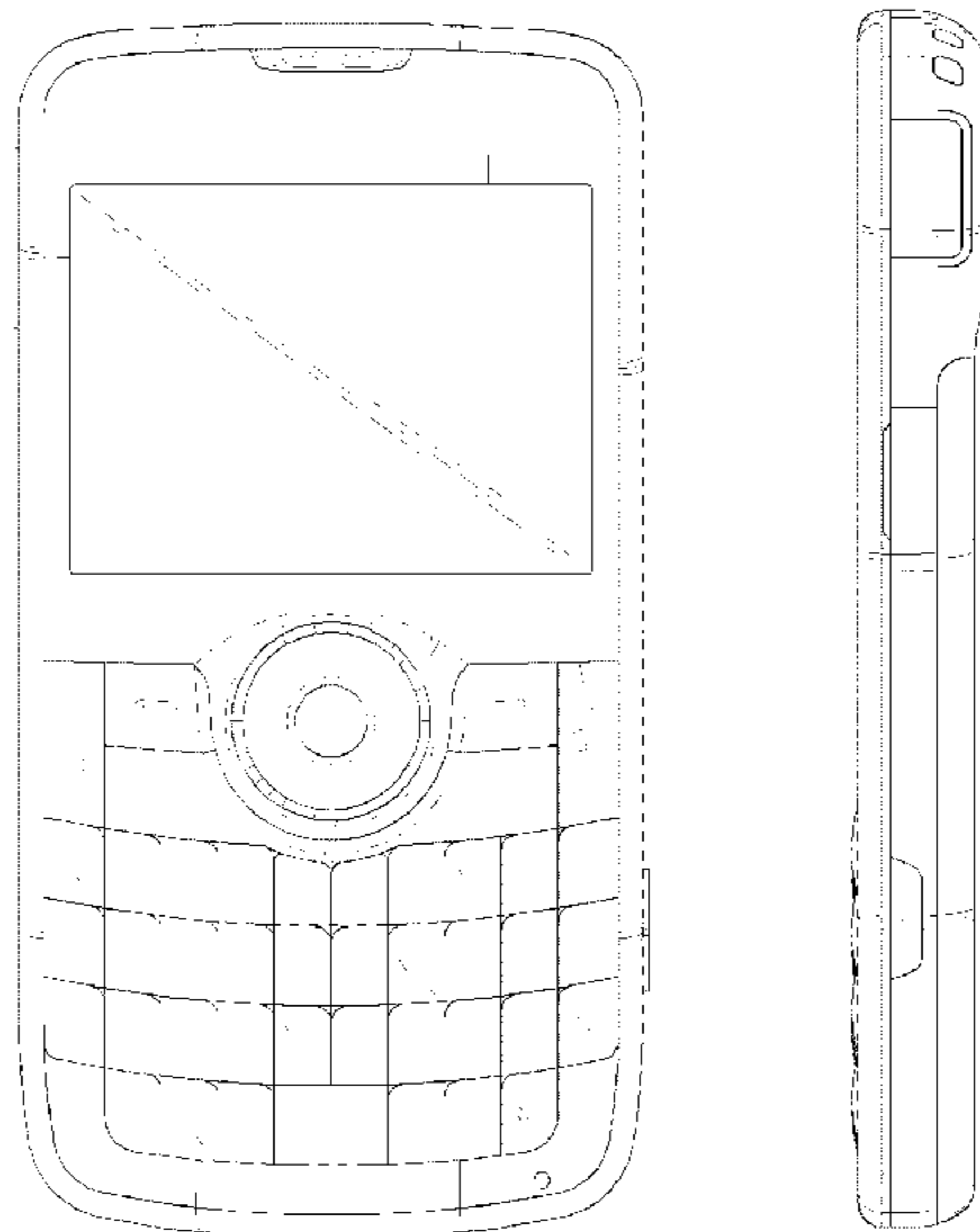

U.S. PATENT DOCUMENTS

D607,866 S * 1/2010 Kim et al. D14/138 AA
D607,868 S * 1/2010 Kim et al. D14/138 AA
D608,328 S * 1/2010 Nilsen et al. D14/138 AA
D609,234 S * 2/2010 Corley et al. D14/346
D614,159 S * 4/2010 Lee et al. D14/138 AA

OTHER PUBLICATIONS

Motorola C168 telephone, announced 3rd quarter 2005, [online], [site visited Mar. 26, 2010]. Available from Internet ,<URL: <http://www.gsmarena.com>>.*

Motorola Q 11 telephone, announced Oct. 2008, [online], [site visited Mar. 26, 2010]. Available from Internet ,<URL: <http://www.gsmarena.com>>.*

HP iPAQ 910c telephone, announced Jul. 2009, [online], [site visited Mar. 26, 2010]. Available from Internet ,<URL: <http://www.gsmarena.com>>.*

Motorola Q 9h telephone, announced Feb. 2007, [online], [site visited Mar. 26, 2010]. Available from Internet ,<URL: <http://www.gsmarena.com>>.*

HP iPAQ Glisten telephone, announced Jul. 2009, [online], [site visited Mar. 26, 2010]. Available from Internet ,<URL: <http://www.gsmarena.com>>.*

iNQ Chat 3G telephone, announced Oct. 2009, [online], [site visited Mar. 26, 2010]. Available from Internet ,<URL: <http://www.gsmarena.com>>.*

Samsung i770 Saga telephone, announced Nov. 2008, [online], [site visited Mar. 26, 2010]. Available from Internet ,<URL: <http://www.gsmarena.com>>.*

* cited by examiner

FIG. 1

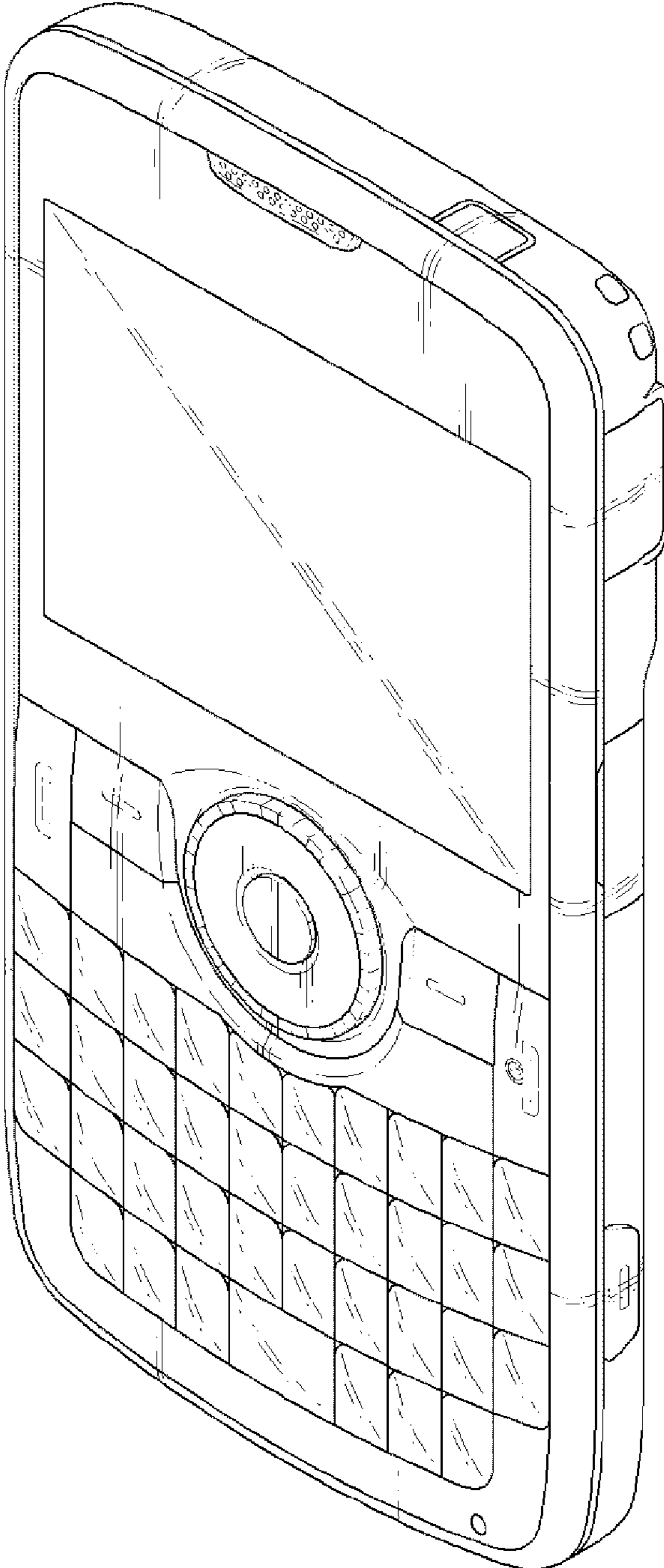

FIG. 2

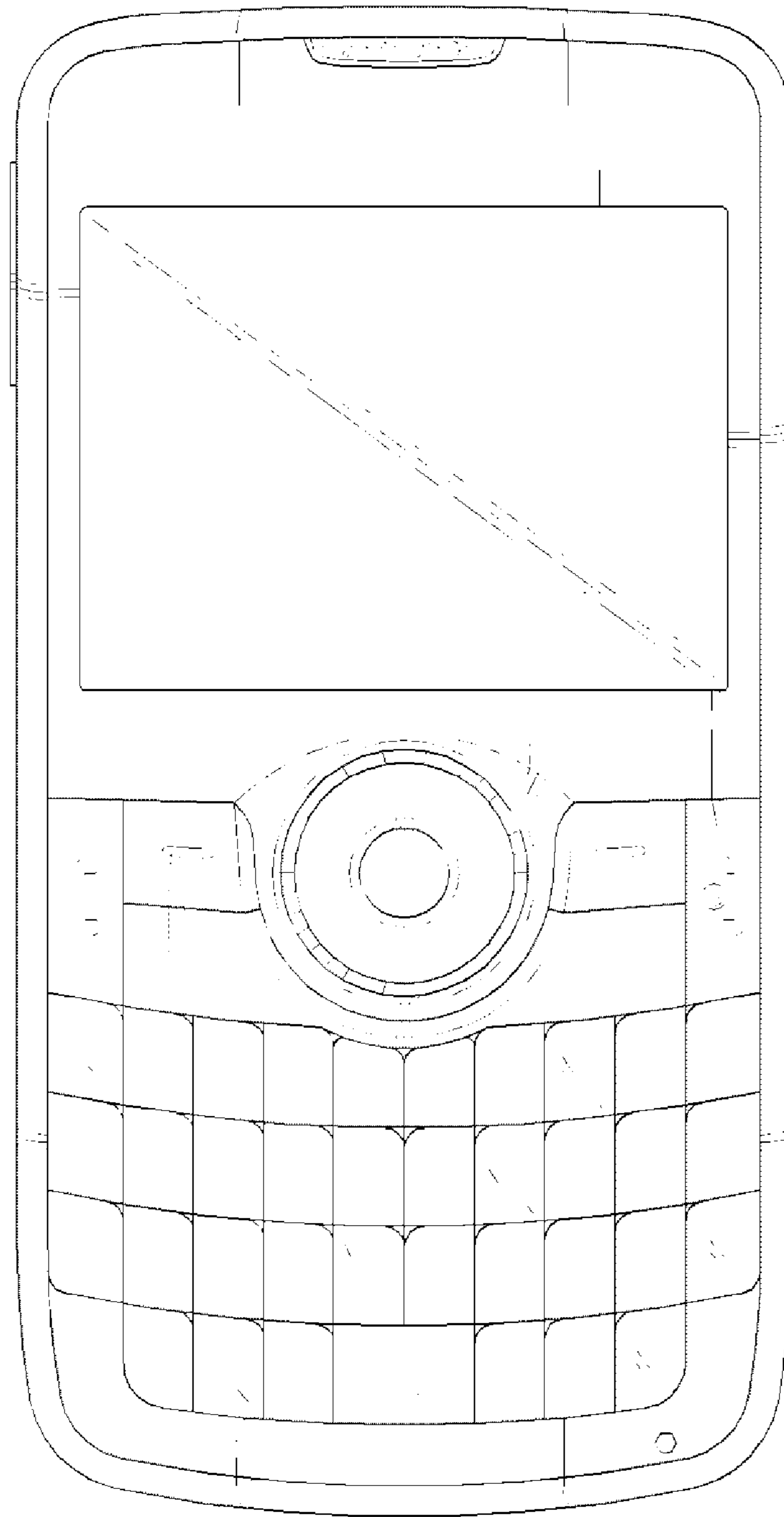

FIG. 3

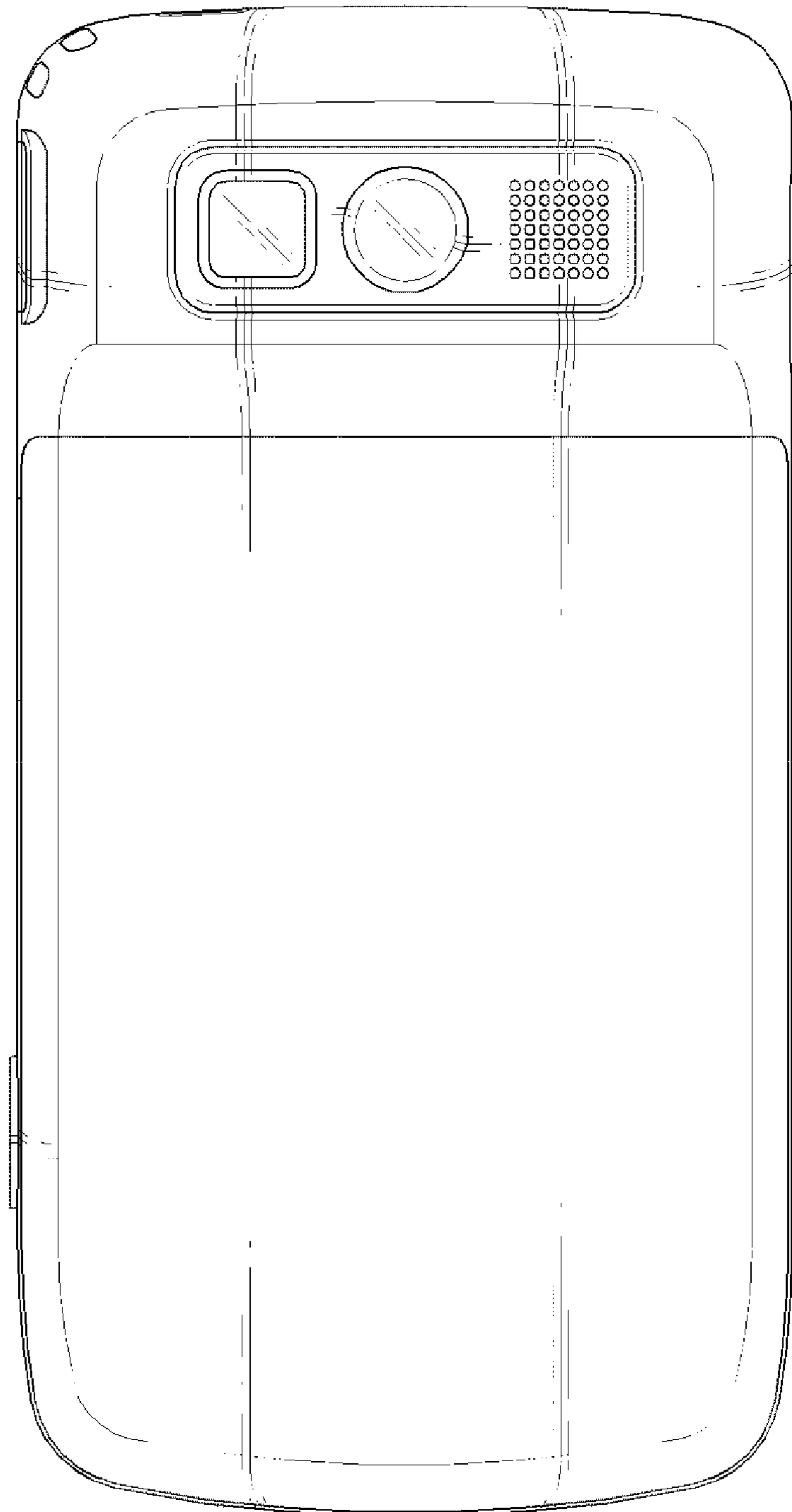

FIG. 4

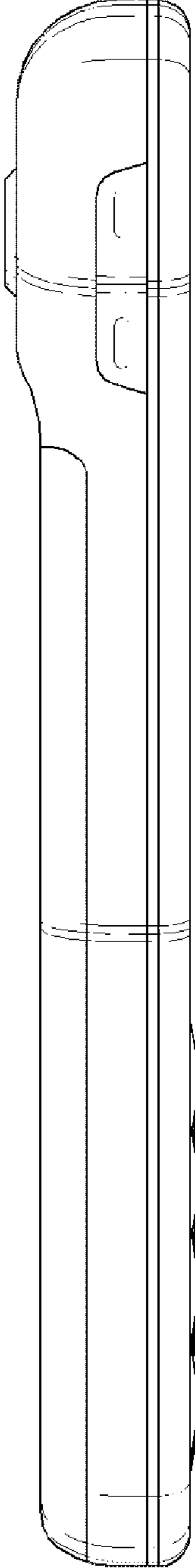

FIG. 5

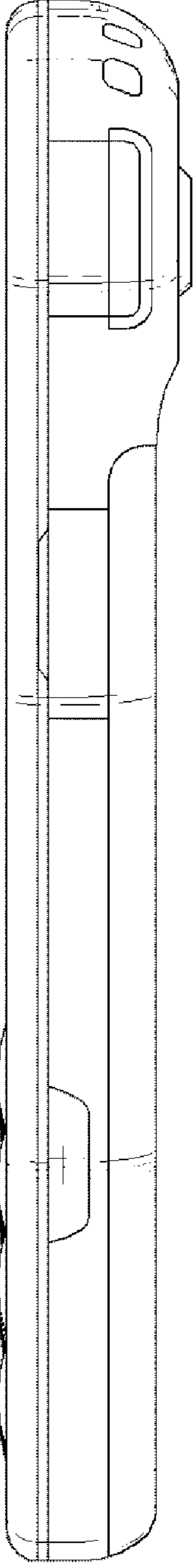

FIG. 6

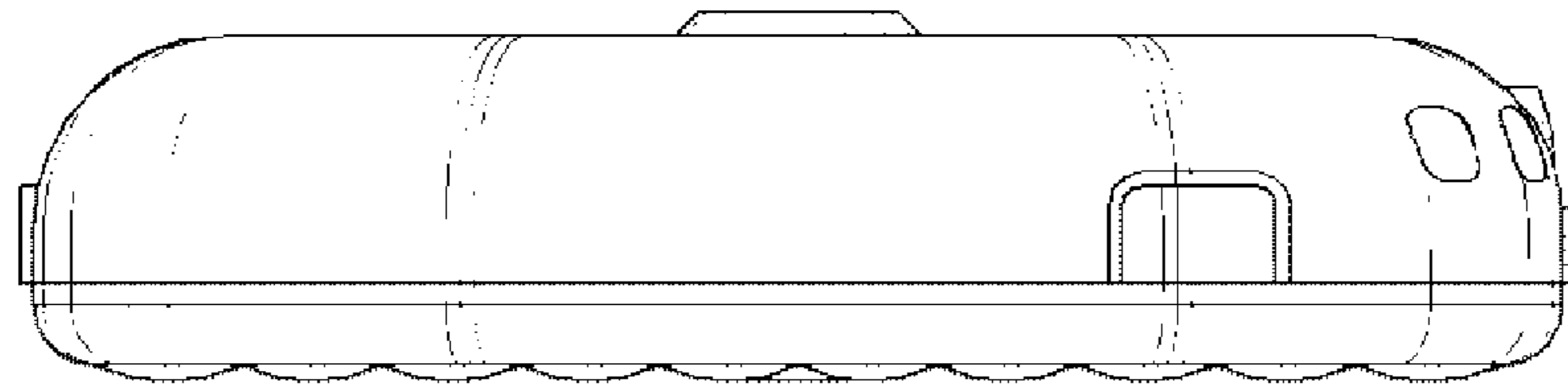
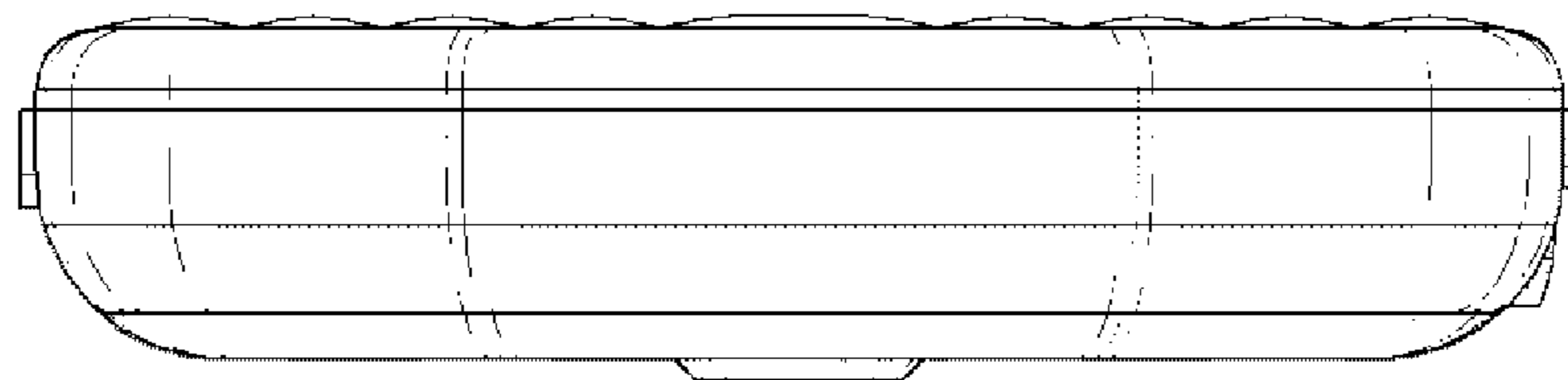

FIG. 7



UNITED STATES PATENT AND TRADEMARK OFFICE
CERTIFICATE OF CORRECTION

PATENT NO. : Des. 622,251 S
APPLICATION NO. : 29/350940
DATED : Aug. 24, 2010
INVENTOR(S) : Kim et al.

Page 1 of 8

It is certified that error appears in the above-identified patent and that said Letters Patent is hereby corrected as shown below:

The Title Page, showing an illustrative figure, should be deleted and substitute therefor the attached title page.

Please replace all the drawings with new Figures 1-7.

Signed and Sealed this

Fourteenth Day of December, 2010

A handwritten signature in black ink that reads "David J. Kappos". The signature is written in a cursive style with a large, prominent "D" and "K".

David J. Kappos
Director of the United States Patent and Trademark Office

(12) **United States Design Patent**
Kim et al.

(10) **Patent No.:** **US D622,251 S**
(45) **Date of Patent:** **** Aug. 24, 2010**

(54) **MOBILE PHONE**

(75) Inventors: **Bo-Ra Kim**, Seoul (KR); **Sang-Min Hyun**, Seoul (KR); **Nam-Mi Kim**, Seoul (KR)

(73) Assignee: **Samsung Electronics Co., Ltd.**, Suwon-si (KR)

(**) **Term:** **14 Years**

(21) **Appl. No.:** **29/350,940**

(22) **Filed:** **Nov. 25, 2009**

(30) **Foreign Application Priority Data**
 Oct. 15, 2009 (KR) 30-2009-0045443

(51) **LOC (9) Cl.** **14-03**
(52) **U.S. Cl.** **D14/138 AA**
(58) **Field of Classification Search** **D14/341-347,**
D14/147, 496, 203.3, 203.4, 203.7, 138 AA,
D14/138 R, 138 AD; 455/575.1, 575.4, 556.2;
379/433.01, 433.04

See application file for complete search history.

(56) **References Cited**

U.S. PATENT DOCUMENTS

- D548,218 S * 8/2007 Hong et al. D14/138 AA
- D554,612 S * 11/2007 Wang D14/138 AA
- D556,749 S * 12/2007 Rak et al. D14/346
- D559,223 S * 1/2008 Kim et al. D14/138 AA
- D562,312 S * 2/2008 Hu et al. D14/248
- D563,378 S * 3/2008 Tseng et al. D14/138 AA
- D566,086 S * 4/2008 Hong et al. D14/138 AA
- D566,094 S * 4/2008 Kim et al. D14/138 AA
- D573,128 S * 7/2008 Lee et al. D14/138 AA
- D576,988 S * 9/2008 Kim et al. D14/138 AA
- D582,372 S * 12/2008 Lee et al. D14/138 AA
- D584,262 S * 1/2009 Hu et al. D14/138 AA

- D593,554 S * 6/2009 Griffin et al. D14/346
- D597,051 S * 7/2009 Kim et al. D14/138 AA
- D597,511 S * 8/2009 Park D14/138 AA
- D598,915 S * 8/2009 Rak et al. D14/346
- D599,316 S * 9/2009 Hong et al. D14/138 AA
- D601,540 S * 10/2009 Kim et al. D14/138 AA
- D603,831 S * 11/2009 Ho et al. D14/138 AA
- D603,833 S * 11/2009 Ho et al. D14/138 AA
- D606,540 S * 12/2009 Liao et al. D14/346

(Continued)

OTHER PUBLICATIONS

Samsung B7330 OmniaPRO telephone, announced Sep. 2009, [online], [site visited Mar. 26, 2010]. Available from Internet, <URL: <http://www.gsmarena.com>>.*

(Continued)

Primary Examiner—Jeffrey D Asch
(74) *Attorney, Agent, or Firm*—NSIP Law

(57) **CLAIM**

The ornamental design for a mobile phone, as shown and described.

DESCRIPTION

FIG. 1 is a perspective view of a mobile phone;
 FIG. 2 is a front view of the mobile phone of FIG. 1;
 FIG. 3 is a rear view of the mobile phone of FIG. 1;
 FIG. 4 is a left-side view of the mobile phone of FIG. 1;
 FIG. 5 is a right-side view of the mobile phone of FIG. 1;
 FIG. 6 is a top plan view of the mobile phone of FIG. 1; and,
 FIG. 7 is a bottom plan view of the mobile phone of FIG. 1.

1 Claim, 5 Drawing Sheets

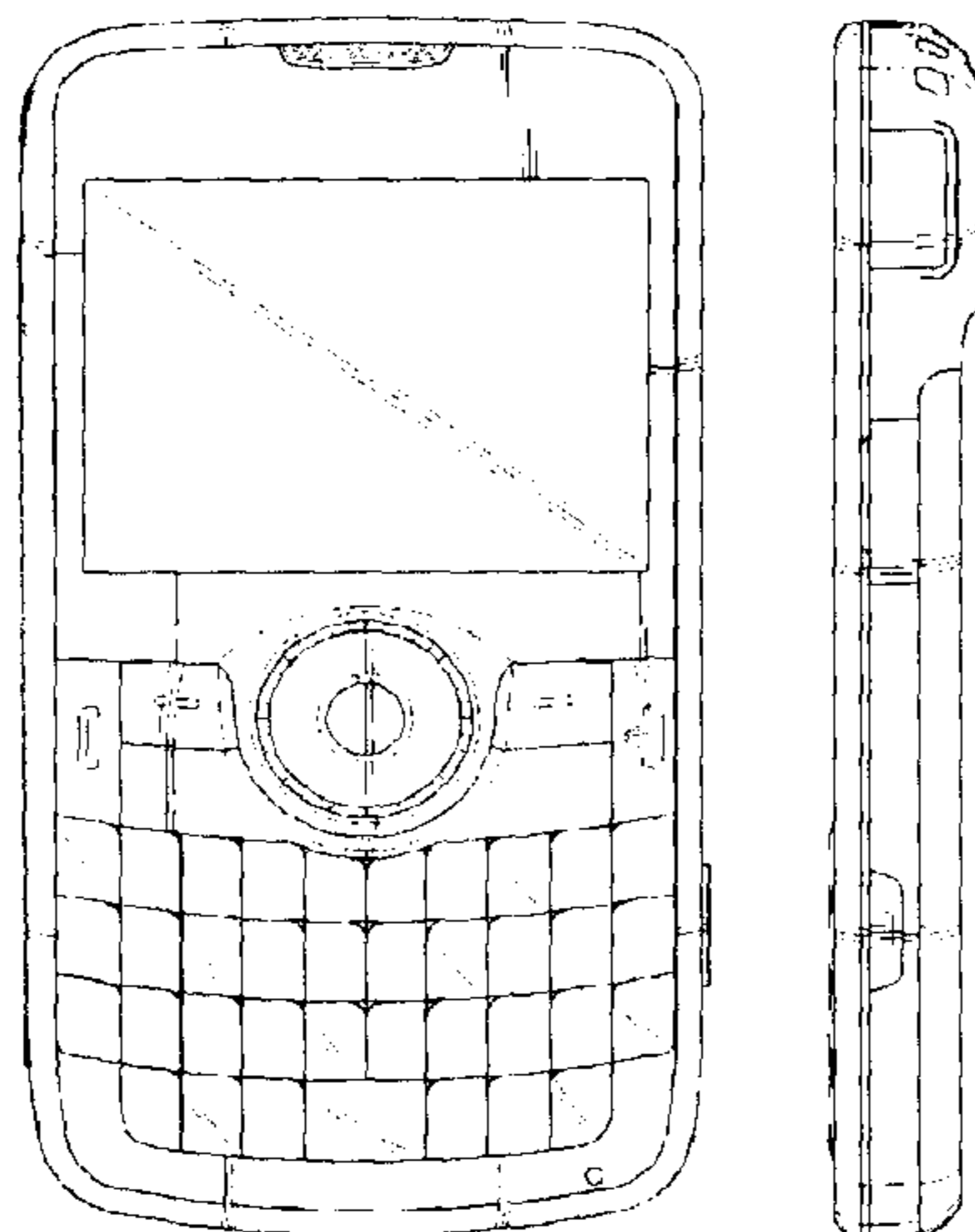

US D622,251 S

Page 2

U.S. PATENT DOCUMENTS

- D607,866 S * 1/2010 Kim et al. D14/138 AA
- D607,868 S * 1/2010 Kim et al. D14/138 AA
- D608,328 S * 1/2010 Nilsen et al. D14/138 AA
- D609,234 S * 2/2010 Corley et al. D14/346
- D614,159 S * 4/2010 Lee et al. D14/138 AA

OTHER PUBLICATIONS

Motorola C168 telephone, announced 3rd quarter 2005, [online], [site visited Mar. 26, 2010]. Available from Internet ,<URL: <http://www.gsmarena.com>>.*

Motorola Q 11 telephone, announced Oct. 2008, [online], [site visited Mar. 26, 2010]. Available from Internet ,<URL: <http://www.gsmarena.com>>.*

HP iPAQ 910c telephone, announced Jul. 2009, [online], [site visited Mar. 26, 2010]. Available from Internet ,<URL: <http://www.gsmarena.com>>.*

Motorola Q 9h telephone, announced Feb. 2007, [online], [site visited Mar. 26, 2010]. Available from Internet ,<URL: <http://www.gsmarena.com>>.*

HP iPAQ Glisten telephone, announced Jul. 2009, [online], [site visited Mar. 26, 2010]. Available from Internet ,<URL: <http://www.gsmarena.com>>.*

iNQ Chat 3G telephone, announced Oct. 2009, [online], [site visited Mar. 26, 2010]. Available from Internet ,<URL: <http://www.gsmarena.com>>.*

Samsung i770 Saga telephone, announced Nov. 2008, [online], [site visited Mar. 26, 2010]. Available from Internet ,<URL: <http://www.gsmarena.com>>.*

* cited by examiner

FIG. 1

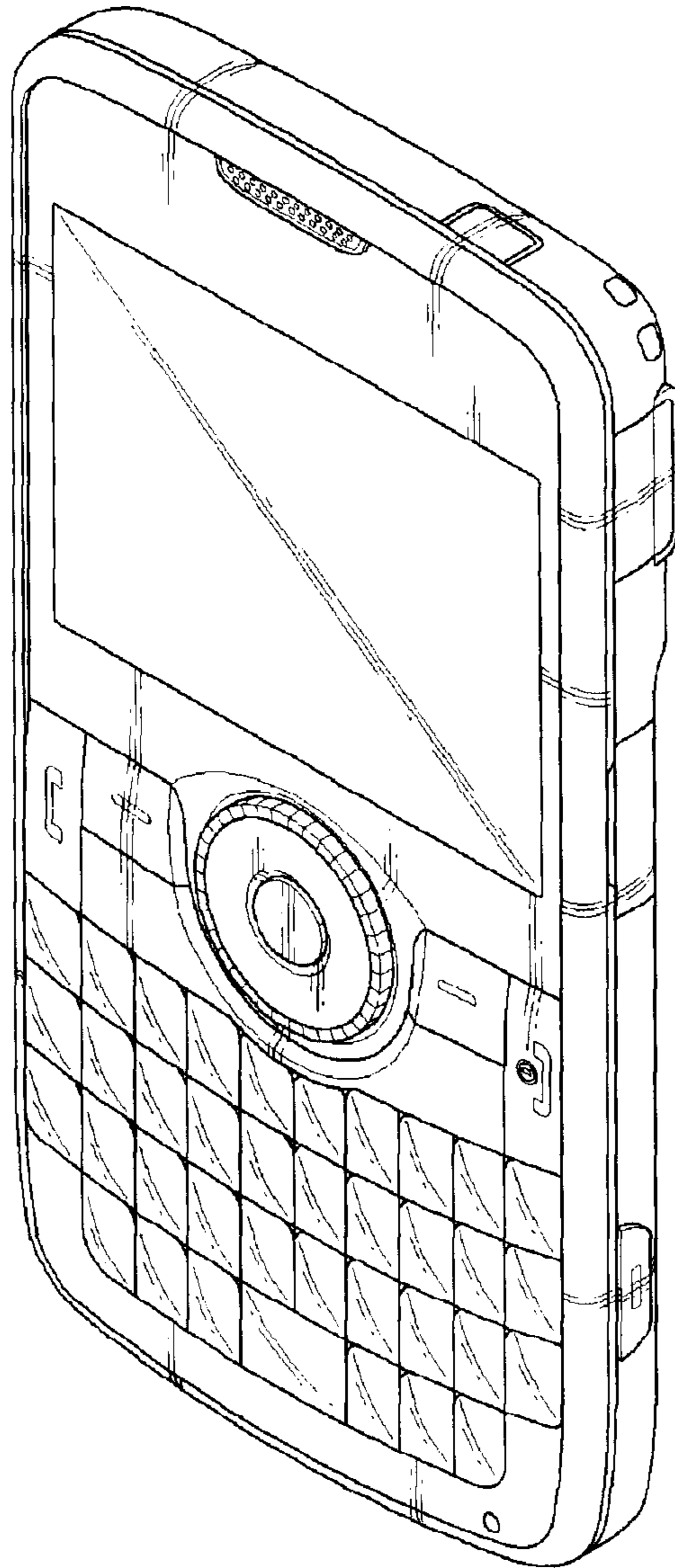

FIG. 2

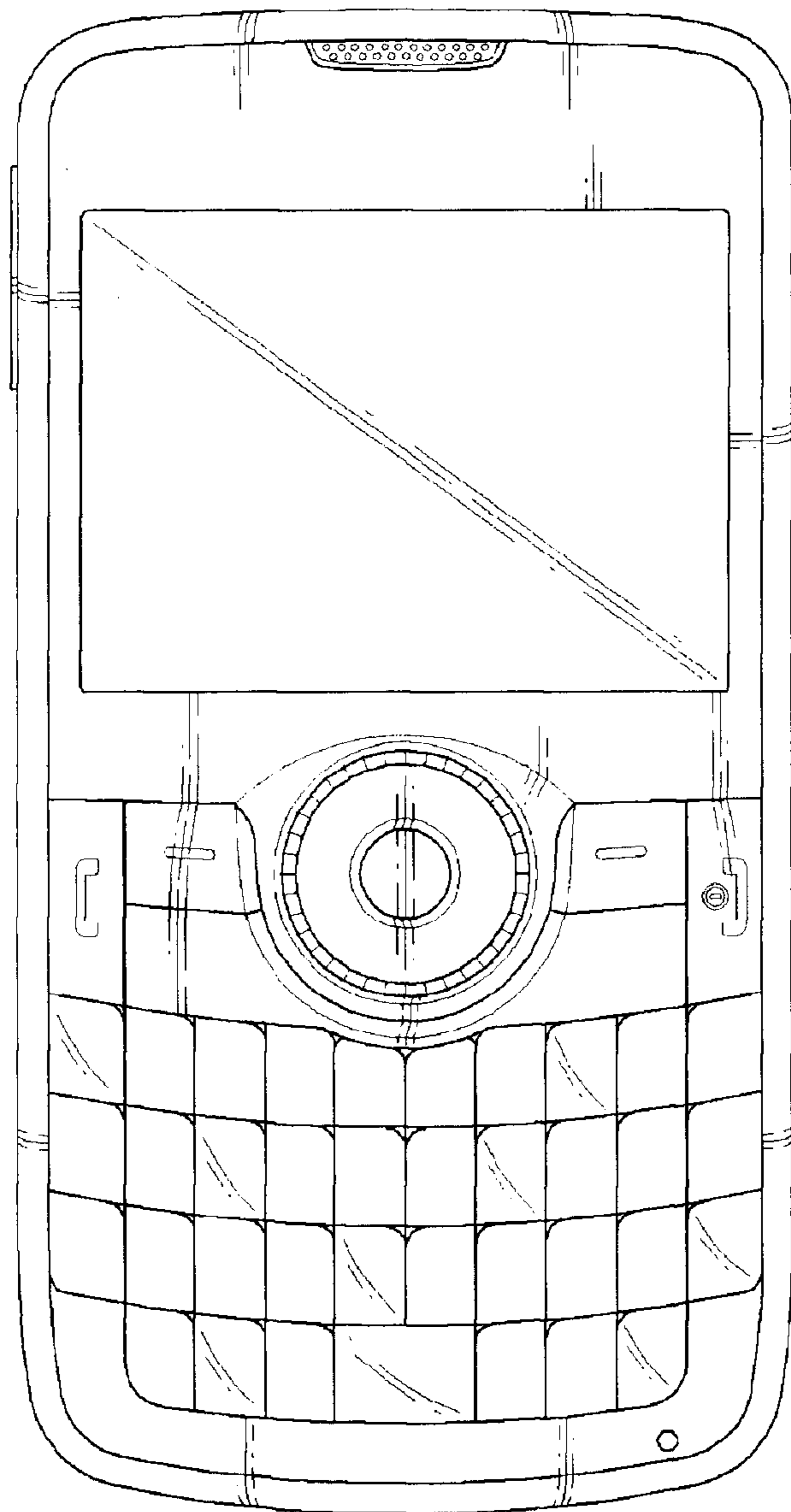

FIG. 3

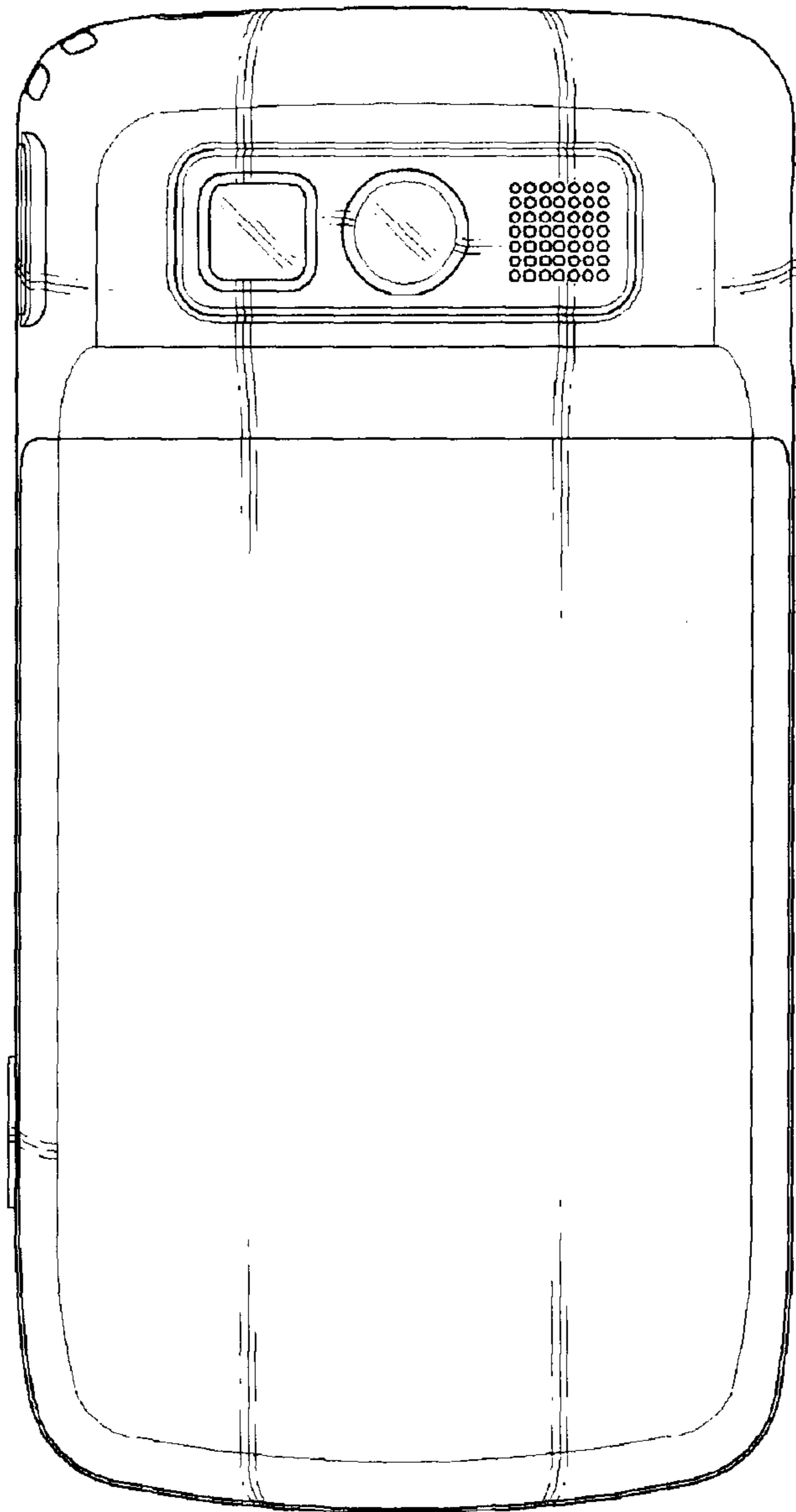

FIG. 4

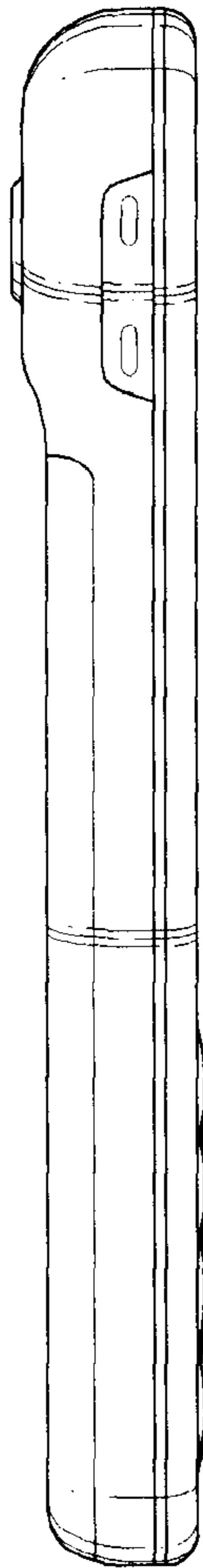

FIG. 5

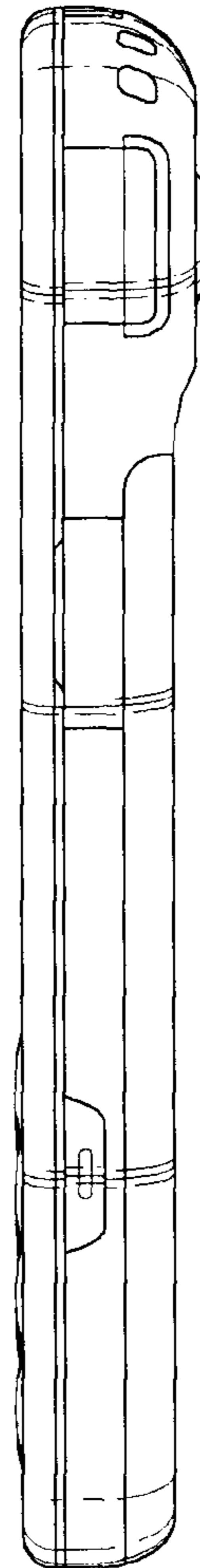

FIG. 6

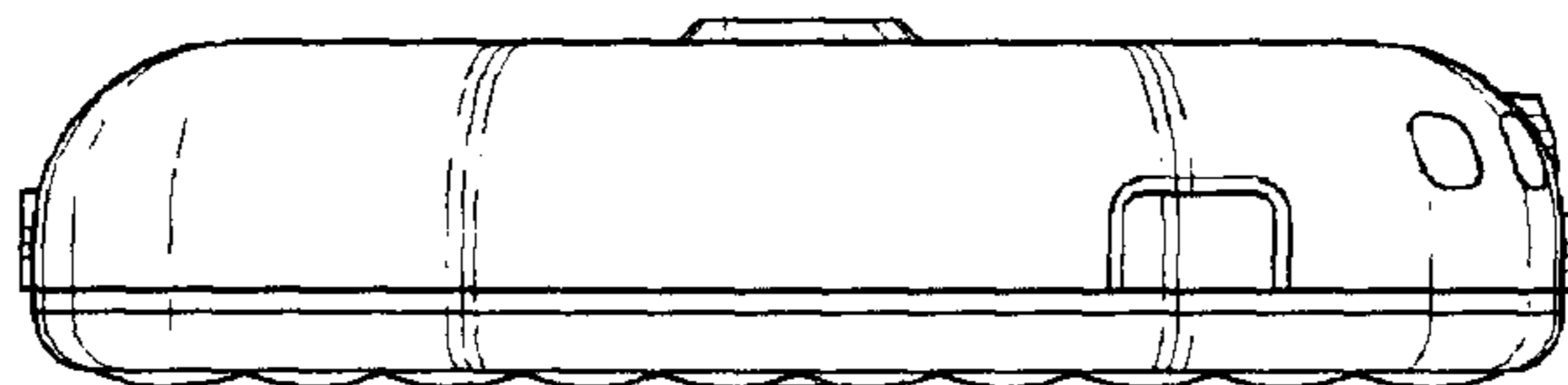

FIG. 7

