



US00D622250S

(12) **United States Design Patent**
Kwon et al.

(10) **Patent No.:** **US D622,250 S**
(45) **Date of Patent:** **** Aug. 24, 2010**

(54) **MOBILE PHONE**

(75) Inventors: **Kyung-Jun Kwon**, Hanam-Si (KR);
Sang-Min Hyun, Seoul (KR); **Nam-Mi Kim**, Seoul (KR)

(73) Assignee: **Samsung Electronics Co., Ltd.**,
Suwon-si (KR)

(**) Term: **14 Years**

(21) Appl. No.: **29/350,935**

(22) Filed: **Nov. 25, 2009**

(30) **Foreign Application Priority Data**

Oct. 15, 2009 (KR) 30-2009-0045441

(51) **LOC (9) Cl.** **14-03**

(52) **U.S. Cl.** **D14/138 G; D14/138 AD**

(58) **Field of Classification Search** D14/138 R,
D14/138 AD, 138 AC, 138 C, 138 G, 191,
D14/203.1–203.8, 496, 138 AA, 138 AB,
D14/247–248, 137, 147, 218, 341–347; D10/65,
D10/78, 104; D13/168; D18/7; 455/566,
455/575.1, 575.3

See application file for complete search history.

(56) **References Cited**

U.S. PATENT DOCUMENTS

D422,972 S * 4/2000 King D14/341
D423,468 S * 4/2000 Jenkins D14/342
D504,120 S * 4/2005 Edoff D14/138 G
D517,038 S * 3/2006 Lee et al. D14/138 AD
7,047,033 B2 * 5/2006 Wyler 455/552.1
D543,193 S * 5/2007 Chung et al. D14/138 AD
D548,713 S * 8/2007 Lee et al. D14/138 AD
D554,635 S * 11/2007 Chung et al. D14/341
D555,137 S * 11/2007 Kim et al. D14/138 AD
7,292,882 B2 * 11/2007 Lee et al. 455/575.4

D563,364 S * 3/2008 Kim et al. D14/138 AB
D571,235 S * 6/2008 Stevens et al. D10/65
D571,798 S * 6/2008 Ogasawara D14/341
D571,799 S * 6/2008 Ogasawara D14/341
D571,800 S * 6/2008 Tamaki et al. D14/345

(Continued)

OTHER PUBLICATIONS

Motorola Sidekick Slide, announced Sep. 2007, [online], [retrieved on May 14, 2008]. Retrieved from Internet ,<URL: <http://www.gsmarena.com>>.*

(Continued)

Primary Examiner—Jeffrey D Asch
Assistant Examiner—Bridget L Eland
(74) *Attorney, Agent, or Firm*—NSIP Law

(57) **CLAIM**

The ornamental design for a mobile phone, as shown and described.

DESCRIPTION

FIG. 1 is a perspective view of a mobile phone;
FIG. 2 is a front view of the mobile phone of FIG. 1;
FIG. 3 is a rear view of the mobile phone of FIG. 1;
FIG. 4 is a left-side view of the mobile phone of FIG. 1;
FIG. 5 is a right-side view of the mobile phone of FIG. 1;
FIG. 6 is a top plan view of the mobile phone of FIG. 1;
FIG. 7 is a bottom plan view of the mobile phone of FIG. 1;
and,
FIG. 8 is a front open view of the mobile phone of FIG. 1.

1 Claim, 6 Drawing Sheets

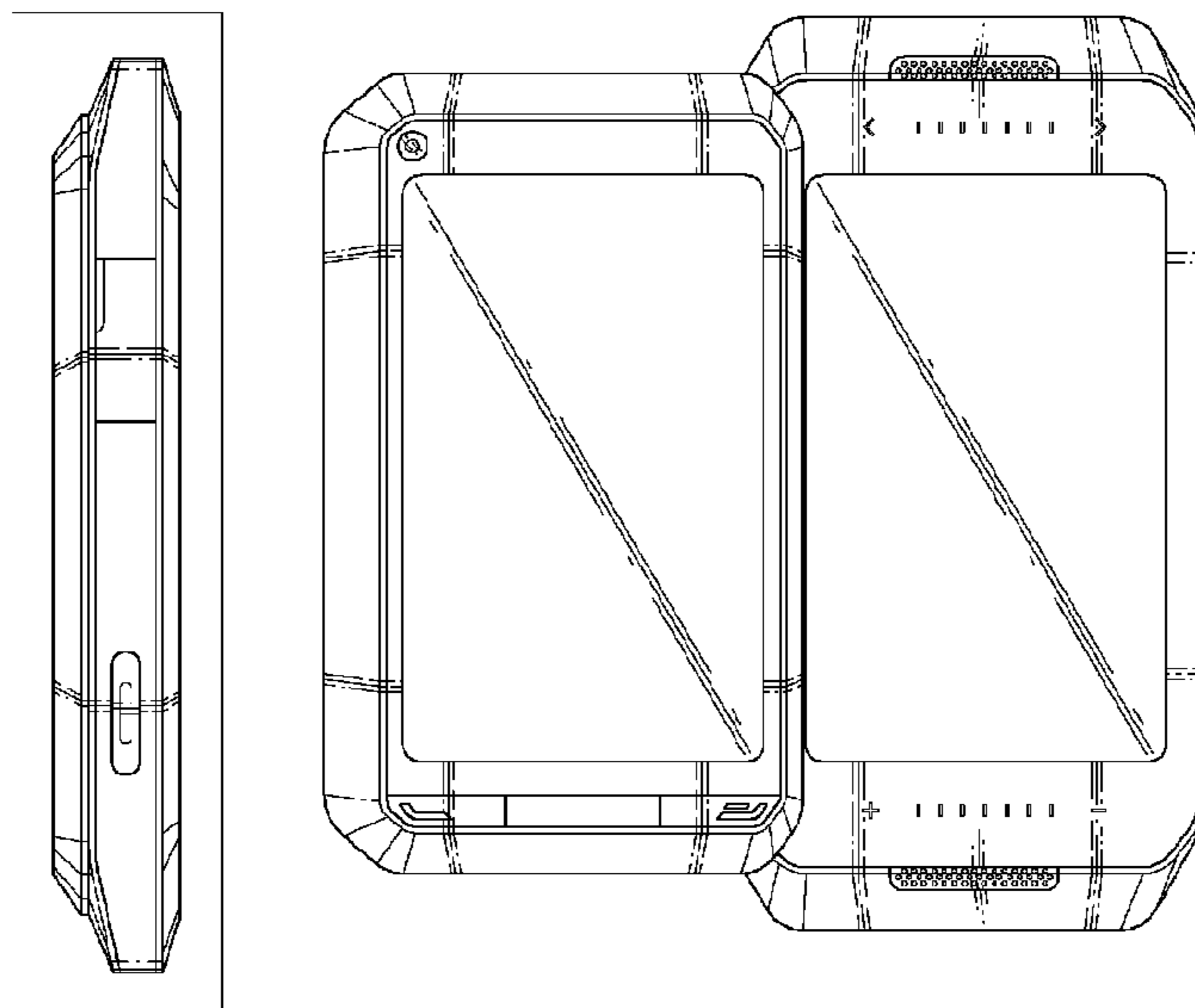

US D622,250 S

Page 2

U.S. PATENT DOCUMENTS

D577,703 S * 9/2008 Lee et al. D14/138 G
D578,983 S * 10/2008 Bang et al. D14/138 AD
D580,400 S * 11/2008 Chung et al. D14/138 AD
D580,401 S * 11/2008 Kim et al. D14/138 AD
D590,388 S * 4/2009 Price et al. D14/345
D590,825 S * 4/2009 Liu D14/341
D604,285 S * 11/2009 Madsen et al. D14/248
D606,507 S * 12/2009 Kim et al. D14/138 G
2005/0043063 A1* 2/2005 Dinn 455/566
2008/0004085 A1* 1/2008 Jung et al. 455/566

2008/0297537 A1* 12/2008 Ishikawa et al. 345/690

OTHER PUBLICATIONS

T-Mobile Sidekick LX 2009, announced Apr. 2009, [online],
[retrieved on May 1, 2009]. Retrieved from Internet ,<URL: <http://www.gsmarena.com>>.*

i-mate Ultimate 9502, announced Oct. 2007, [online], [retrieved on
Dec. 13, 2007]. Retrieved from Internet ,<URL: <http://www.gsmarena.com>>.*

Pantech Duo, announced Oct. 2007, [online], [retrieved on Jan. 18,
2008]. Retrieved from Internet ,<URL: <http://www.gsmarena.com>>.*

* cited by examiner

FIG. 1

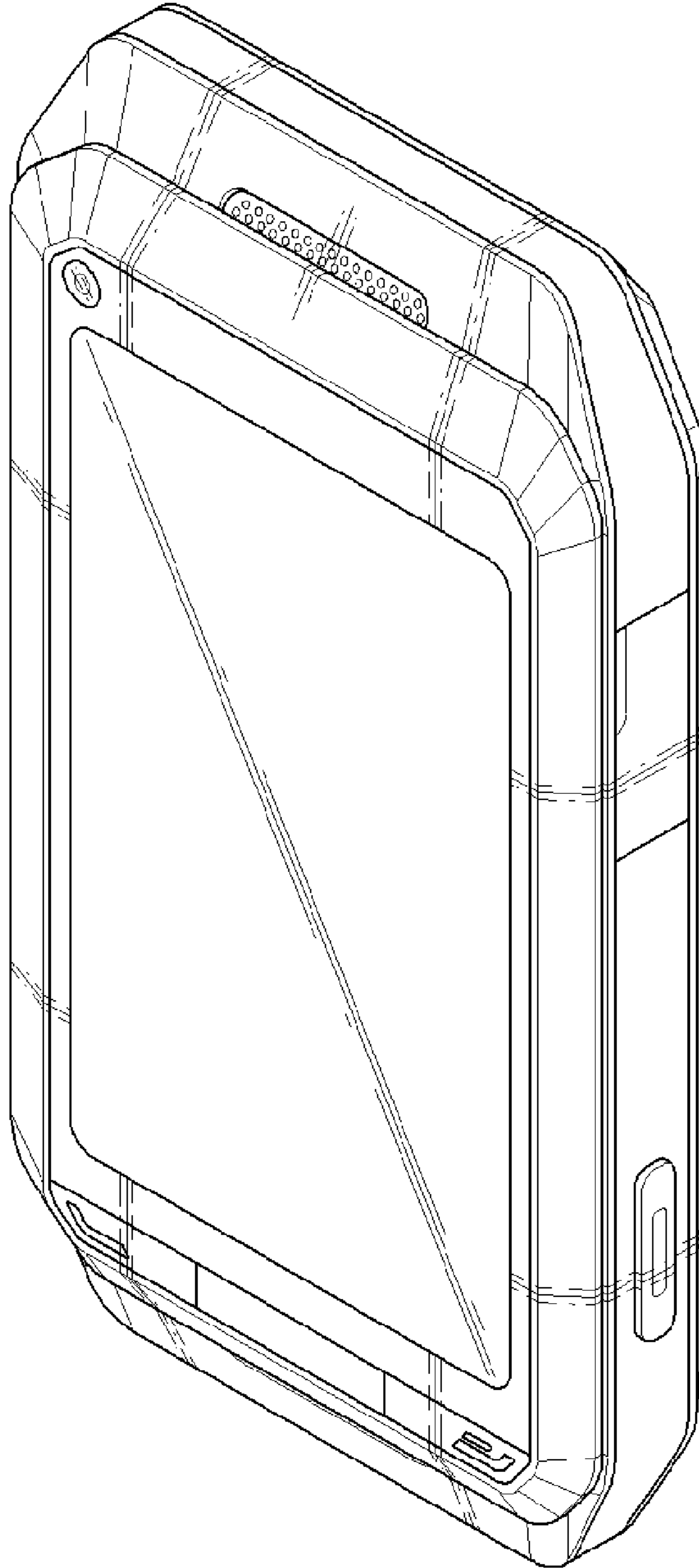

FIG. 2

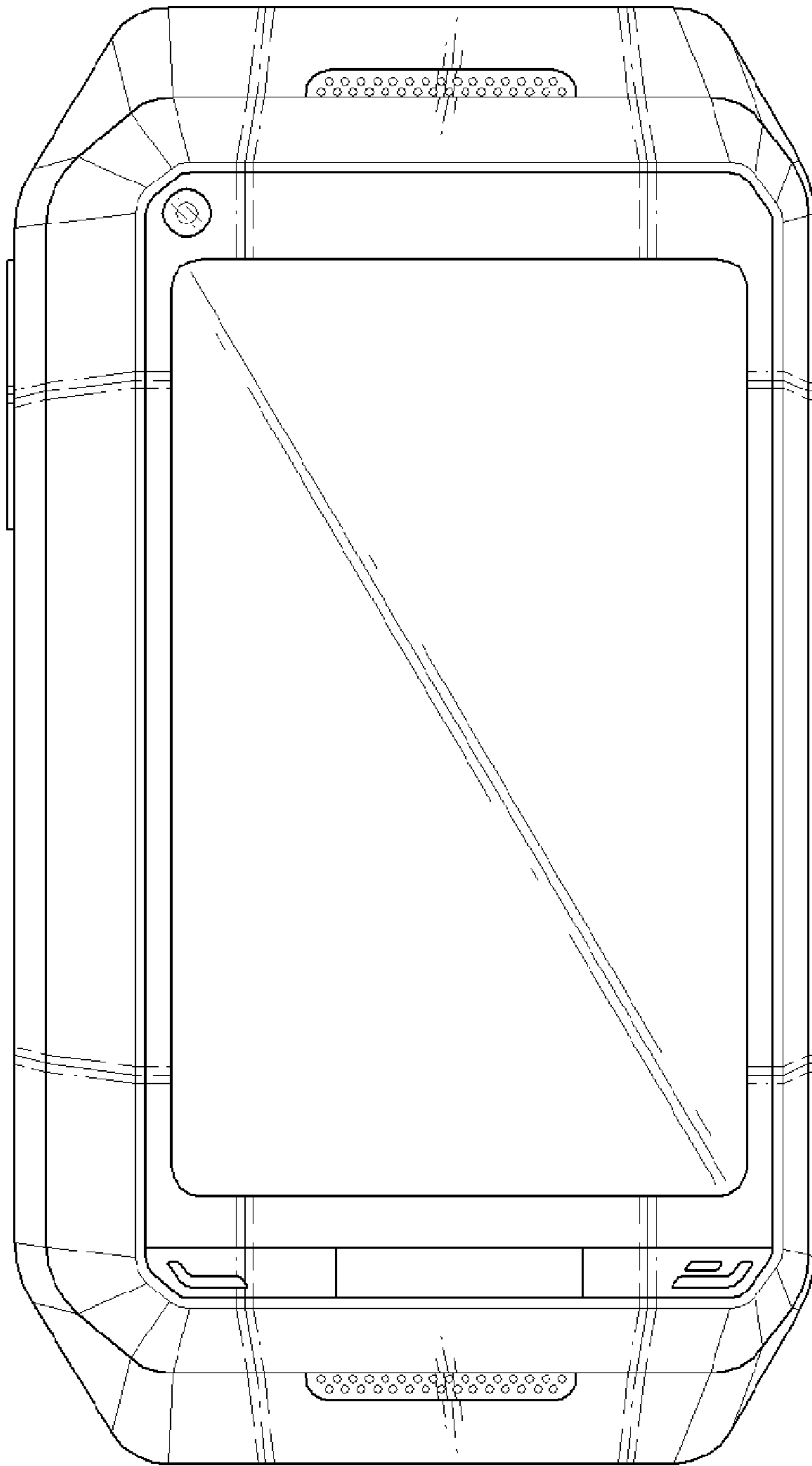

FIG. 3

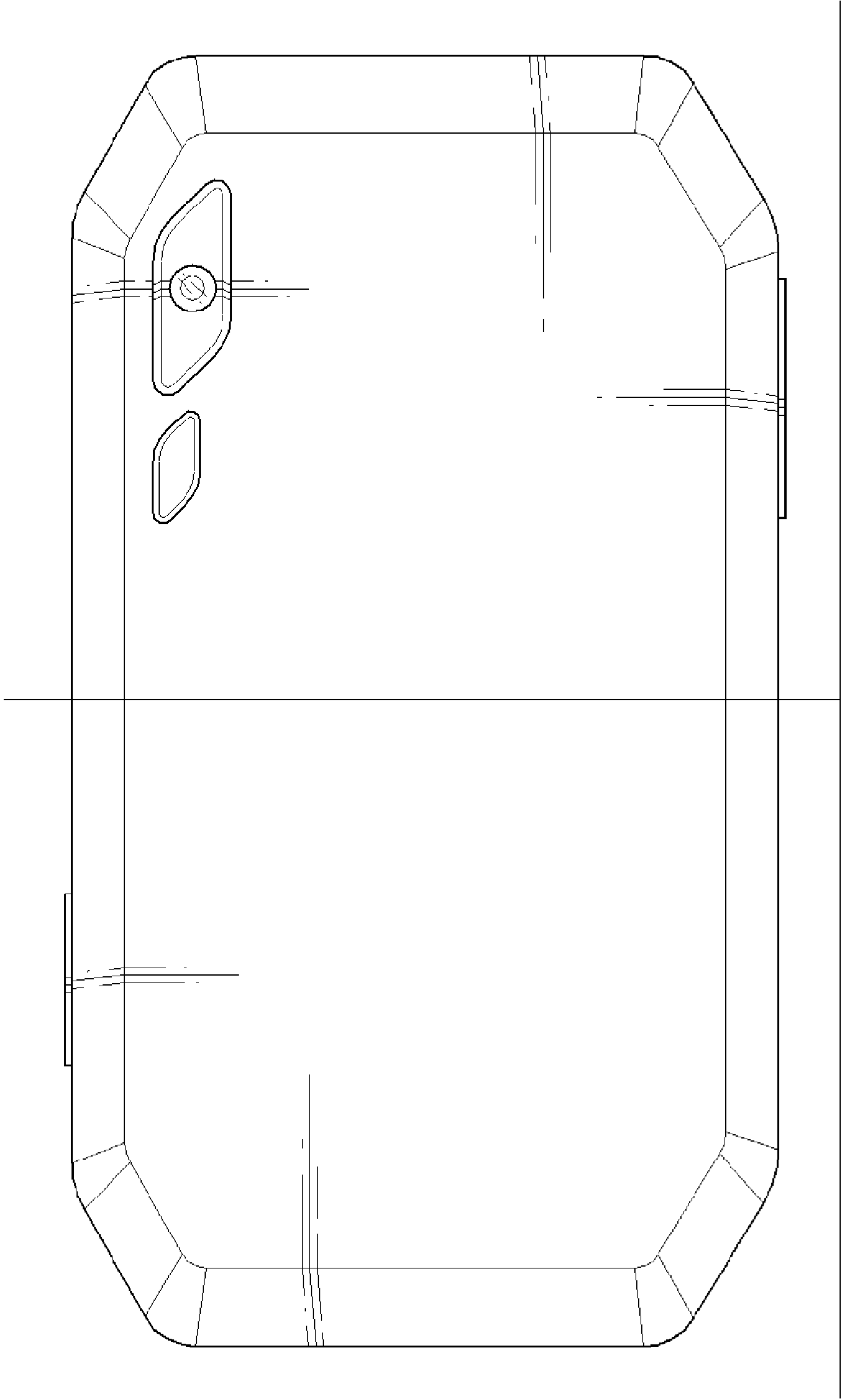

FIG. 4

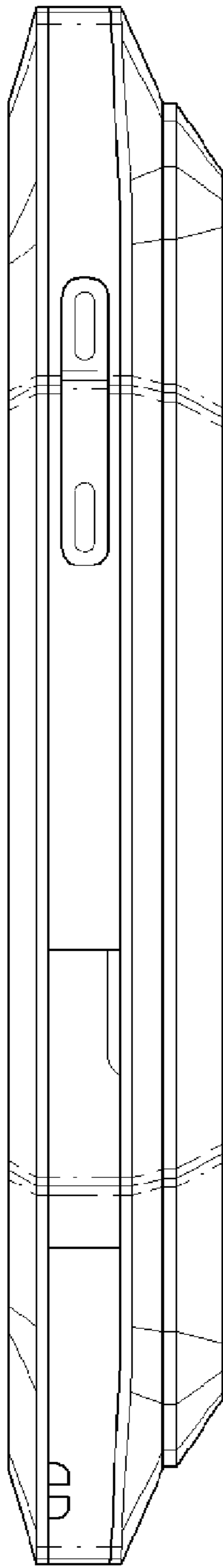

FIG. 5

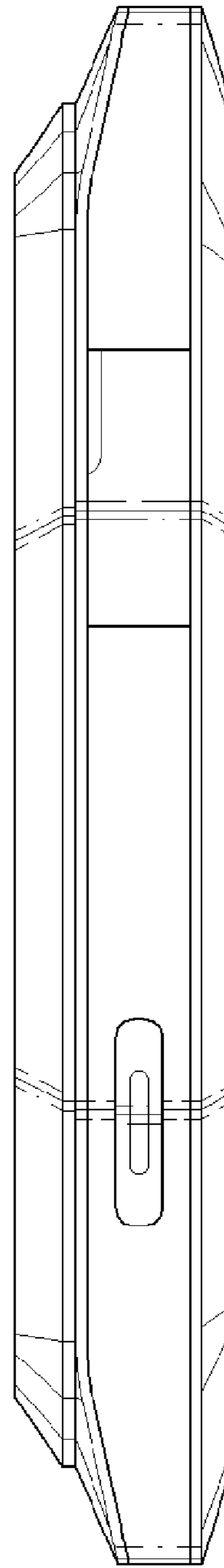

FIG. 6

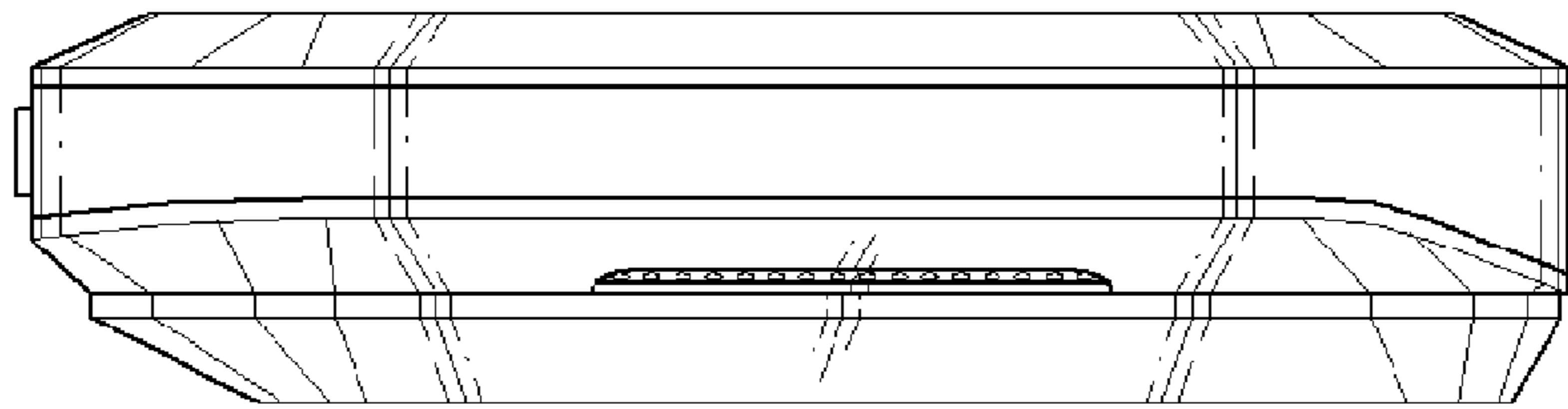

FIG. 7

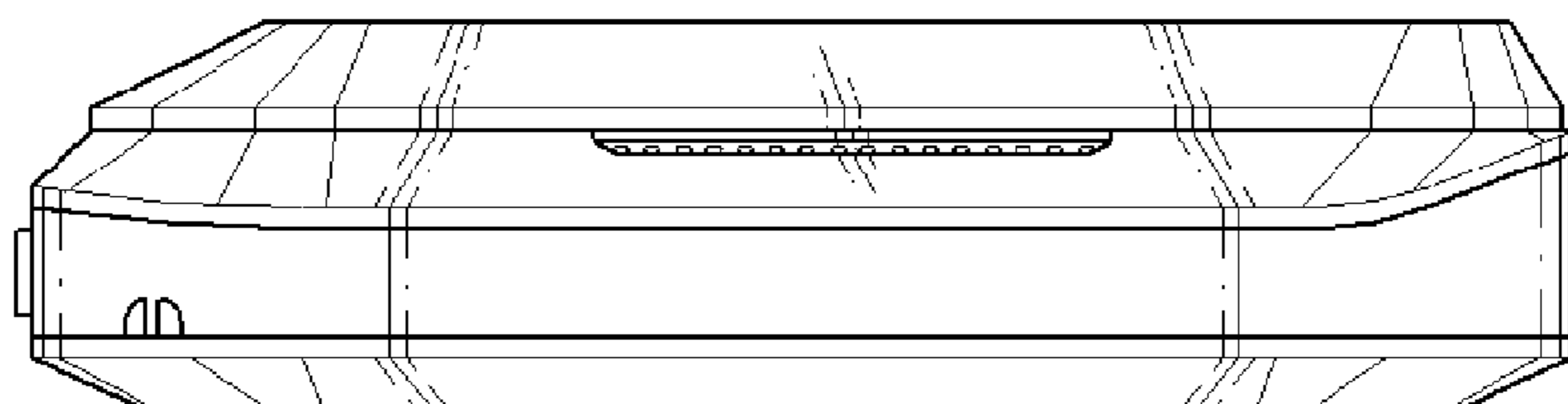
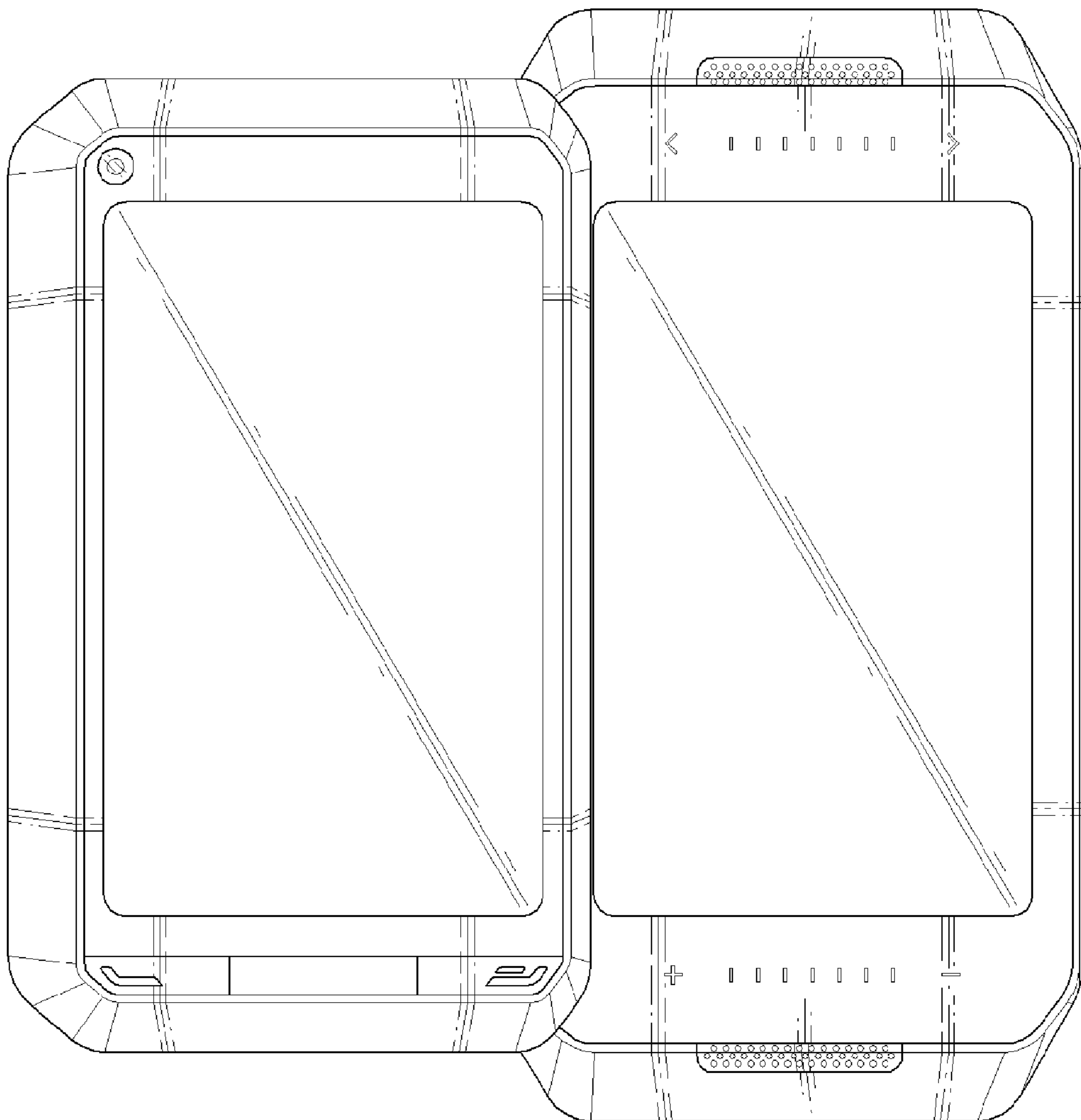

FIG. 8



UNITED STATES PATENT AND TRADEMARK OFFICE
CERTIFICATE OF CORRECTION

PATENT NO. : Des. 622,250 S
APPLICATION NO. : 29/350935
DATED : August 24, 2010
INVENTOR(S) : Kwon et al.

Page 1 of 9

It is certified that error appears in the above-identified patent and that said Letters Patent is hereby corrected as shown below:

The Title Page, showing an illustrative figure, should be deleted and substitute therefor the attached title page.

Please replace all the drawings with new Figures 1-8.

Signed and Sealed this

Twenty-third Day of November, 2010

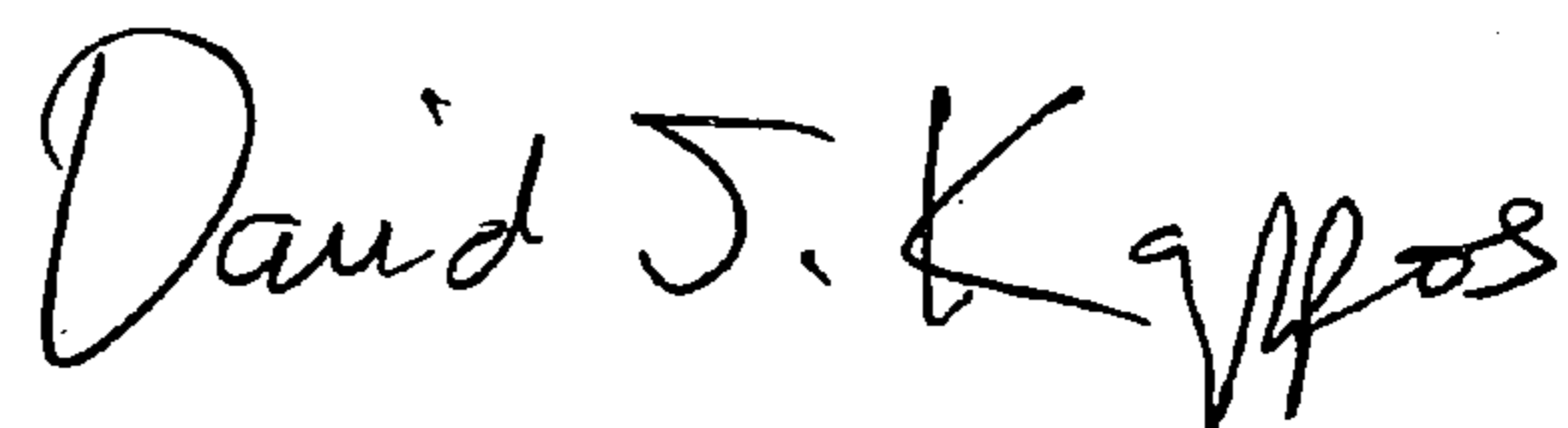

David J. Kappos
Director of the United States Patent and Trademark Office

(12) **United States Design Patent**
Kwon et al.

(10) **Patent No.:** **US D622,250 S**
(45) **Date of Patent:** **** Aug. 24, 2010**

(54) **MOBILE PHONE**

(75) Inventors: **Kyung-Jun Kwon**, Hanam-Si (KR);
Sang-Min Hyun, Seoul (KR); **Nam-Mi Kim**, Seoul (KR)

(73) Assignee: **Samsung Electronics Co., Ltd.**,
Suwon-si (KR)

(**) Term: **14 Years**

(21) Appl. No.: **29/350,935**

(22) Filed: **Nov. 25, 2009**

(30) **Foreign Application Priority Data**

Oct. 15, 2009 (KR) 30-2009-0045441

(51) **LOC (9) Cl.** **14-03**

(52) **U.S. Cl.** **D14/138 G; D14/138 AD**

(58) **Field of Classification Search** D14/138 R,
D14/138 AD, 138 AC, 138 C, 138 G, 191,
D14/203.1-203.8, 496, 138 AA, 138 AB,
D14/247-248, 137, 147, 218, 341-347; D10/65,
D10/78, 104; D13/168; D18/7; 455/566,
455/575.1, 575.3

See application file for complete search history.

(56) **References Cited**

U.S. PATENT DOCUMENTS

D422,972 S * 4/2000 King D14/341
D423,468 S * 4/2000 Jenkins D14/342
D504,120 S * 4/2005 Edoff D14/138 G
D517,038 S * 3/2006 Lee et al. D14/138 AD
7,047,033 B2 * 5/2006 Wyler 455/552.1
D543,193 S * 5/2007 Chung et al. D14/138 AD
D548,713 S * 8/2007 Lee et al. D14/138 AD
D554,635 S * 11/2007 Chung et al. D14/341
D555,137 S * 11/2007 Kim et al. D14/138 AD
7,292,882 B2 * 11/2007 Lee et al. 455/575.4

D563,364 S * 3/2008 Kim et al. D14/138 AB
D571,235 S * 6/2008 Stevens et al. D10/65
D571,798 S * 6/2008 Ogasawara D14/341
D571,799 S * 6/2008 Ogasawara D14/341
D571,800 S * 6/2008 Tamaki et al. D14/345

(Continued)

OTHER PUBLICATIONS

Motorola Sidekick Slide, announced Sep. 2007, [online], [retrieved on May 14, 2008]. Retrieved from Internet ,<URL: <http://www.gsmarena.com>>.*

(Continued)

Primary Examiner—Jeffrey D Asch
Assistant Examiner—Bridget L Eland
(74) *Attorney, Agent, or Firm*—NSIP Law

(57) **CLAIM**

The ornamental design for a mobile phone, as shown and described.

DESCRIPTION

FIG. 1 is a perspective view of a mobile phone;
FIG. 2 is a front view of the mobile phone of FIG. 1;
FIG. 3 is a rear view of the mobile phone of FIG. 1;
FIG. 4 is a left-side view of the mobile phone of FIG. 1;
FIG. 5 is a right-side view of the mobile phone of FIG. 1;
FIG. 6 is a top plan view of the mobile phone of FIG. 1;
FIG. 7 is a bottom plan view of the mobile phone of FIG. 1;
and,
FIG. 8 is a front open view of the mobile phone of FIG. 1.

1 Claim, 6 Drawing Sheets

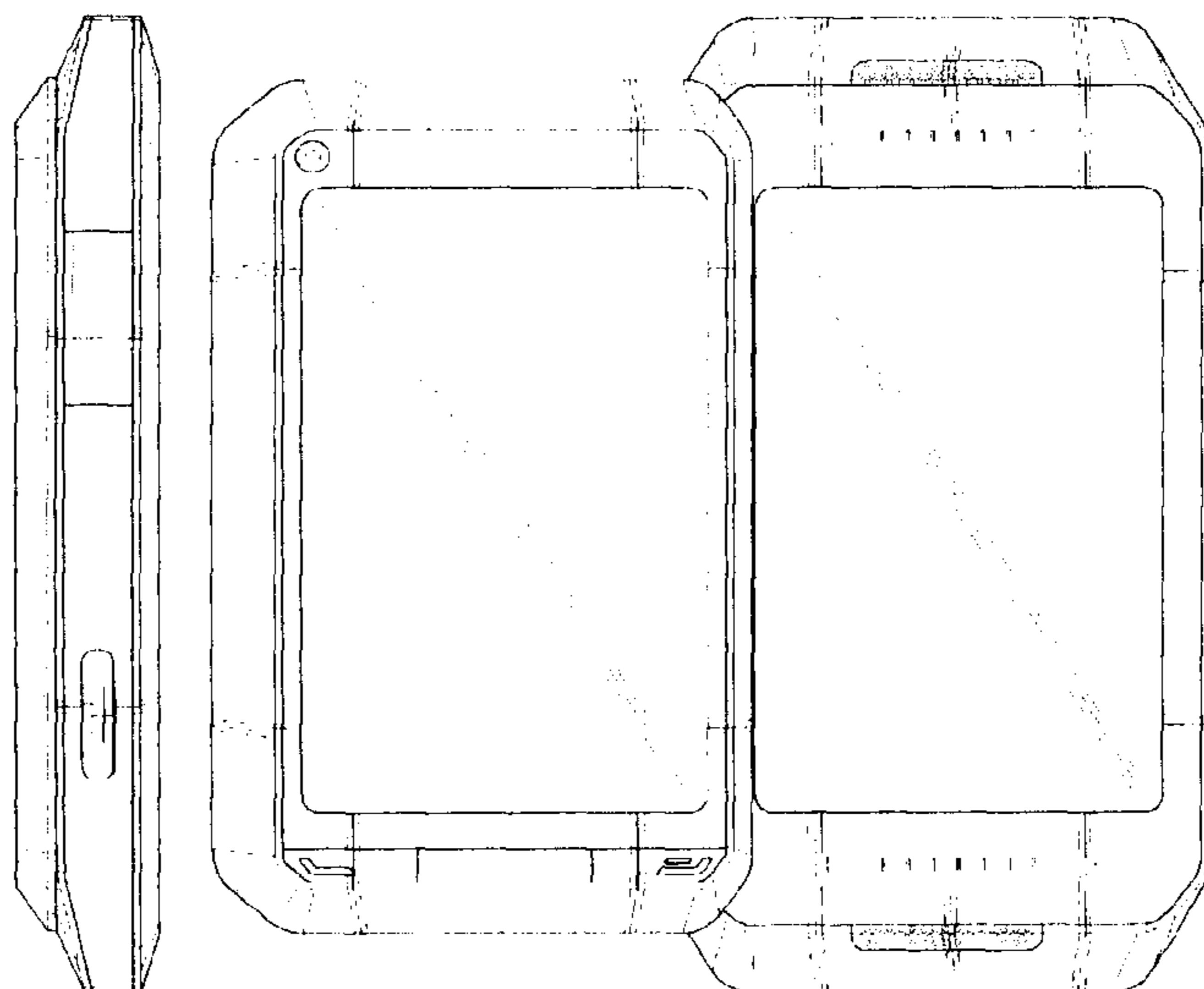

US D622,250 S

Page 2

U.S. PATENT DOCUMENTS

D577,703 S * 9/2008 Lee et al. D14/138 G
 D578,983 S * 10/2008 Bang et al. D14/138 AD
 D580,400 S * 11/2008 Chung et al. D14/138 AD
 D580,401 S * 11/2008 Kim et al. D14/138 AD
 D590,388 S * 4/2009 Price et al. D14/345
 D590,825 S * 4/2009 Liu D14/341
 D604,285 S * 11/2009 Madsen et al. D14/248
 D606,507 S * 12/2009 Kim et al. D14/138 G
 2005/0043063 A1 * 2/2005 Dinn 455/566
 2008/0004085 A1 * 1/2008 Jung et al. 455/566

2008/0297537 A1 * 12/2008 Ishikawa et al. 345/690

OTHER PUBLICATIONS

T-Mobile Sidekick LX 2009, announced Apr. 2009, [online],
 [retrieved on May 1, 2009]. Retrieved from Internet ,<URL: <http://www.gsmarena.com>>.*
 i-mate Ultimate 9502, announced Oct. 2007, [online], [retrieved on
 Dec. 13, 2007]. Retrieved from Internet ,<URL: <http://www.gsmarena.com>>.*
 Pantech Duo, announced Oct. 2007, [online], [retrieved on Jan. 18,
 2008]. Retrieved from Internet ,<URL: <http://www.gsmarena.com>>.*

* cited by examiner

FIG. 1

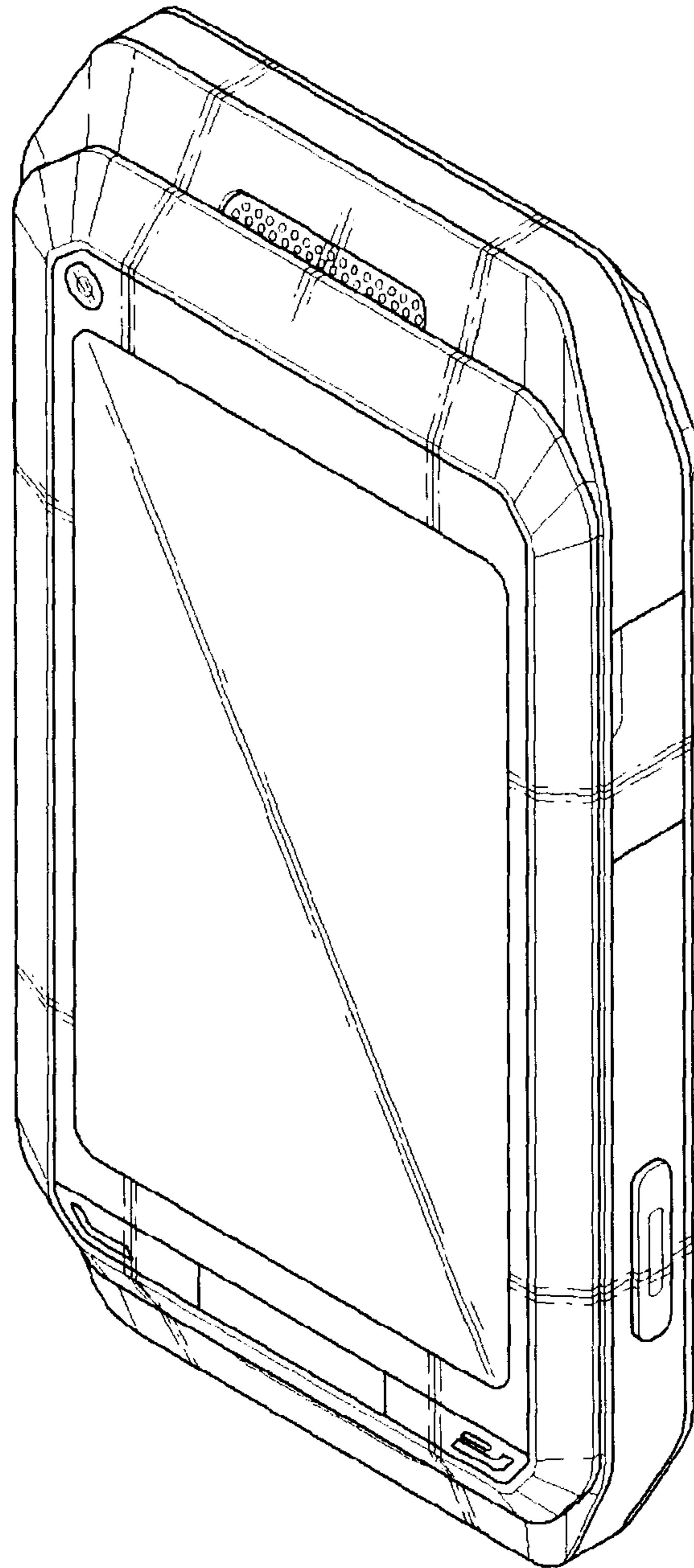

FIG. 2

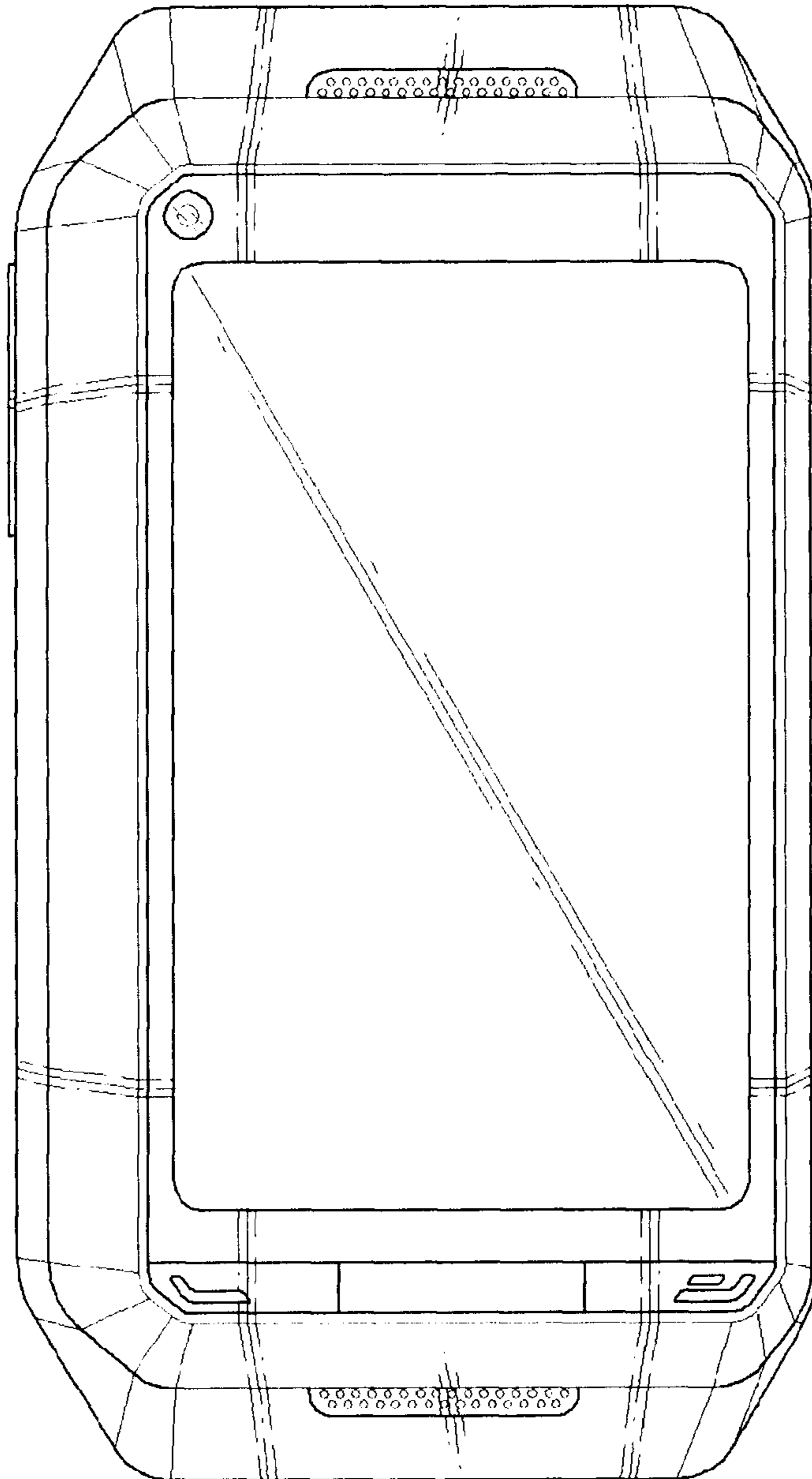

FIG. 3

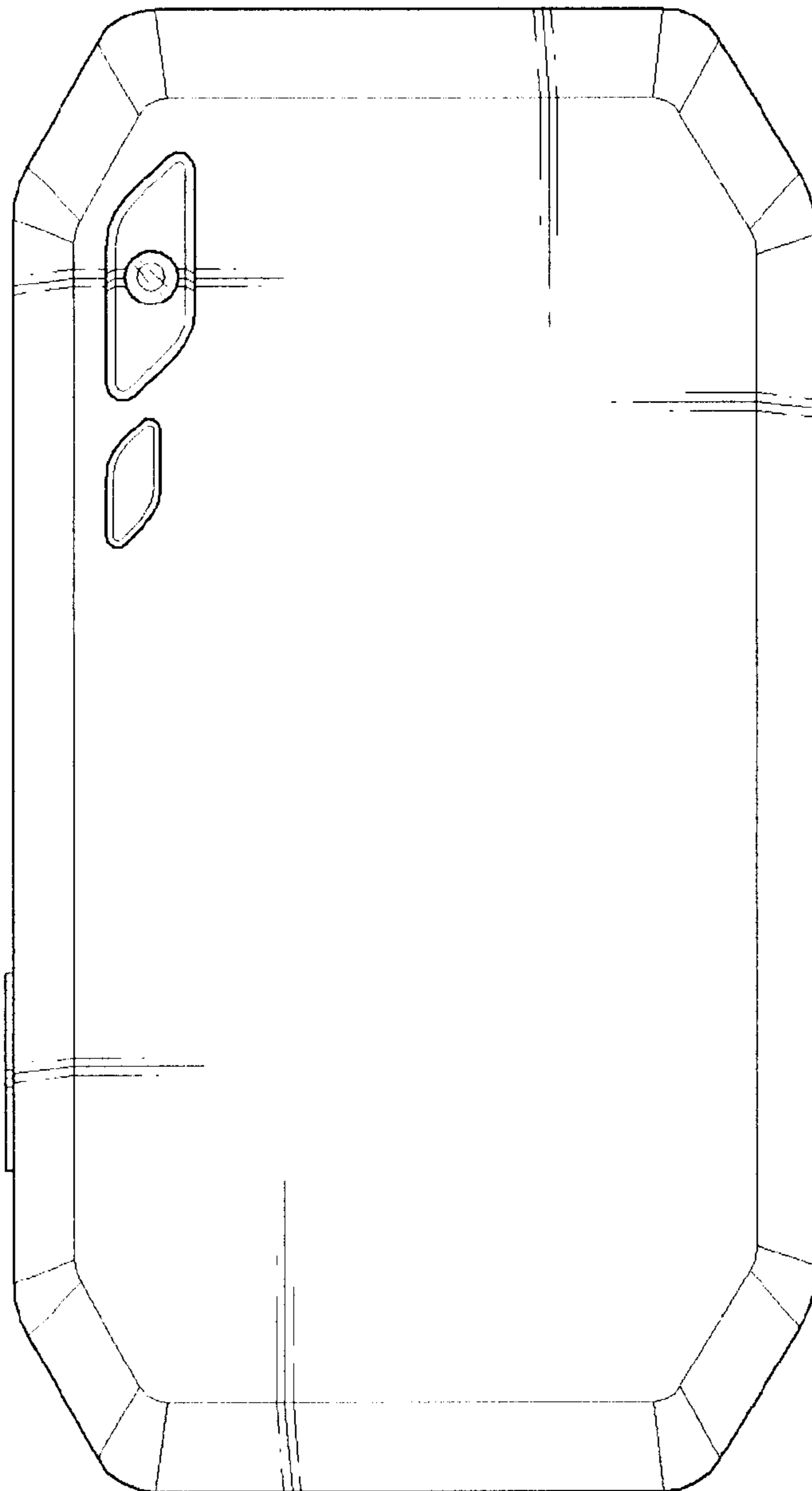

FIG. 4

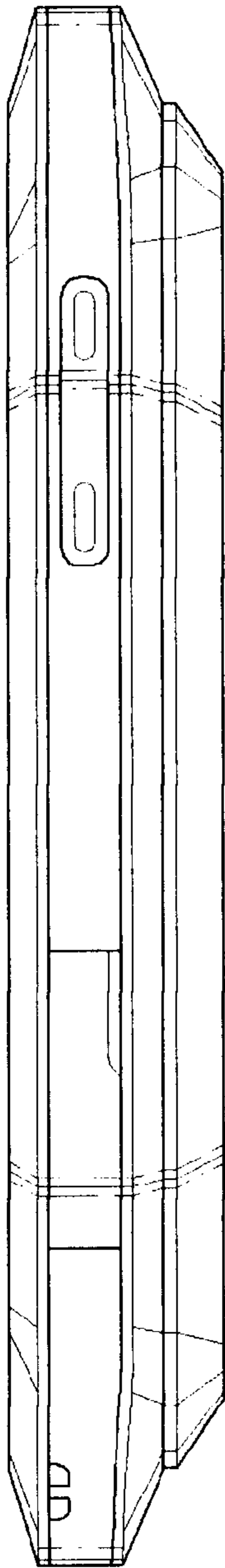

FIG. 5

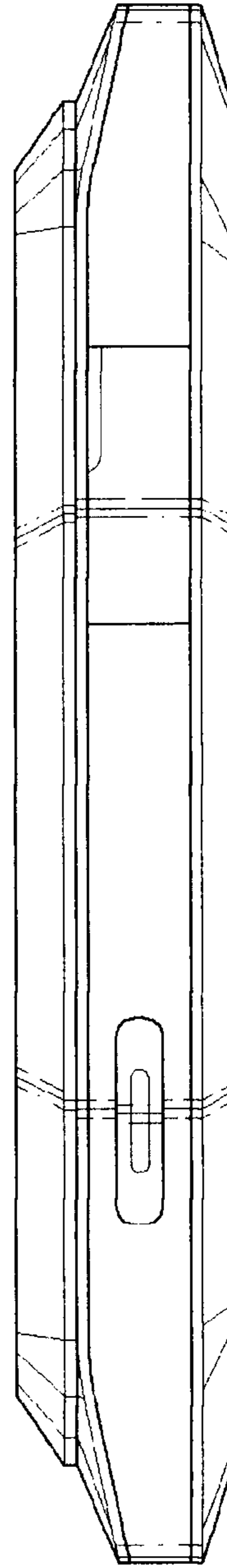

FIG. 6

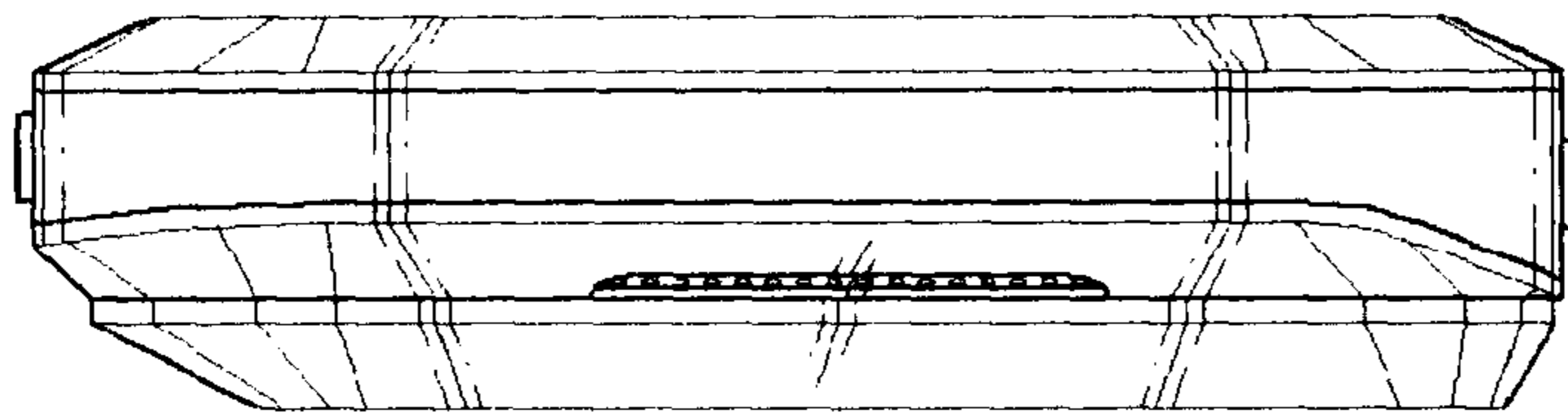

FIG. 7

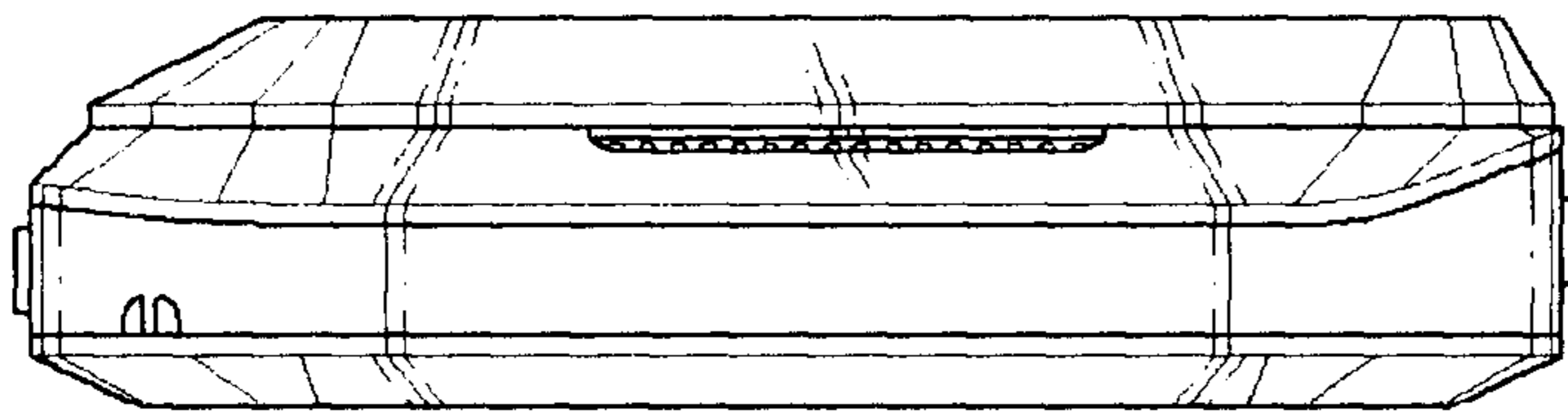

FIG. 8

