



US00D622193S

(12) **United States Design Patent**
Koyama

(10) **Patent No.:** **US D622,193 S**
(45) **Date of Patent:** **** Aug. 24, 2010**

(54) **FRONT BUMPER FOR AN AUTOMOBILE**

(75) Inventor: **Hideo Koyama**, Kariya (JP)
(73) Assignee: **Toyota Jidosha Kabushiki Kaisha** (JP)
(**) Term: **14 Years**
(21) Appl. No.: **29/353,376**
(22) Filed: **Jan. 7, 2010**

(51) **LOC (9) Cl.** **12-16**
(52) **U.S. Cl.** **D12/169**
(58) **Field of Classification Search** D12/169,
D12/196, 171, 163, 216, 90-92, 86; 293/102,
293/113, 115, 117, 120; 296/180.1, 180.2
See application file for complete search history.

(56) **References Cited**

U.S. PATENT DOCUMENTS

D578,451 S * 10/2008 Jodo et al. D12/169
D579,830 S * 11/2008 Ishii D12/169
D604,678 S * 11/2009 Walter et al. D12/169
D610,057 S * 2/2010 Watanabe D12/169

OTHER PUBLICATIONS

Toyota Camry, Brochure of Camry, Toyota, Jan. 2009.
Toyota RAV4, Brochure of RAV4, Toyota, Sep. 2008.

* cited by examiner

Primary Examiner—Melody N Brown

(74) *Attorney, Agent, or Firm*—SAIDMAN DesignLaw Group

(57) **CLAIM**

The ornamental design for a front bumper for an automobile, as shown and described.

DESCRIPTION

FIG. 1 is a front, perspective view of a front bumper for an automobile showing my new design;

FIG. 2 is a front view thereof;

FIG. 3 is a top view thereof;

FIG. 4 is a bottom view thereof;

FIG. 5 is a left-side view thereof; and,

FIG. 6 is a right-side view thereof.

1 Claim, 2 Drawing Sheets

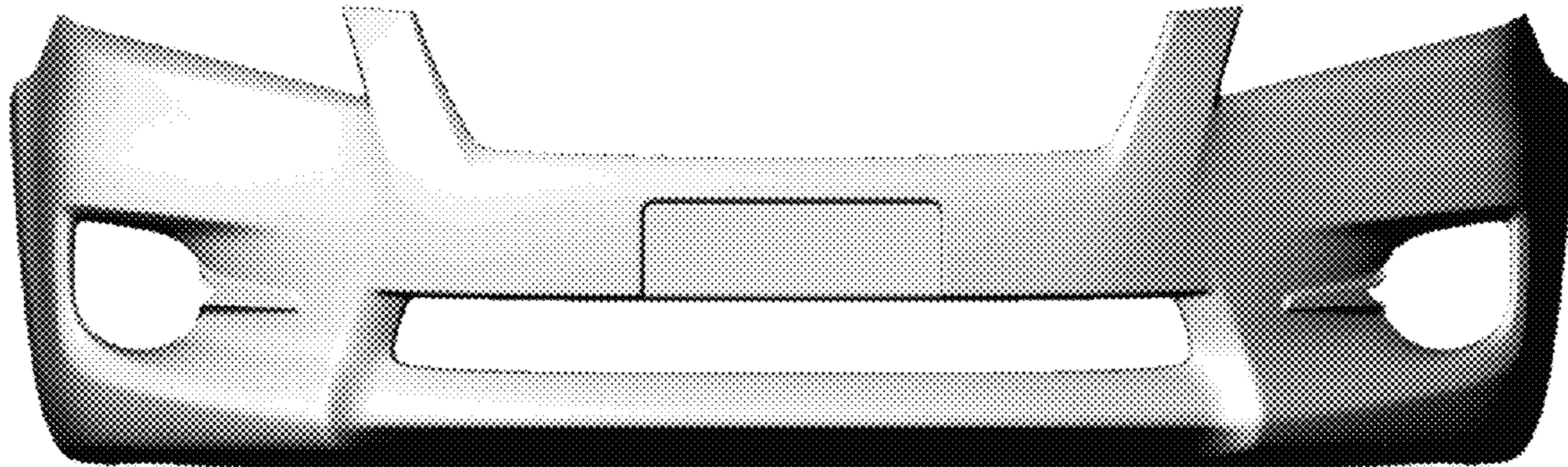

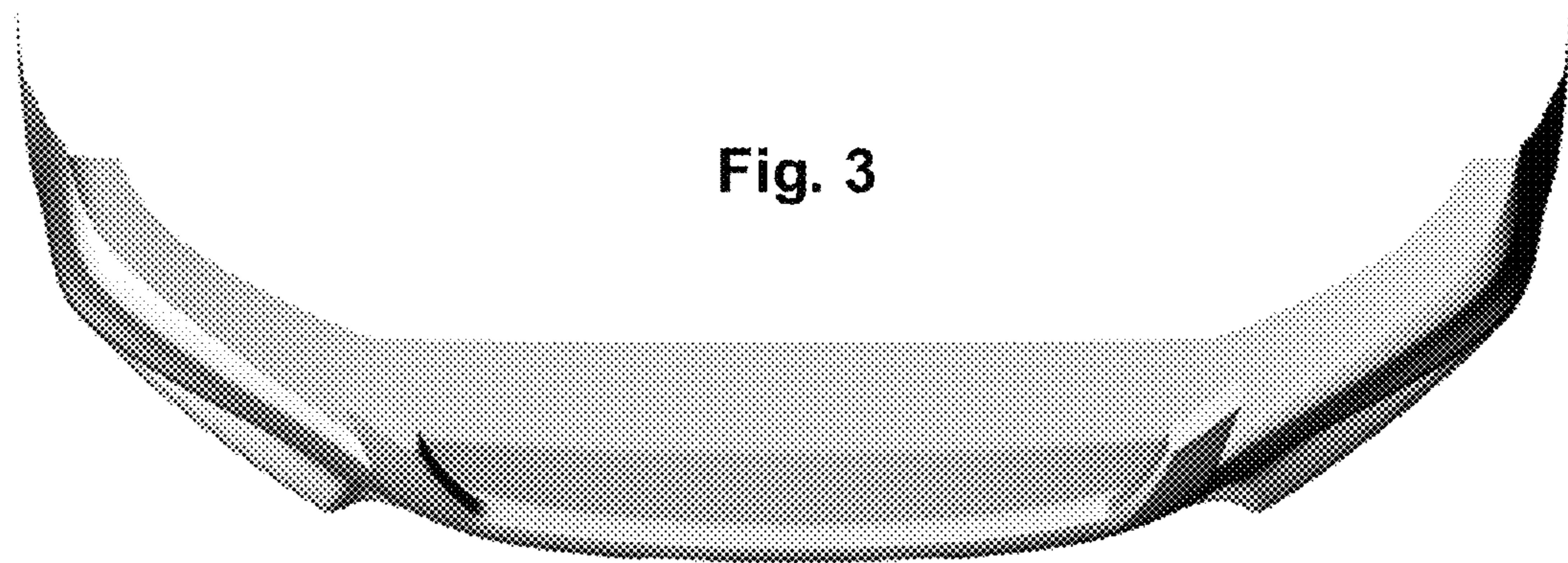
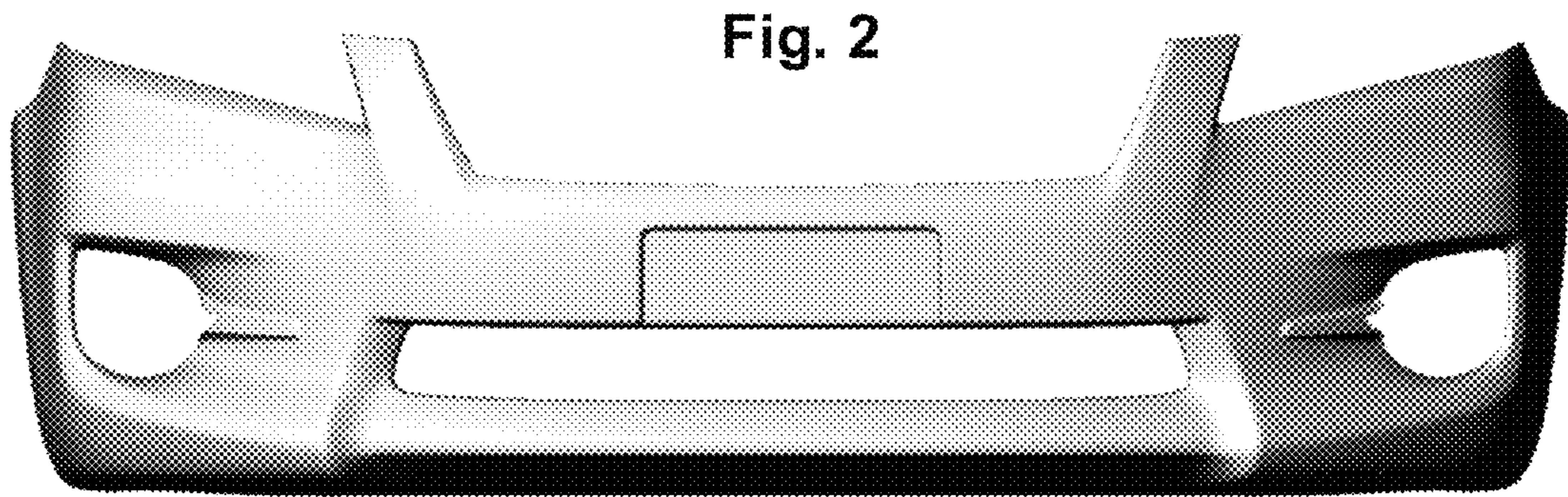
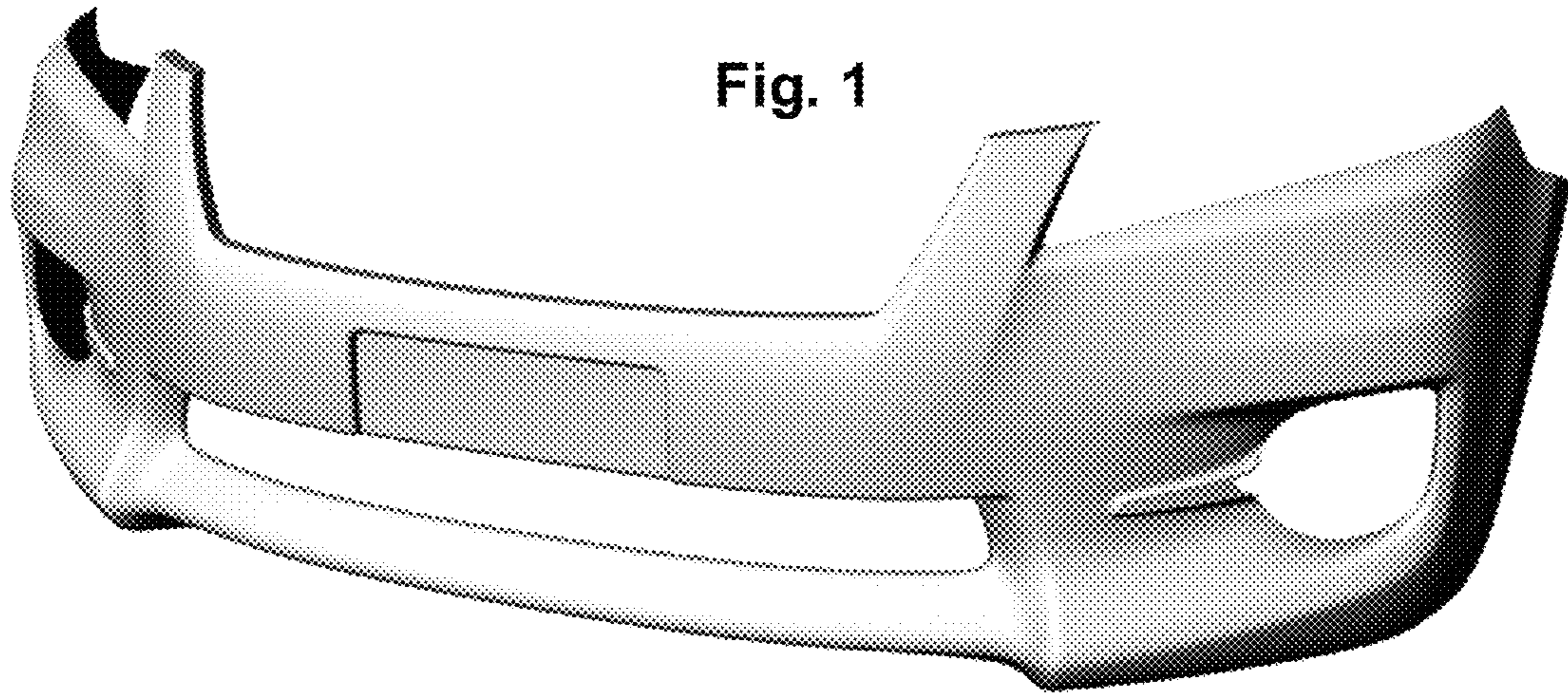

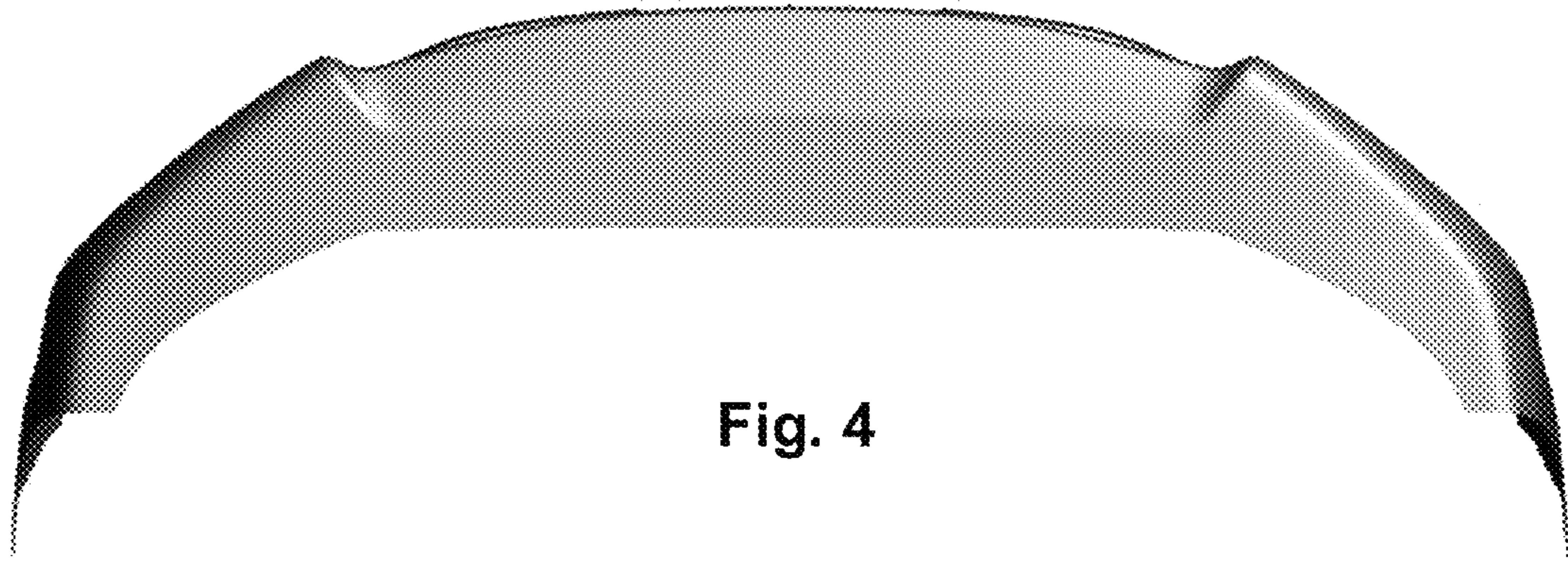

Fig. 4

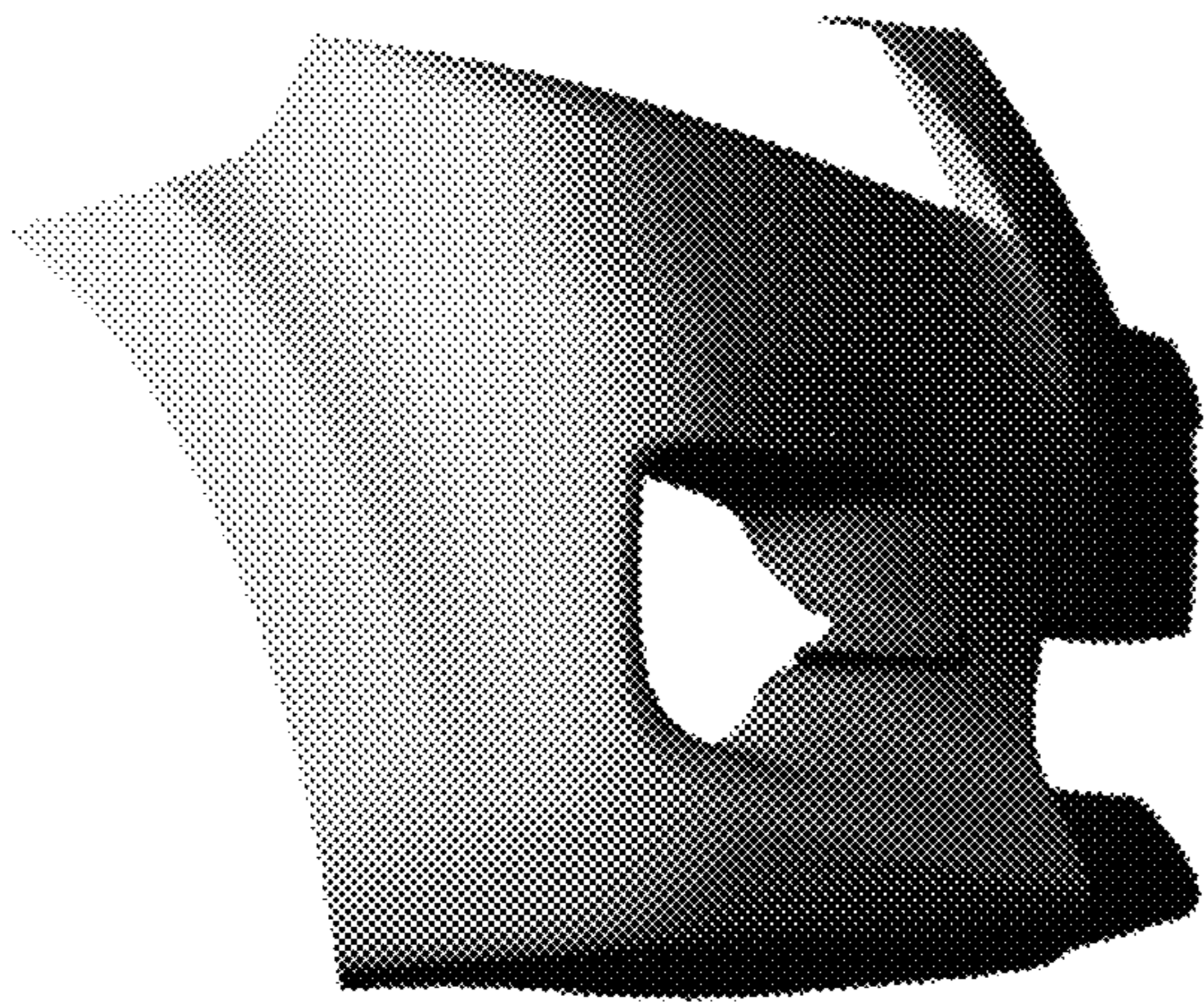

Fig. 5

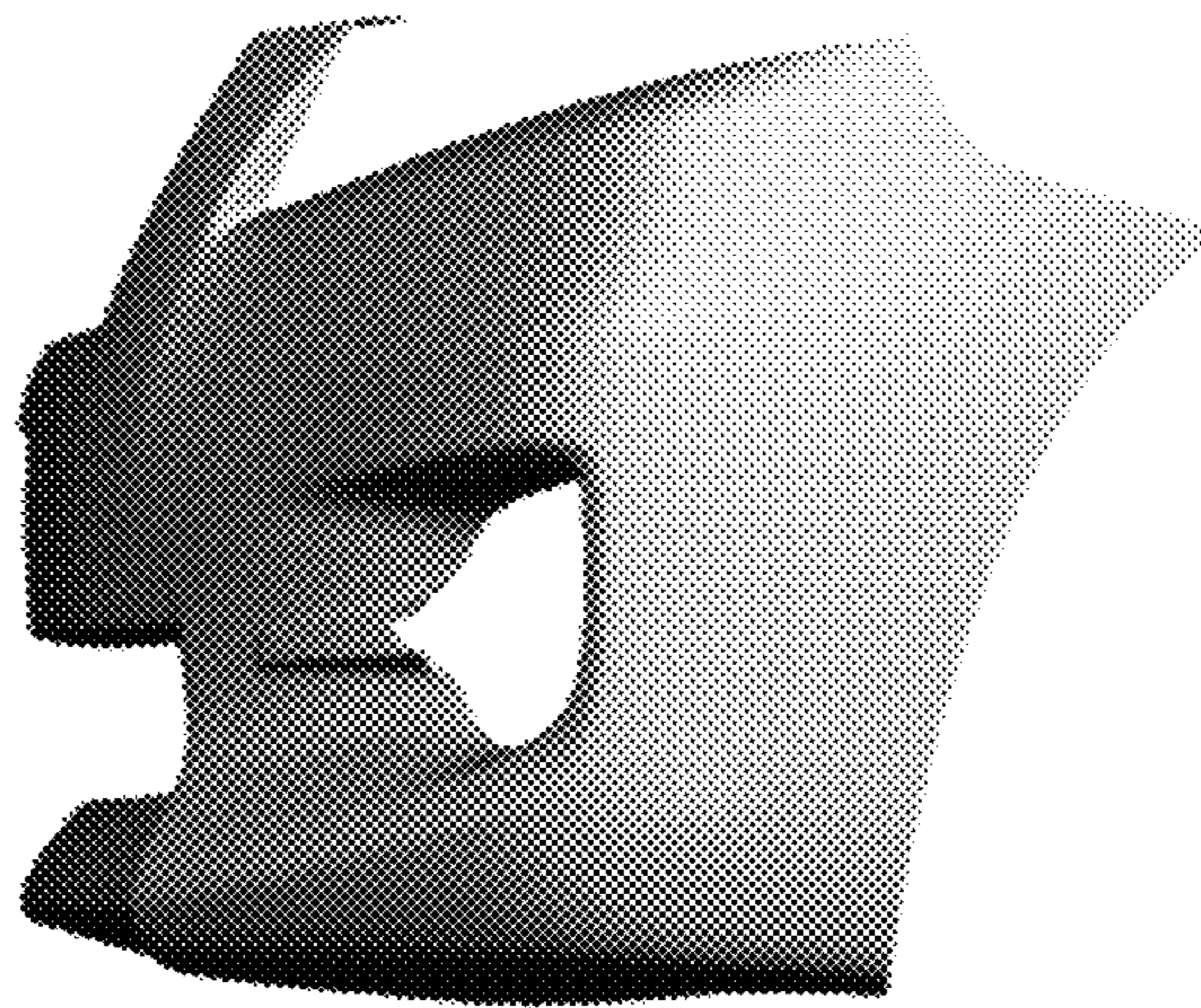

Fig. 6