



US00D622182S

(12) **United States Design Patent**
Parimi et al.

(10) **Patent No.:** **US D622,182 S**

(45) **Date of Patent:** **** Aug. 24, 2010**

(54) **OBJECTIVE GUNNER PROTECTION KIT**

D275,271 S * 8/1984 LeBlanc D12/12
7,478,580 B1 * 1/2009 Parimi et al. 89/36.13

(75) Inventors: **Sanjay Parimi**, Chester, NJ (US);
Thomas J. Kiel, Bernardsville, NJ (US)

(73) Assignee: **The United States of America as
represented by the Secretary of the
Army**, Washington, DC (US)

* cited by examiner

Primary Examiner—T. Chase Nelson
Assistant Examiner—Ania K Dworzecka

(74) *Attorney, Agent, or Firm*—Henry S. Goldfine

(**) Term: **14 Years**

(21) Appl. No.: **29/353,340**

(57) **CLAIM**

(22) Filed: **Jan. 7, 2010**

The ornamental design for an objective gunner protection kit,
as shown and described.

Related U.S. Application Data

(63) Continuation-in-part of application No. 11/682,440,
filed on Mar. 6, 2007, now abandoned.

DESCRIPTION

(51) **LOC (9) Cl.** **23-03**

(52) **U.S. Cl.** **D12/12**

(58) **Field of Classification Search** D12/86–89,
D12/12, 91, 92, 1–4, 98–100; D21/533,
D21/539, 548–552, 557–60, 579, 580–583,
D21/442, 436, 447, 560, 86, 91; 180/232,
180/242, 89.12, 449; 410/57; 89/36.8, 36.09,
89/37.03, 38, 40.03, 36 F, 36 H, 4 B, 36.1,
89/36.13, 36.04, 36.01, 36.02; 446/471,
446/487; 296/181.3, 1.01, 183, 24.1, 37.6,
296/185, 186, 204, 186.1; 280/838, 839

The invention described and claimed herein may be manu-
factured, used, and licensed by or for the U.S. Government for
U.S. Government purposes.

FIG. 1 is a perspective view of a gunner protection enclosure
showing our new design;

FIG. 2 is a second, close-up perspective view thereof;

FIG. 3 is a front elevation view thereof;

FIG. 4. Is a rear elevation view thereof;

FIG. 5 is a left side elevation view thereof;

FIG. 6 is a right side elevation view thereof; and,

FIG. 7 is a top plan view thereof.

The broken lines shown in the Figures depict unclaimed
subject matter only and form no part of the claimed design.

See application file for complete search history.

(56) **References Cited**

U.S. PATENT DOCUMENTS

D275,270 S * 8/1984 LeBlanc D12/12

1 Claim, 6 Drawing Sheets

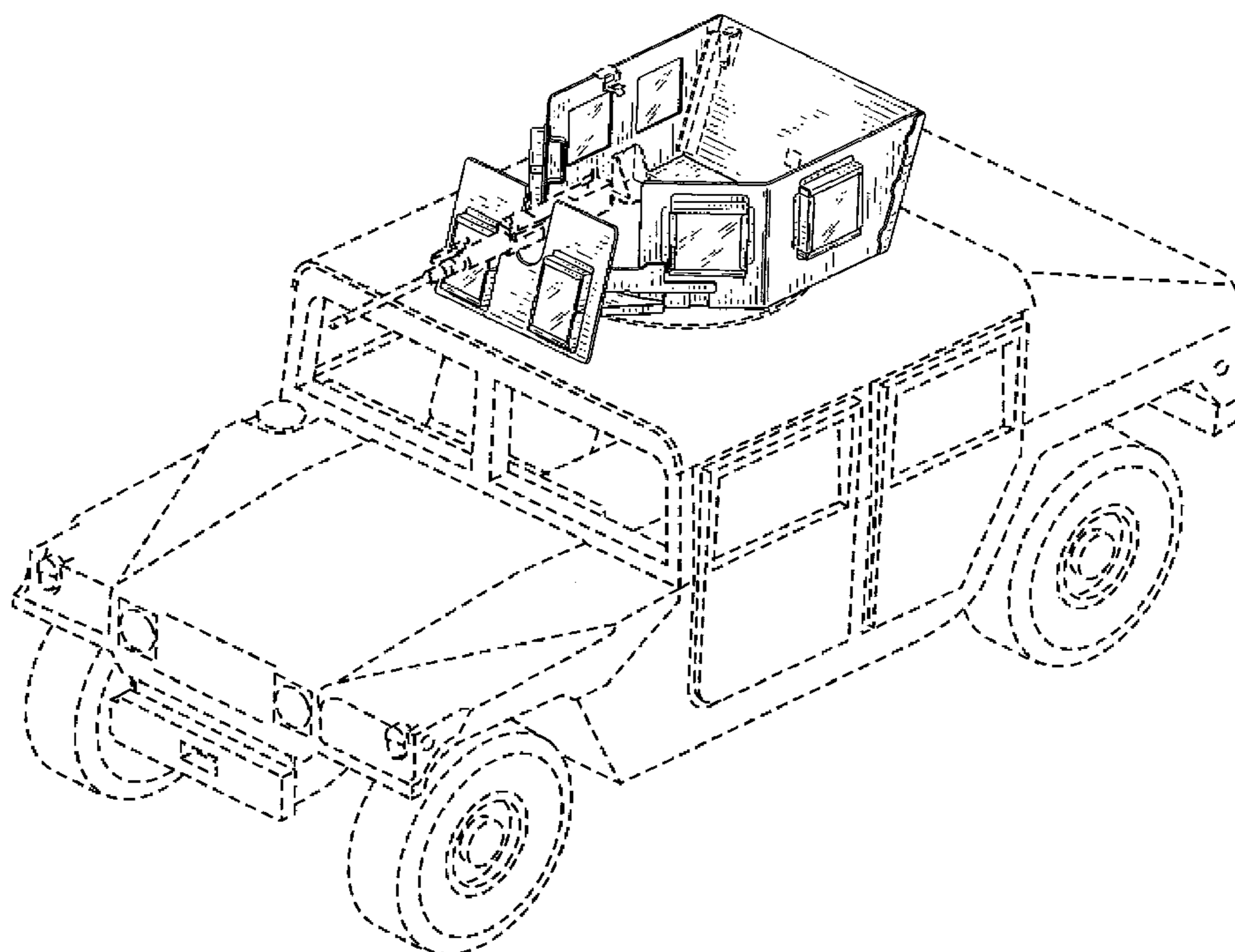

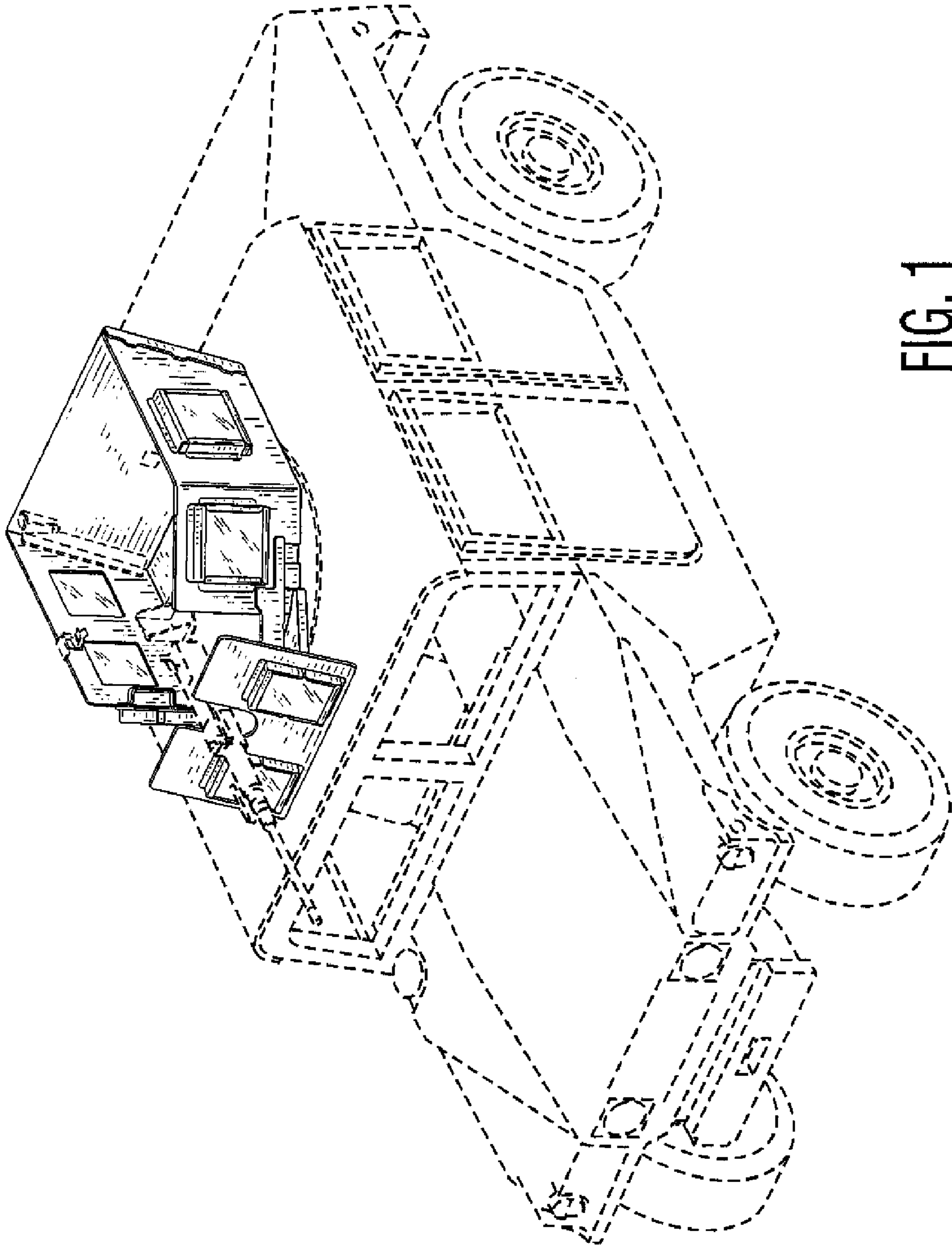

FIG. 1

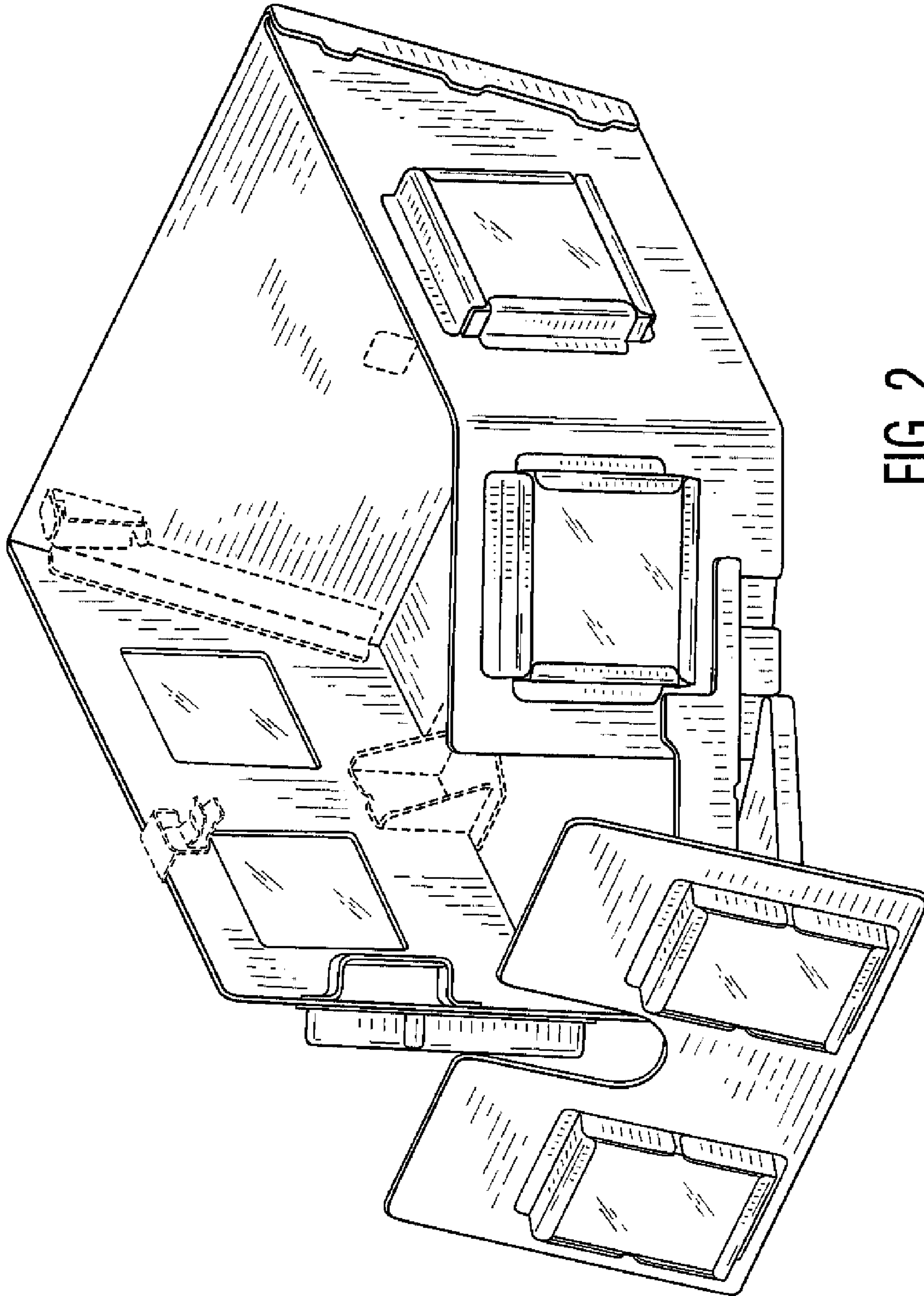

FIG. 2

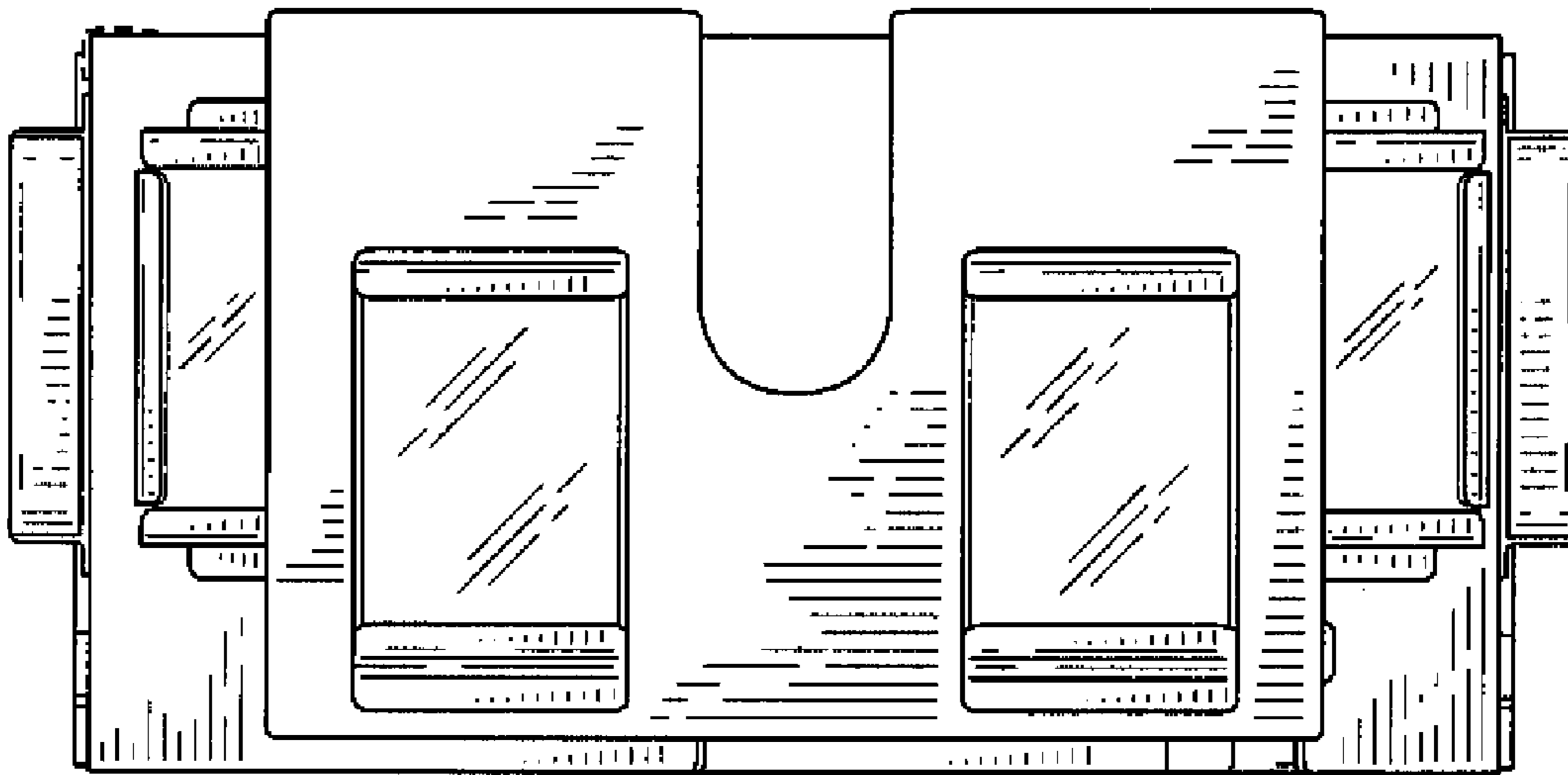

FIG. 3

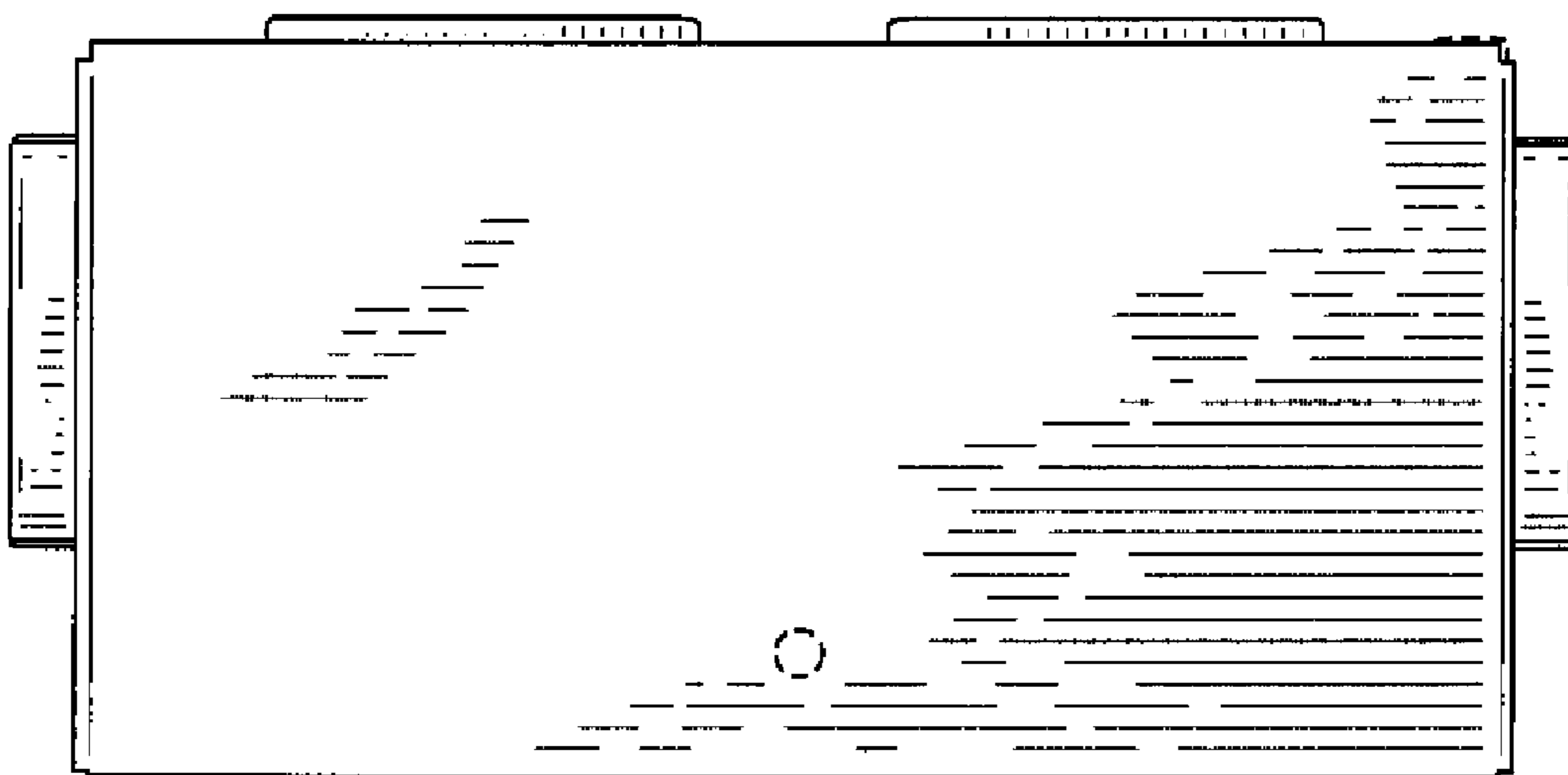

FIG. 4

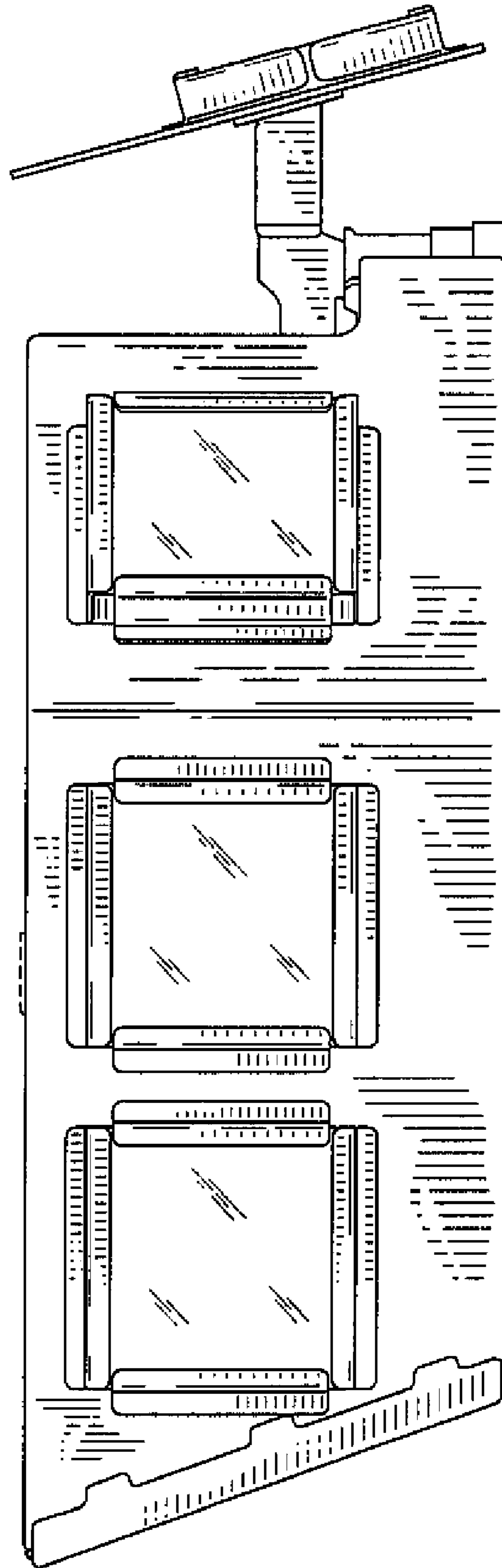

FIG. 5

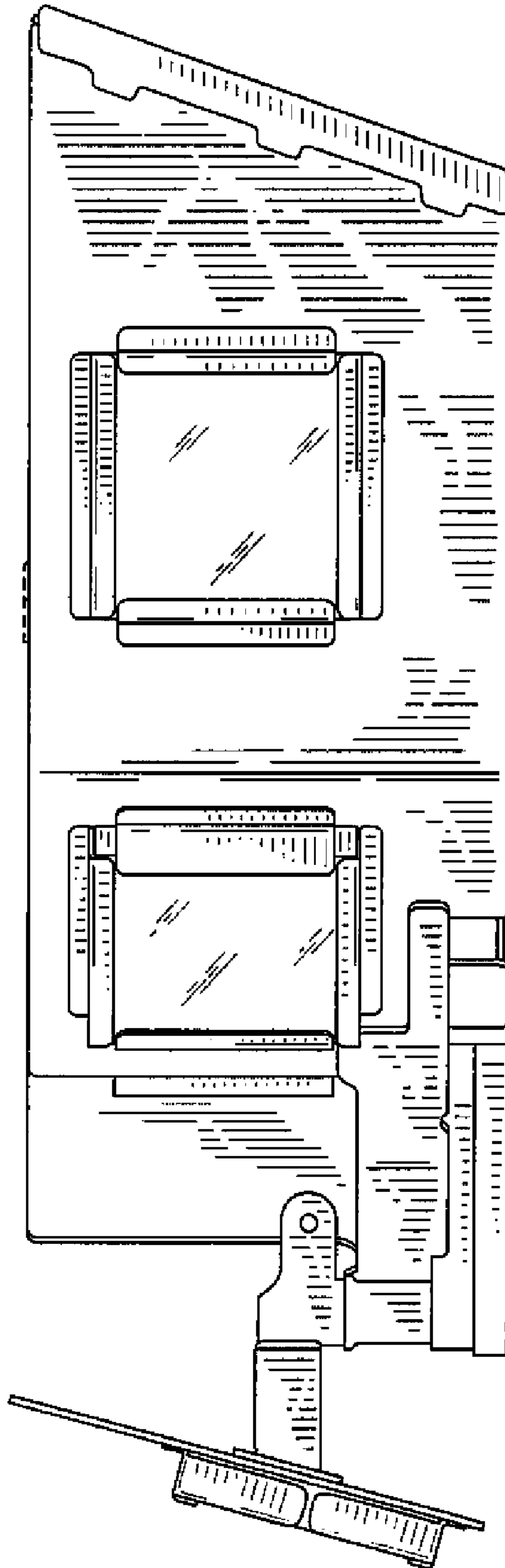

FIG. 6

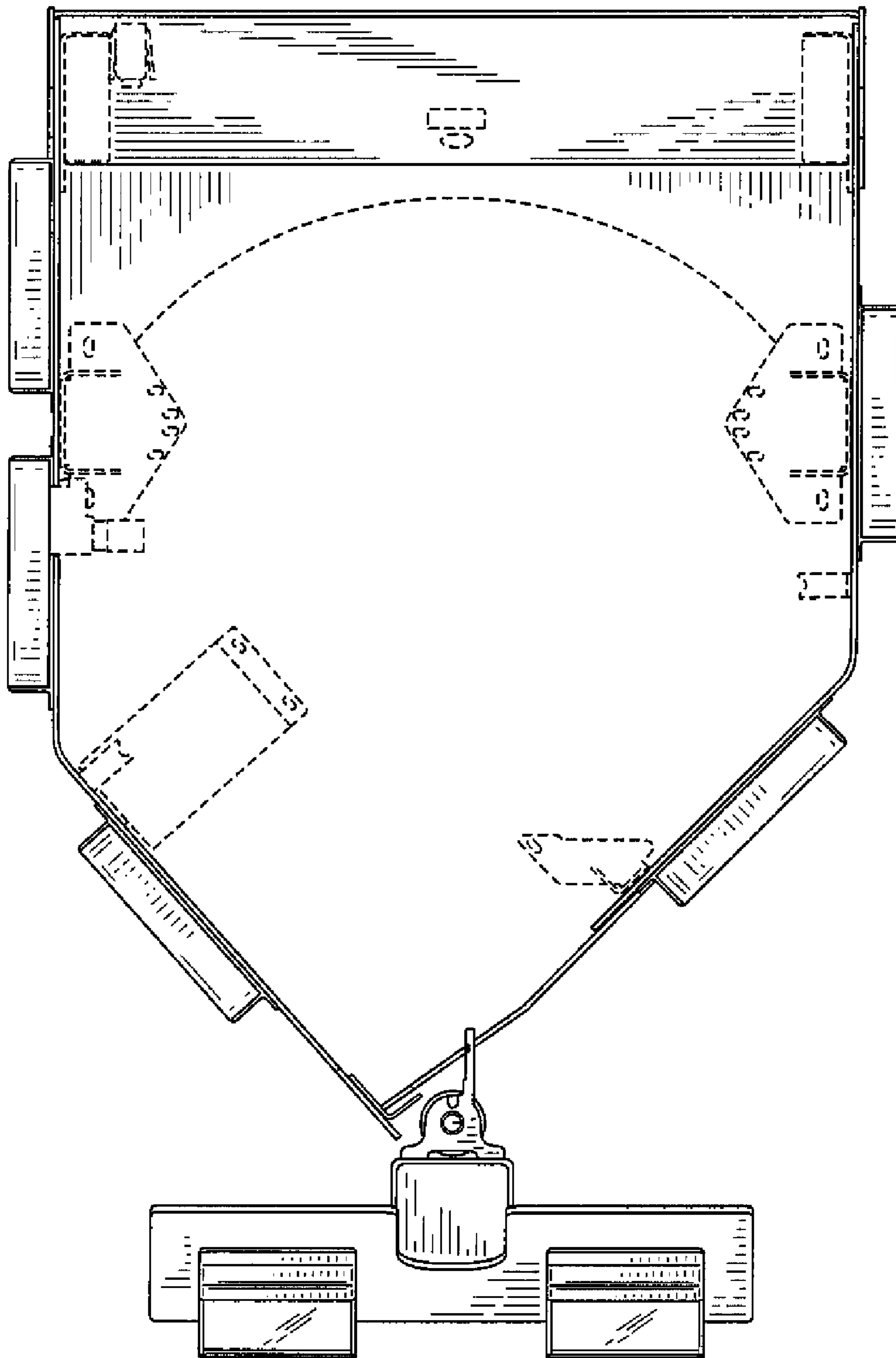

FIG. 7