



US00D622154S

(12) **United States Design Patent**
Vishab

(10) **Patent No.:** **US D622,154 S**

(45) **Date of Patent:** **** Aug. 24, 2010**

(54) **FRAGRANCE BOTTLE AND CAP**

(75) Inventor: **Silke Vishab**, New York, NY (US)

(73) Assignee: **ELC Management LLC**, New York, NY (US)

(**) Term: **14 Years**

(21) Appl. No.: **29/345,031**

(22) Filed: **Oct. 8, 2009**

(51) **LOC (9) Cl.** **09-01**

(52) **U.S. Cl.** **D9/565; D9/454; D9/530**

(58) **Field of Classification Search** D9/434,
D9/435, 454, 516, 520, 529, 530, 545, 549,
D9/550, 551, 552, 563, 564, 565, 571, 574,
D9/575, 682-694; 215/381-385

See application file for complete search history.

(56) **References Cited**

U.S. PATENT DOCUMENTS

D29,092 S *	7/1898	Freeman	D9/558
D92,843 S *	7/1934	Gest	D24/110
D99,648 S *	5/1936	Muhlens	D9/545
D143,656 S *	1/1946	Graham	D9/544
D220,253 S *	3/1971	Fernandez	D9/519
D278,411 S *	4/1985	Reitzel et al.	D9/529
D290,687 S *	7/1987	Llorente	D9/529
D304,688 S *	11/1989	Miyakawa	D9/566
D316,969 S	5/1991	Wiseman et al.		
D324,998 S	3/1992	Klapwald		
D332,913 S *	2/1993	Carroll	D9/694
D346,746 S	5/1994	Desgrippes		
D354,001 S	1/1995	Park		
D356,263 S	3/1995	Matsumoto		
D357,416 S	4/1995	Valentine		
D378,354 S *	3/1997	Varlet	D9/544
D395,604 S *	6/1998	Lecoule	D9/522
D398,243 S *	9/1998	Dinand	D9/548
D407,320 S *	3/1999	Costen et al.	D9/564
D443,505 S *	6/2001	Finocchiaro et al.	D9/696
D452,827 S *	1/2002	Cointreau	D9/564

D471,086 S *	3/2003	Helleu	D9/694
D476,900 S	7/2003	Katz et al.		
D541,663 S *	5/2007	Sorensen et al.	D9/558
D546,692 S *	7/2007	Verburg	D9/526
D550,095 S *	9/2007	De Oliveira Neto	D9/564
D570,704 S *	6/2008	Boudard	D9/682
D590,269 S *	4/2009	Pavone	D9/572
D592,973 S	5/2009	Kim		
D610,916 S *	3/2010	Yeung et al.	D9/694

OTHER PUBLICATIONS

Mintel gnpd; <http://www.gnpd.com>; Cologne Spray; Record ID: 1090283; Disney boom'; Disney Hannah Montana Ready to Rock; Fragrances; Women's Fragrances; Canada; May 2009.

Mintel gnpd; <http://www.gnpd.com>; Eau de Toilette; Record ID: 1071469; Avon; Avon Wish of Luck; Fragrances; Women's Fragrances; USA; Mar. 2009.

* cited by examiner

Primary Examiner—Stella M Reid

Assistant Examiner—Elizabeth J Oswecki

(74) *Attorney, Agent, or Firm*—Cynthia R. Miller

(57) **CLAIM**

The ornamental design for a fragrance bottle and cap, substantially as shown and described.

DESCRIPTION

FIG. 1 is a top, front, right side perspective view of a fragrance bottle and cap showing my new design;

FIG. 2 is a front elevational view thereof;

FIG. 3 is a rear elevational view thereof;

FIG. 4 is a right side elevational view thereof;

FIG. 5 is a left side elevational view thereof;

FIG. 6 is a top plan view thereof; and,

FIG. 7 is a bottom plan view thereof.

The portions of the bottle shown in broken lines in FIGS. 6 and 7 of the drawings form no part of the claimed design.

1 Claim, 3 Drawing Sheets

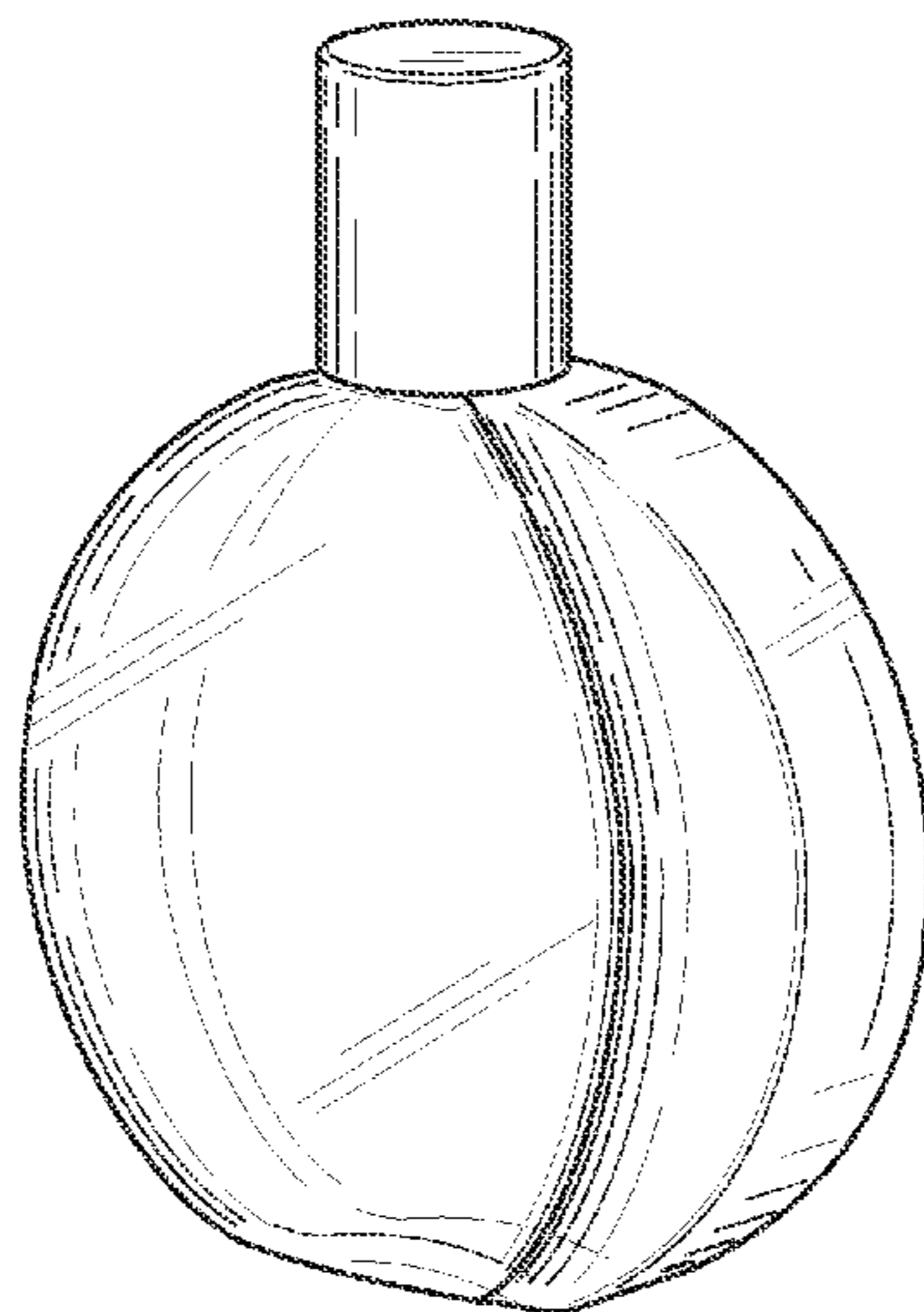

FIG. 1

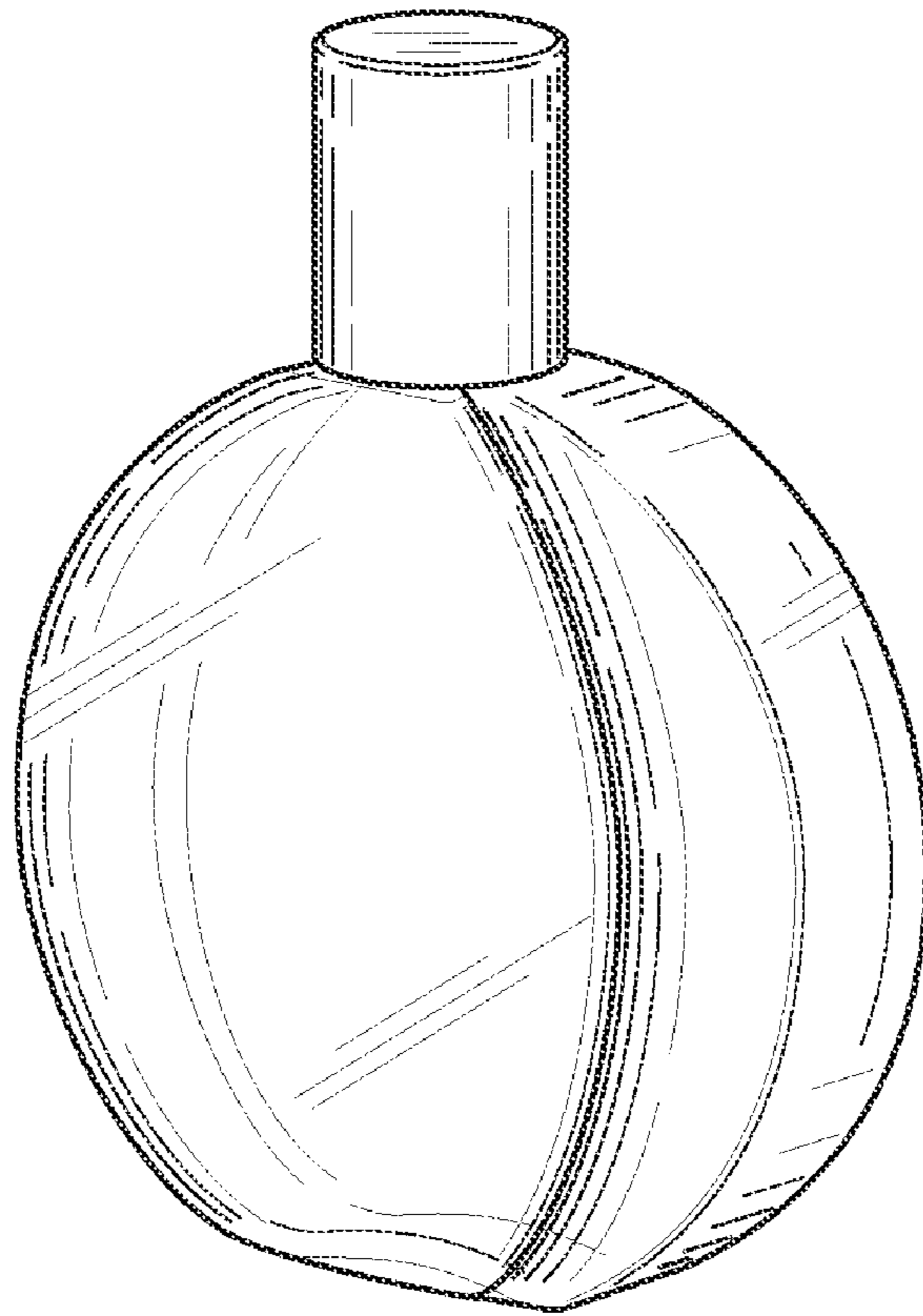

FIG. 2

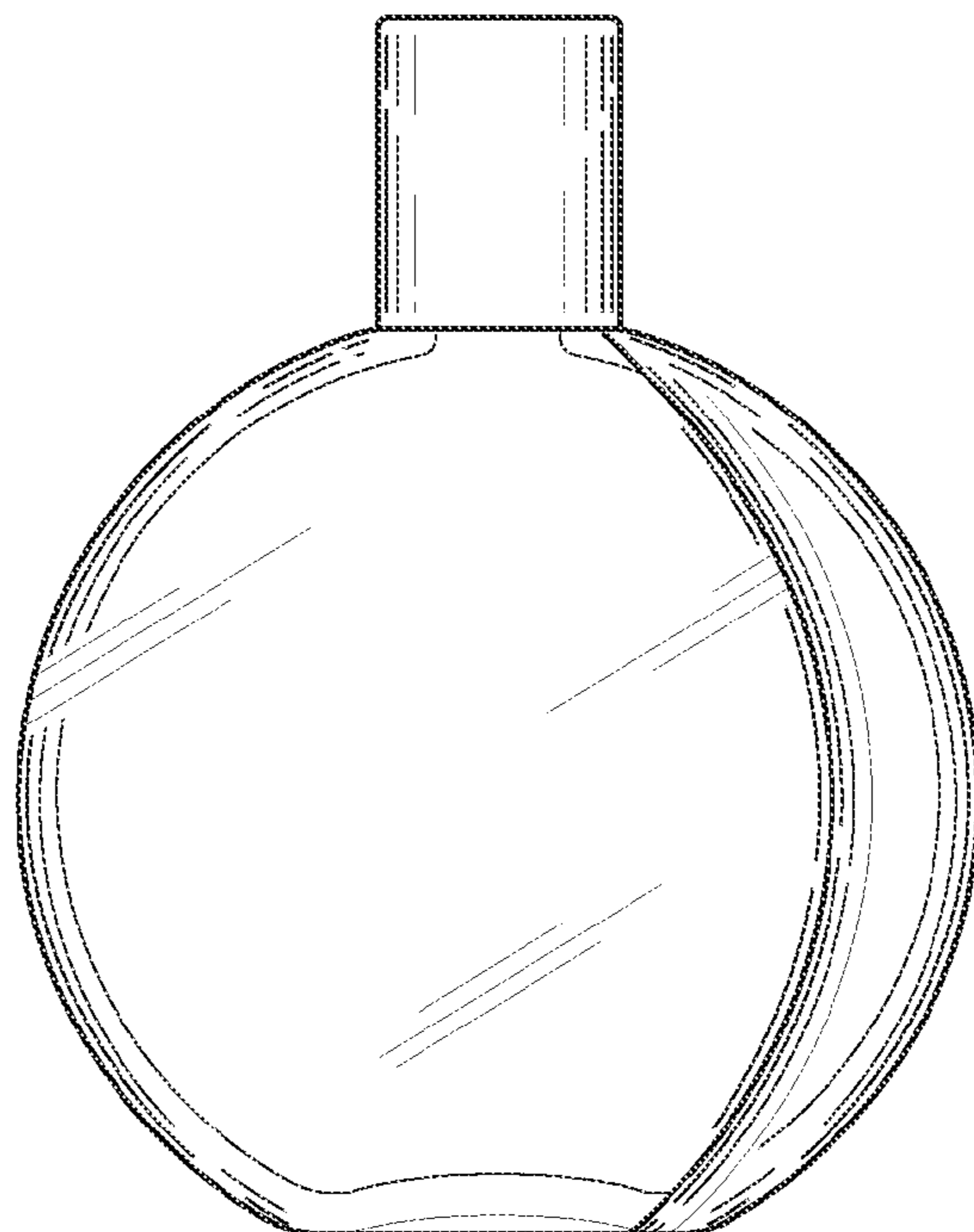

FIG. 3

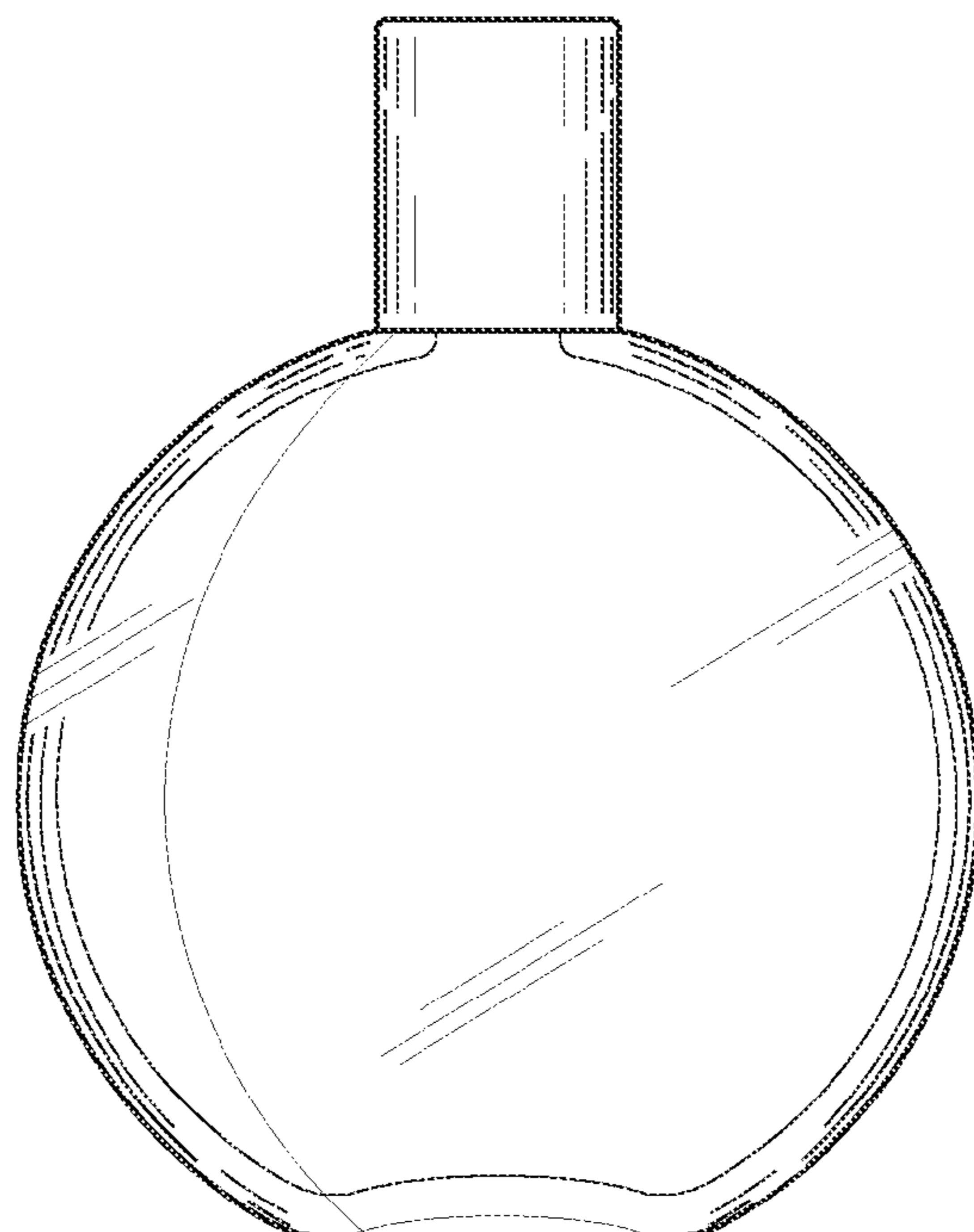

FIG. 4

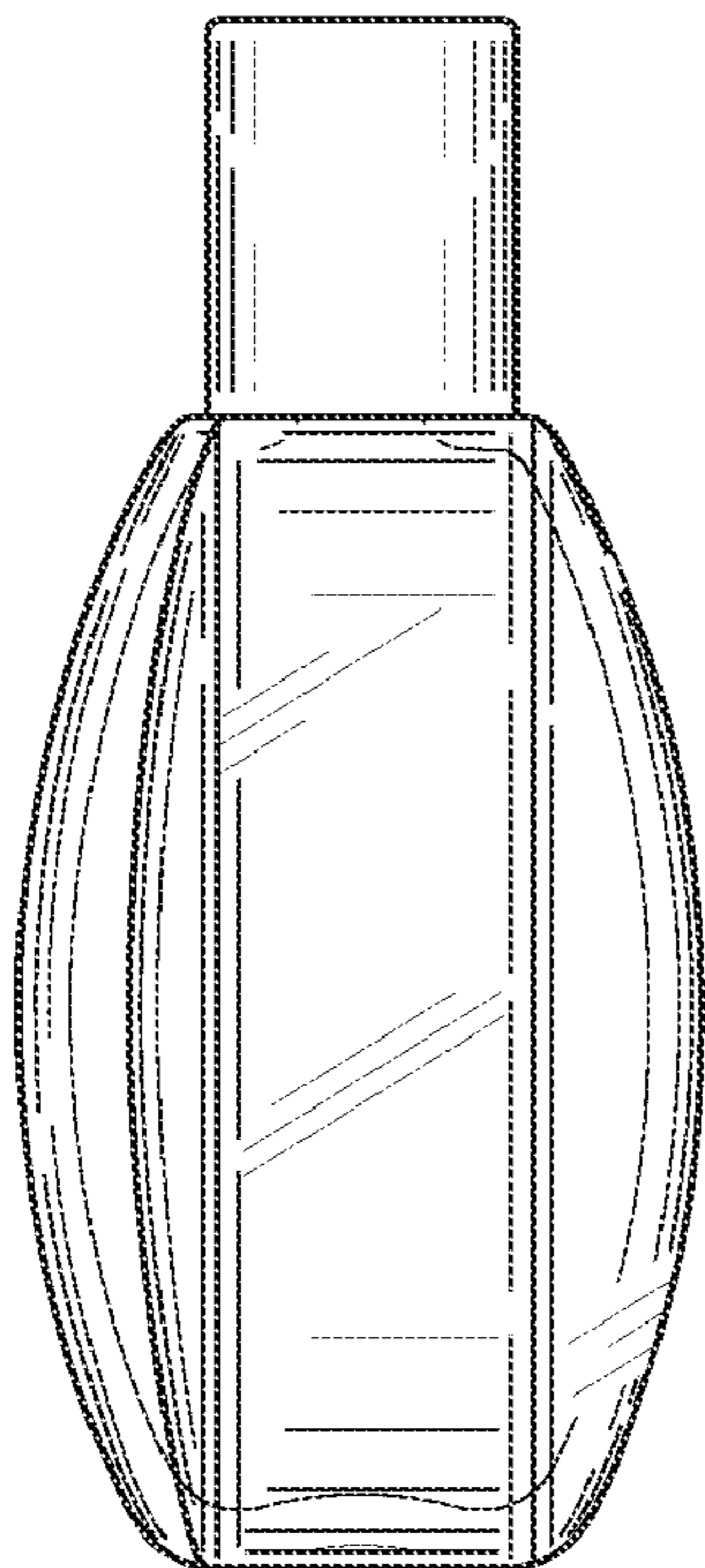

FIG. 5

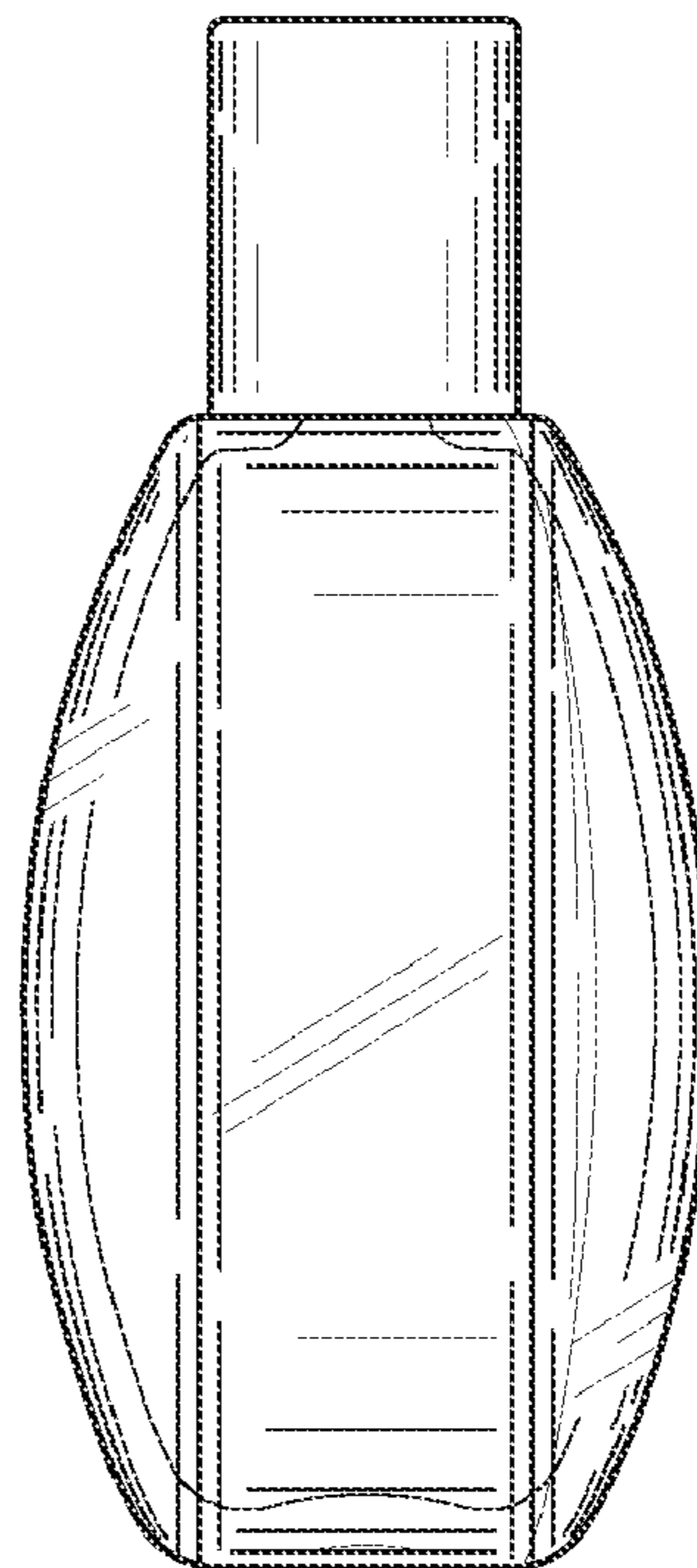

FIG. 6

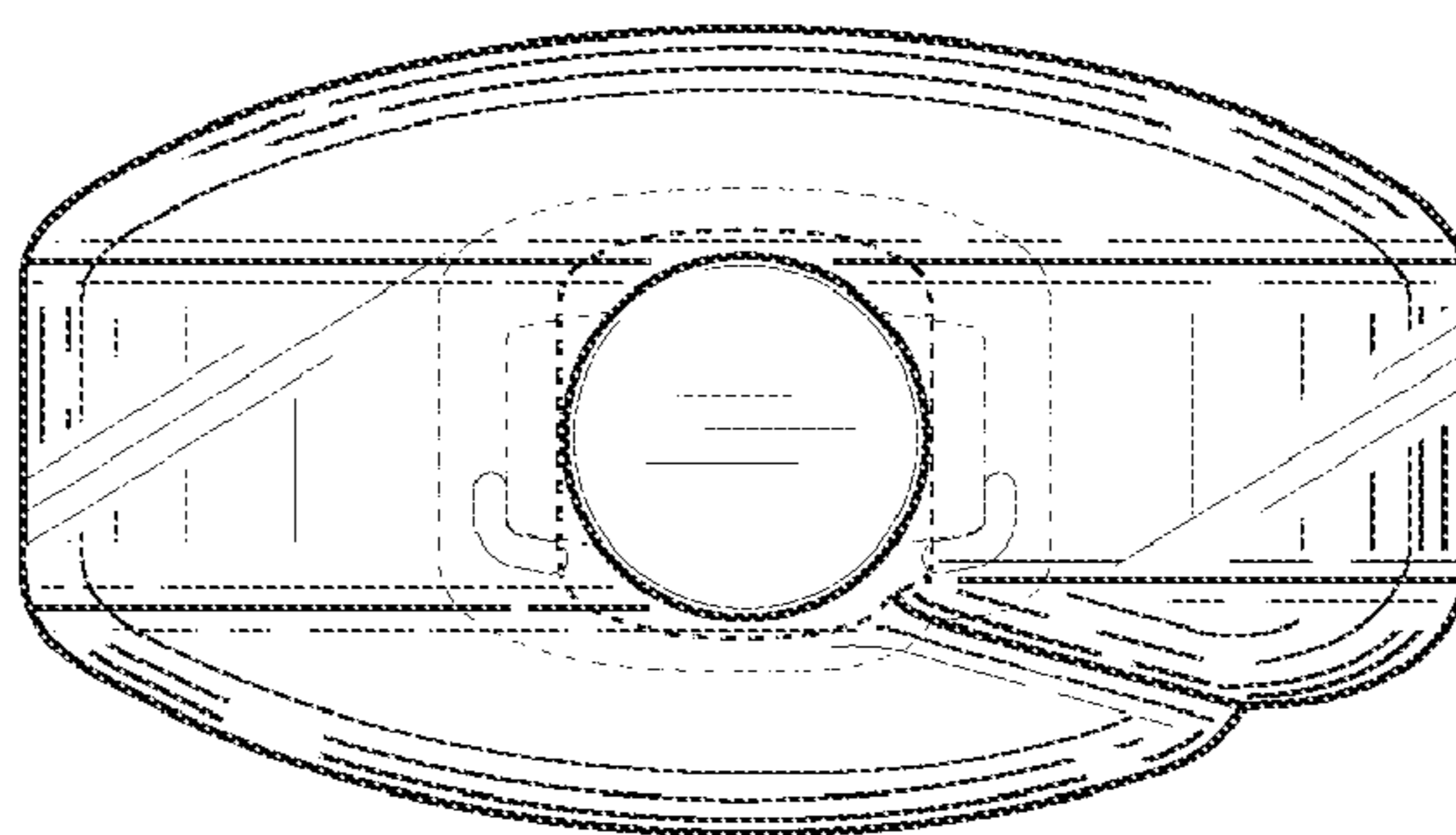

FIG. 7

