

US00D622093S

(12) **United States Design Patent**
Reiner

(10) **Patent No.:** **US D622,093 S**

(45) **Date of Patent:** **** Aug. 24, 2010**

(54) **FRYER**

(75) Inventor: **Guillaume Reiner**, Dijon (FR)

(73) Assignee: **SEB**, Selongey (FR)

(**) Term: **14 Years**

(21) Appl. No.: **29/350,433**

(22) Filed: **Nov. 17, 2009**

(30) **Foreign Application Priority Data**

May 19, 2009 (FR) 09 2453

(51) **LOC (9) Cl.** **07-02**

(52) **U.S. Cl.** **D7/354**

(58) **Field of Classification Search** D7/323,
D7/330-331, 339, 347, 350-367, 378-379,
D7/383-384, 391-395, 542-545, 560; 99/324-325,
99/329 R, 330-339, 400, 412-413, 425; 219/432-433,
219/438-441, 620-622, 725-730; 220/203.1,
220/203.07, 203.09, 298, 303, 316, 356.1,
220/573.1-574, 769, 912; 426/438, 441
See application file for complete search history.

(56) **References Cited**

U.S. PATENT DOCUMENTS

D339,957 S * 10/1993 Chang D7/354
D341,056 S * 11/1993 Powell D7/354
D418,361 S * 1/2000 Utsugi D7/354

D452,412 S * 12/2001 Jeong D7/354
D489,223 S * 5/2004 Kim et al. D7/358
D604,092 S * 11/2009 Kotani D7/354
D604,093 S * 11/2009 Moussu D7/360
D609,522 S * 2/2010 Nakatani D7/354

FOREIGN PATENT DOCUMENTS

FR 056340 2/2006

* cited by examiner

Primary Examiner—Caron Veynar

Assistant Examiner—Ricky Pham

(74) *Attorney, Agent, or Firm*—Browdy and Neimark, PLLC

(57) **CLAIM**

The ornamental design for a fryer, as shown.

DESCRIPTION

FIG. 1 is a front elevational view of a fryer in accordance with the present design;

FIG. 2 is a rear elevational view thereof;

FIG. 3 is a left side elevational view thereof;

FIG. 4 is a right side elevational view thereof;

FIG. 5 is a top plan view thereof;

FIG. 6 is a bottom plan view thereof; and,

FIG. 7 is a three quarter perspective view thereof.

1 Claim, 7 Drawing Sheets

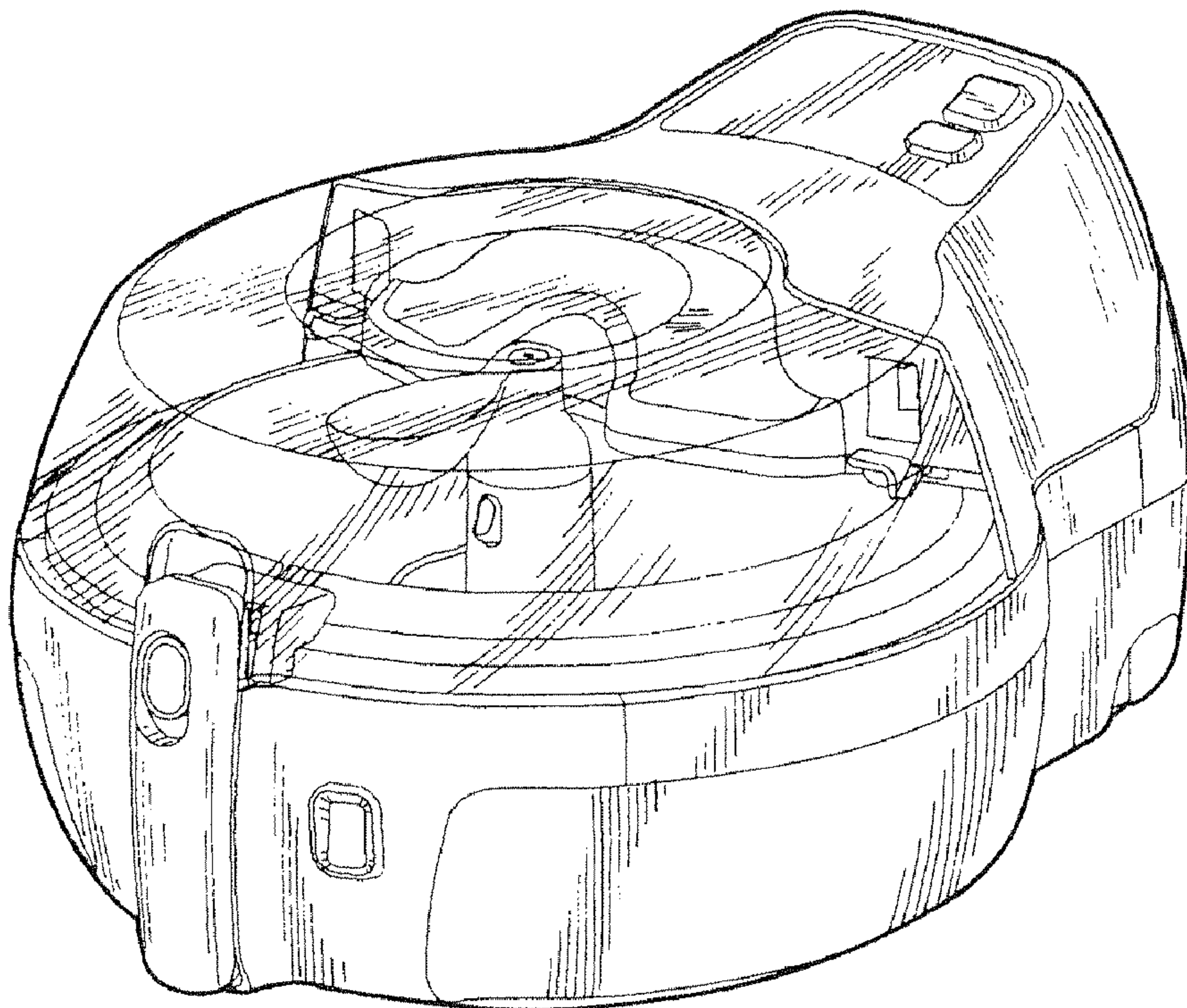

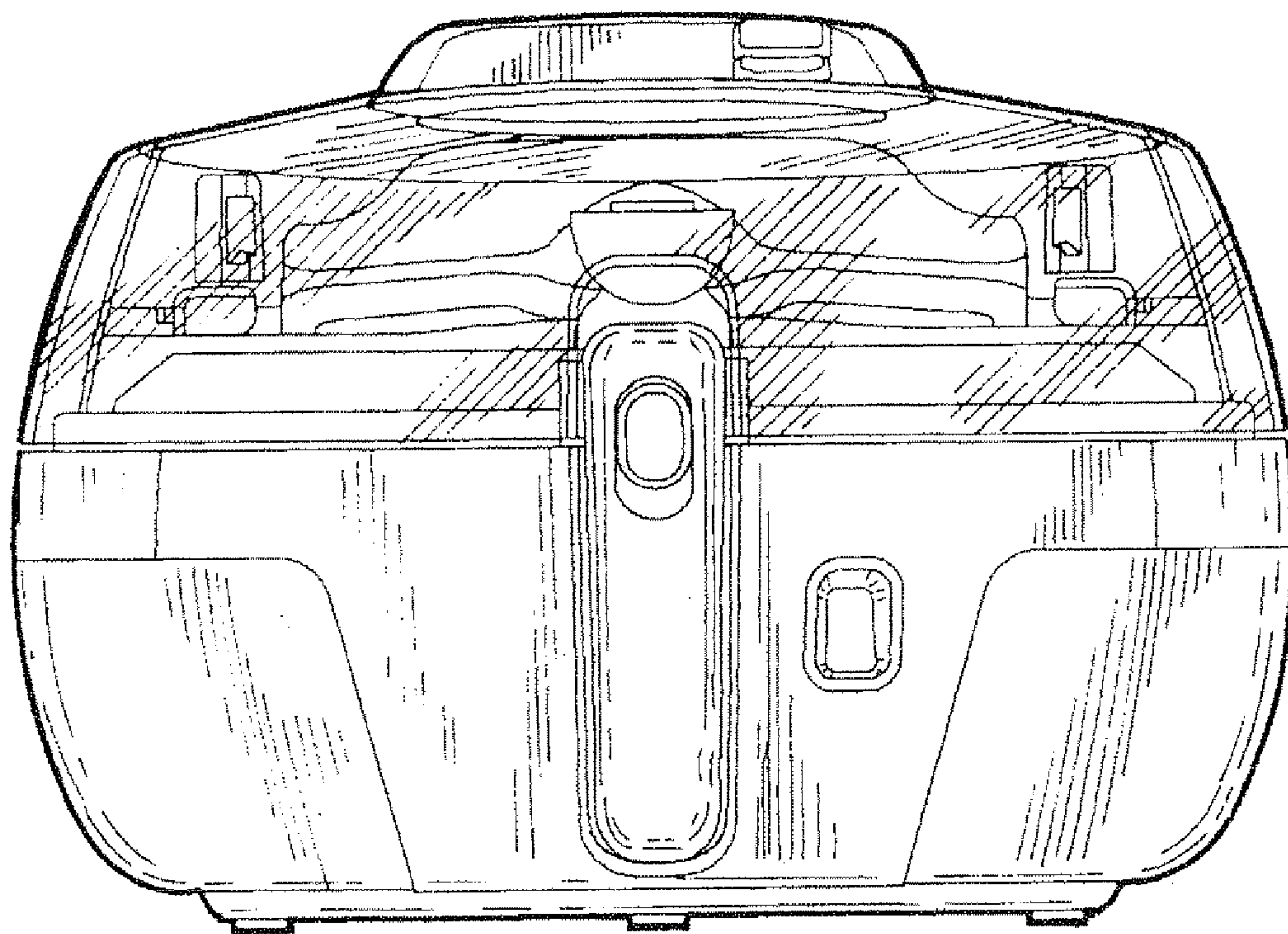

Fig. 1

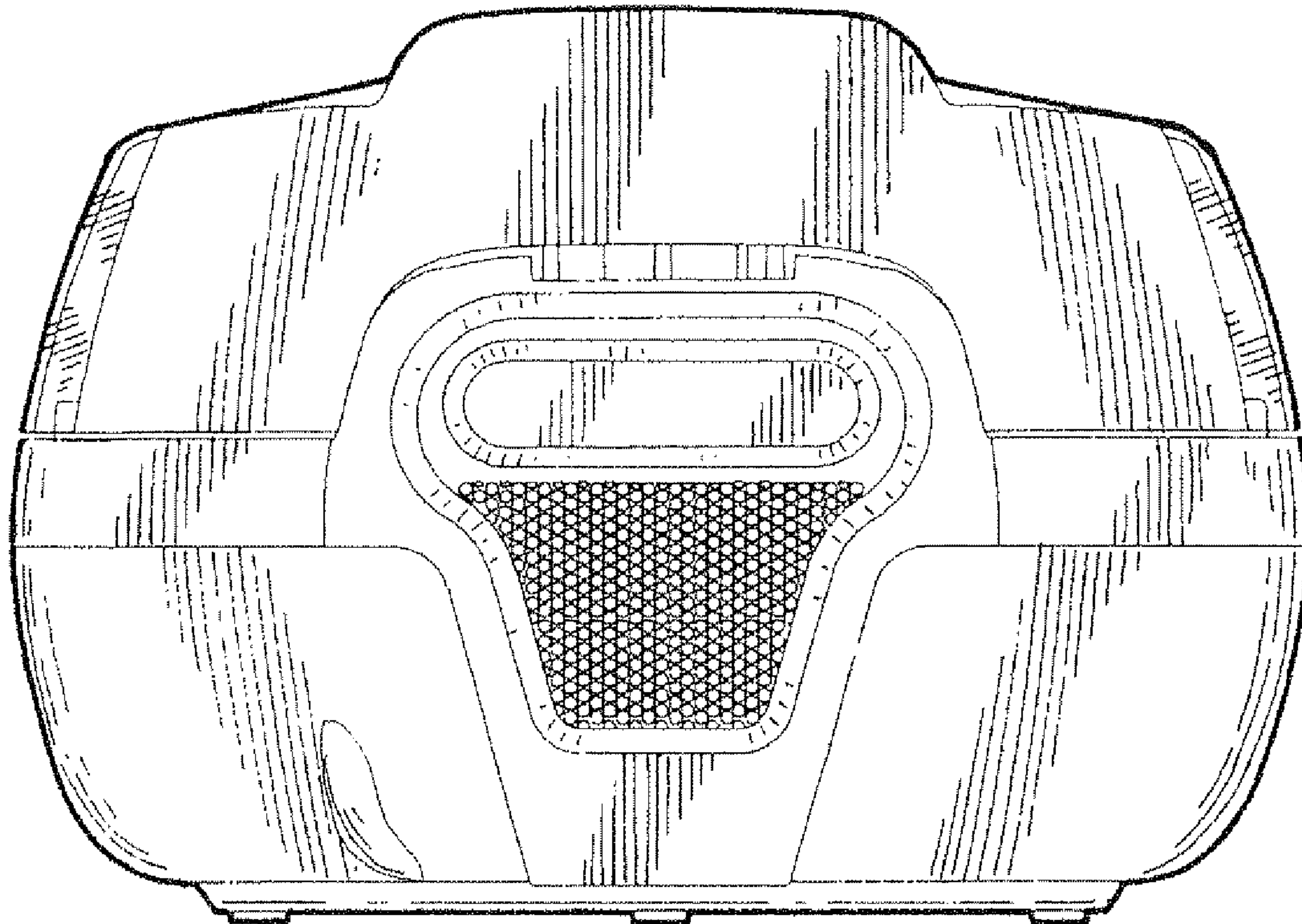

Fig.2

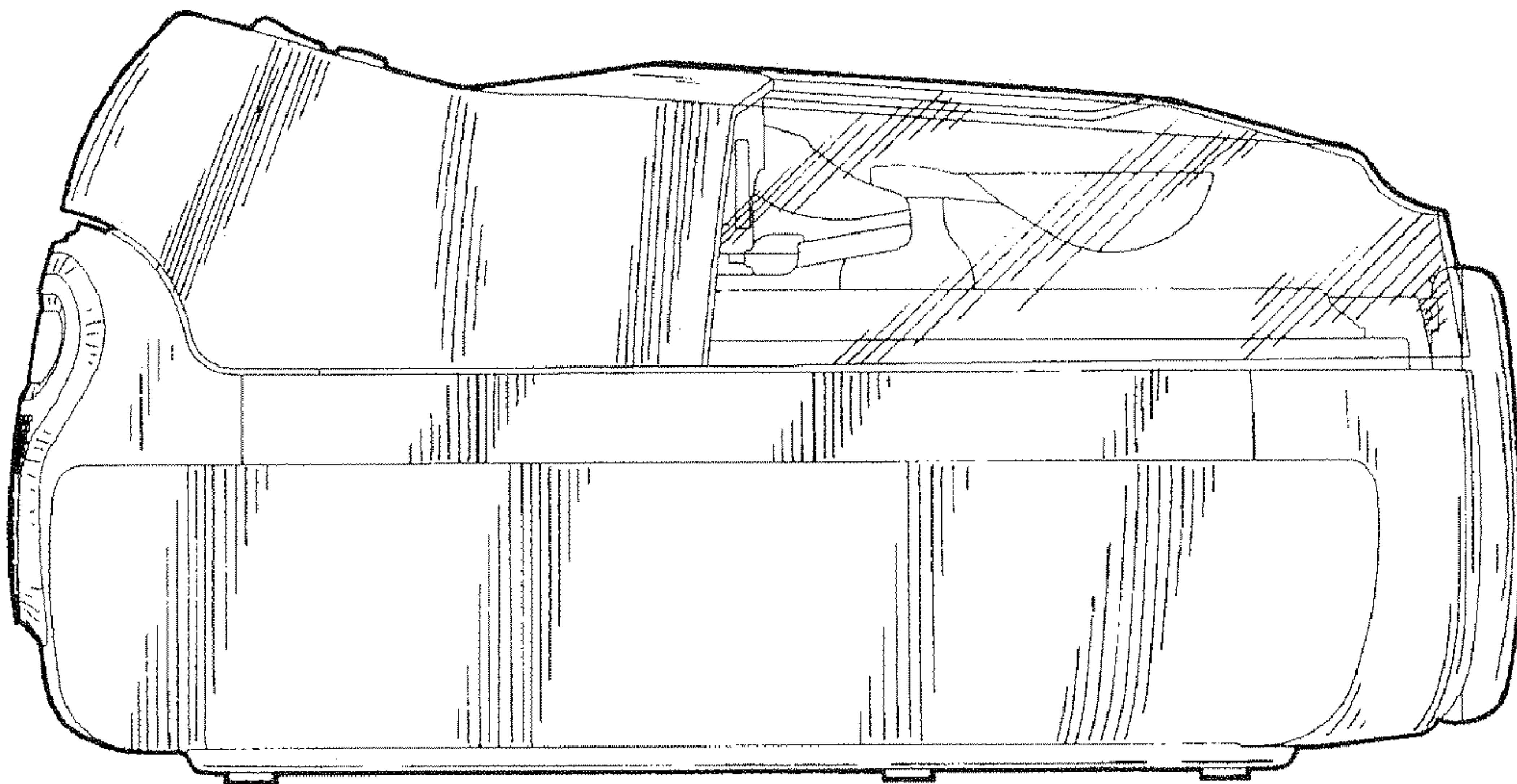

Fig.3

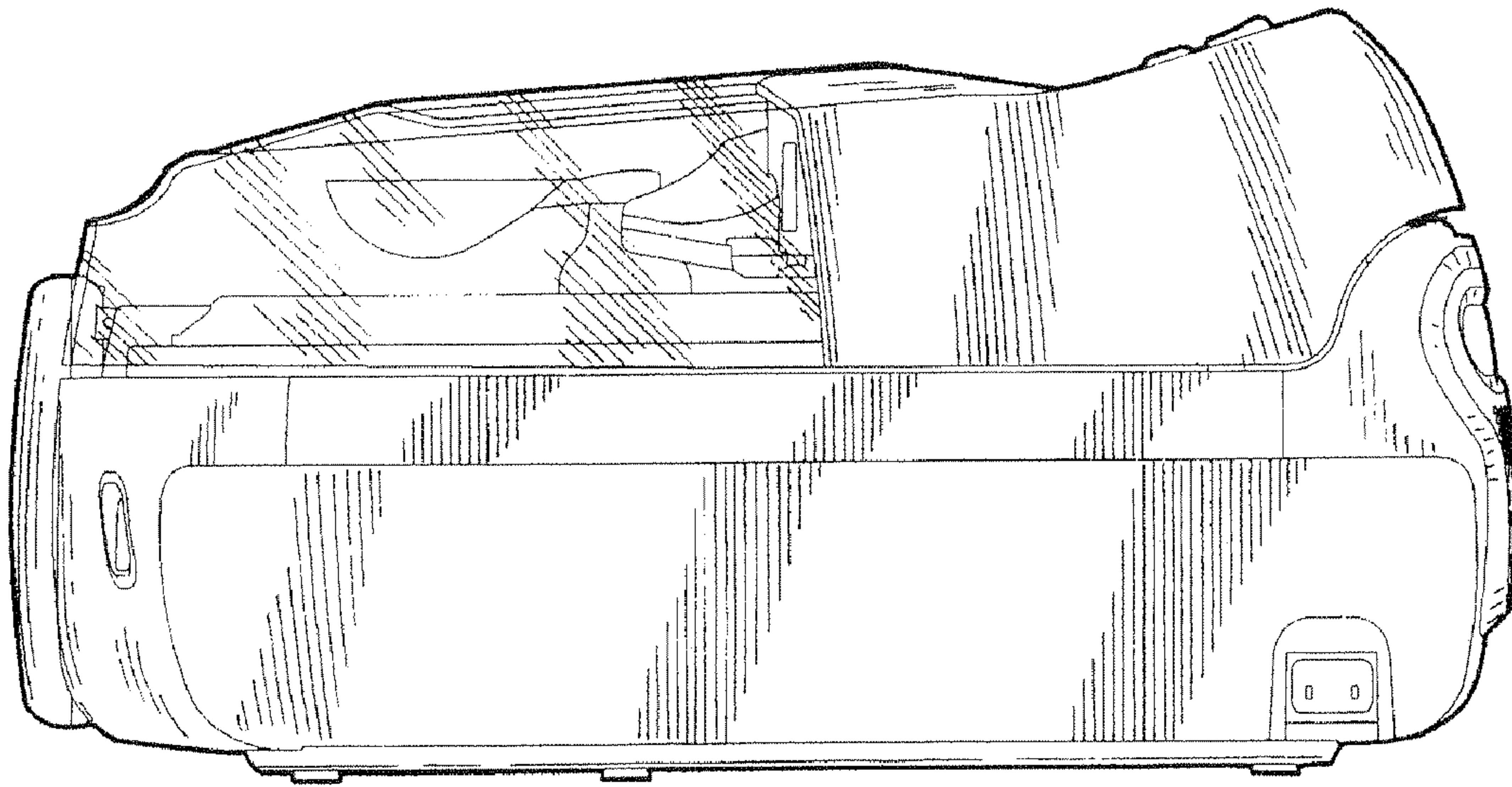

Fig. 4

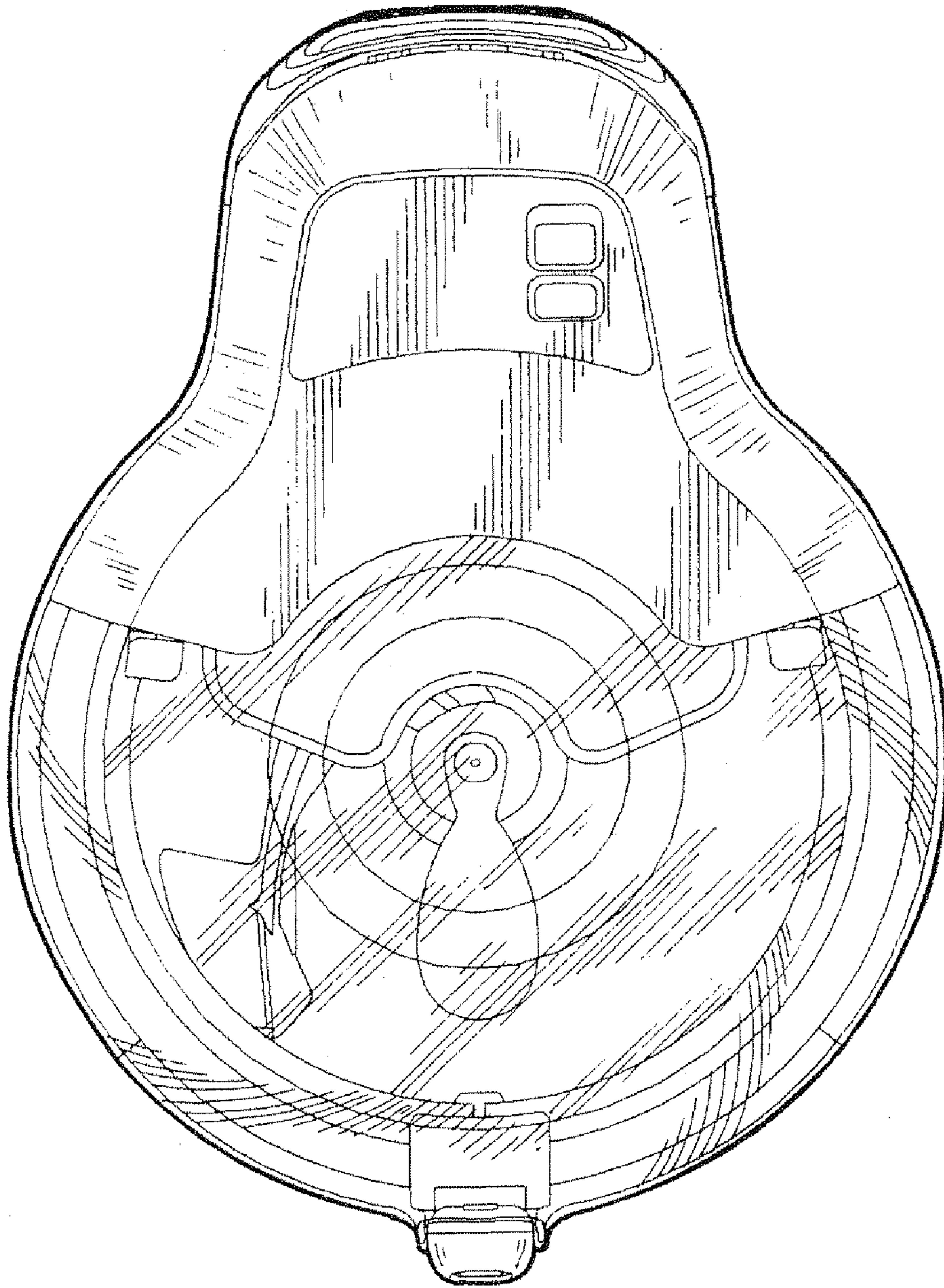

Fig. 5

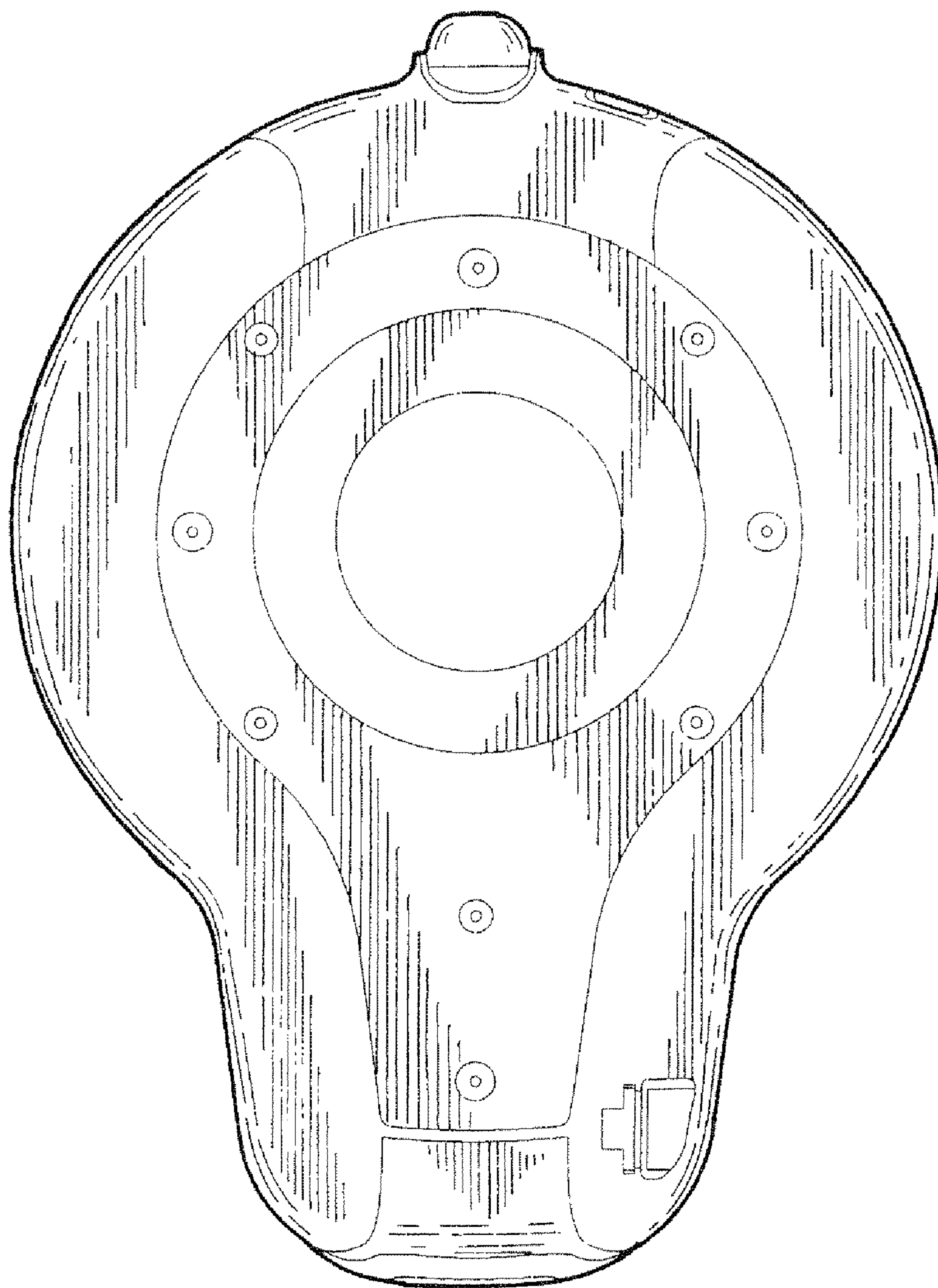

Fig.6

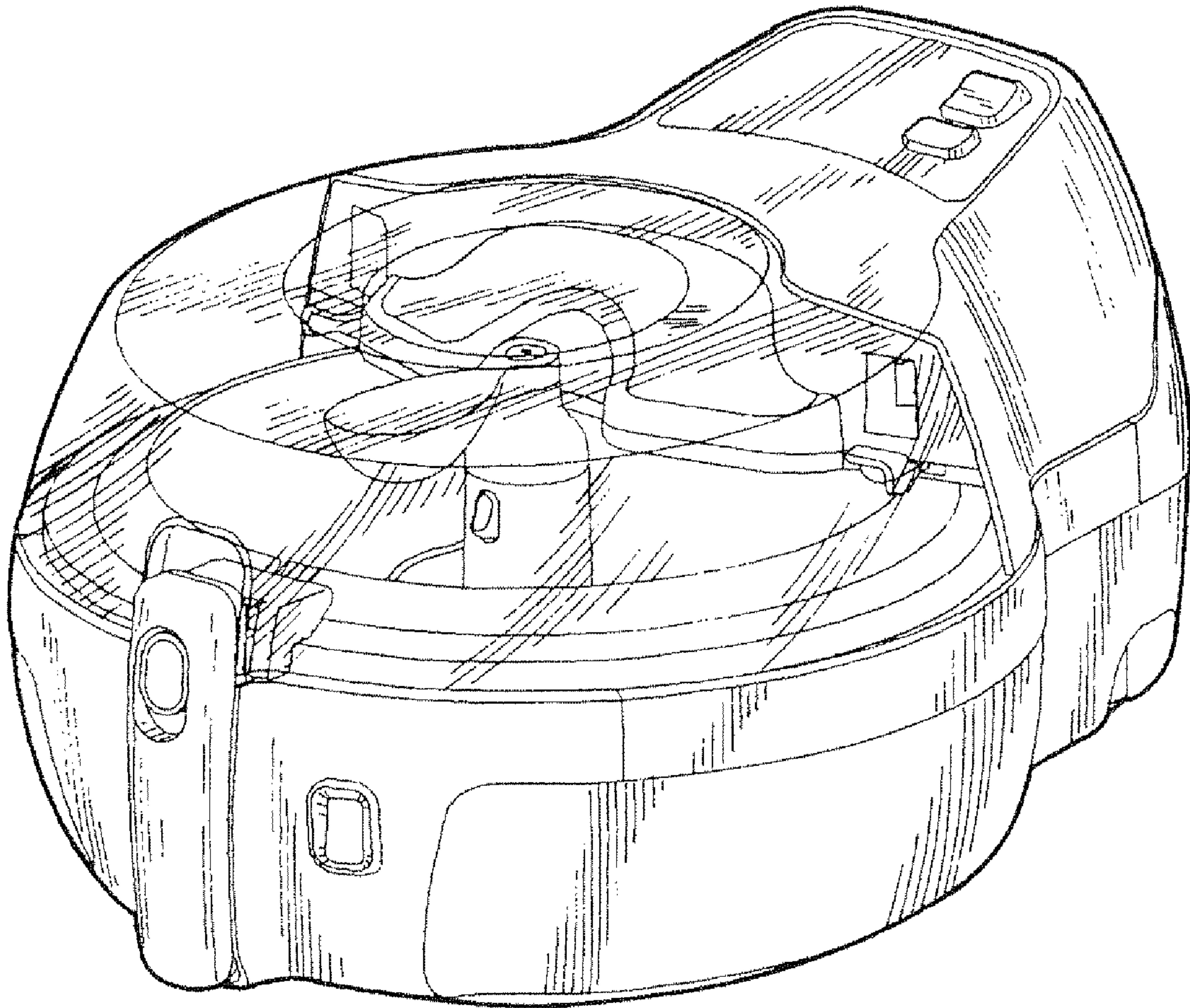

Fig. 7