



US00D621777S

(12) **United States Design Patent**
Shmul

(10) **Patent No.:** **US D621,777 S**

(45) **Date of Patent:** **** Aug. 17, 2010**

(54) **CAR COVER**

5,902,002 A * 5/1999 Wilson 296/97.13
D417,481 S * 12/1999 Schwartz et al. D21/836
D511,132 S * 11/2005 Stover D12/401

(76) Inventor: **Shlomo Shmul**, 13, Nehamia Tamari
Street, Kiryat Motzkin (IL) 26231

* cited by examiner

(**) Term: **14 Years**

Primary Examiner—Caron Veynar
Assistant Examiner—Katrina A Kile

(21) Appl. No.: **29/353,253**

(74) *Attorney, Agent, or Firm*—Frishauf, Holtz, Goodman &
Chick, P.C.

(22) Filed: **Jan. 6, 2010**

(51) **LOC (9) Cl.** **12-16**

(57) **CLAIM**

(52) **U.S. Cl.** **D12/401**

The ornamental design for a car cover, as shown and
described.

(58) **Field of Classification Search** D12/400,
D12/401, 404, 406, 412, 414, 222, 223, 86,
D12/93, 101; 224/923, 924; 211/100, 124,
211/2, 4, 85.7; D6/552

DESCRIPTION

See application file for complete search history.

FIG. 1 is a front, top, right perspective view of the car cover
showing my new design;

(56) **References Cited**

FIG. 2 is a front perspective view thereof;

U.S. PATENT DOCUMENTS

FIG. 3 is a top plan view thereof;

4,324,427 A * 4/1982 Huang et al. 293/106
5,014,758 A * 5/1991 Stinson 150/168
D317,283 S * 6/1991 Gray D12/401
5,112,098 A * 5/1992 Lichtmann 296/136.07
5,273,316 A * 12/1993 Infante 280/770
5,413,396 A * 5/1995 Poznansky et al. 296/136.13
5,435,362 A * 7/1995 Chiang 150/166
5,497,819 A * 3/1996 Chiang 150/166
D375,078 S * 10/1996 Cobb D12/401
5,791,361 A * 8/1998 Chong 135/88.01

FIG. 4 is a right-side elevational view thereof, the left side
being a mirror image thereof;

FIG. 5 is a rear elevational view thereof; and,

FIG. 6 is a bottom plan view thereof.

In the drawings, the broken lines in FIG. 1 depict a car and
form no part of the claimed design.

1 Claim, 3 Drawing Sheets

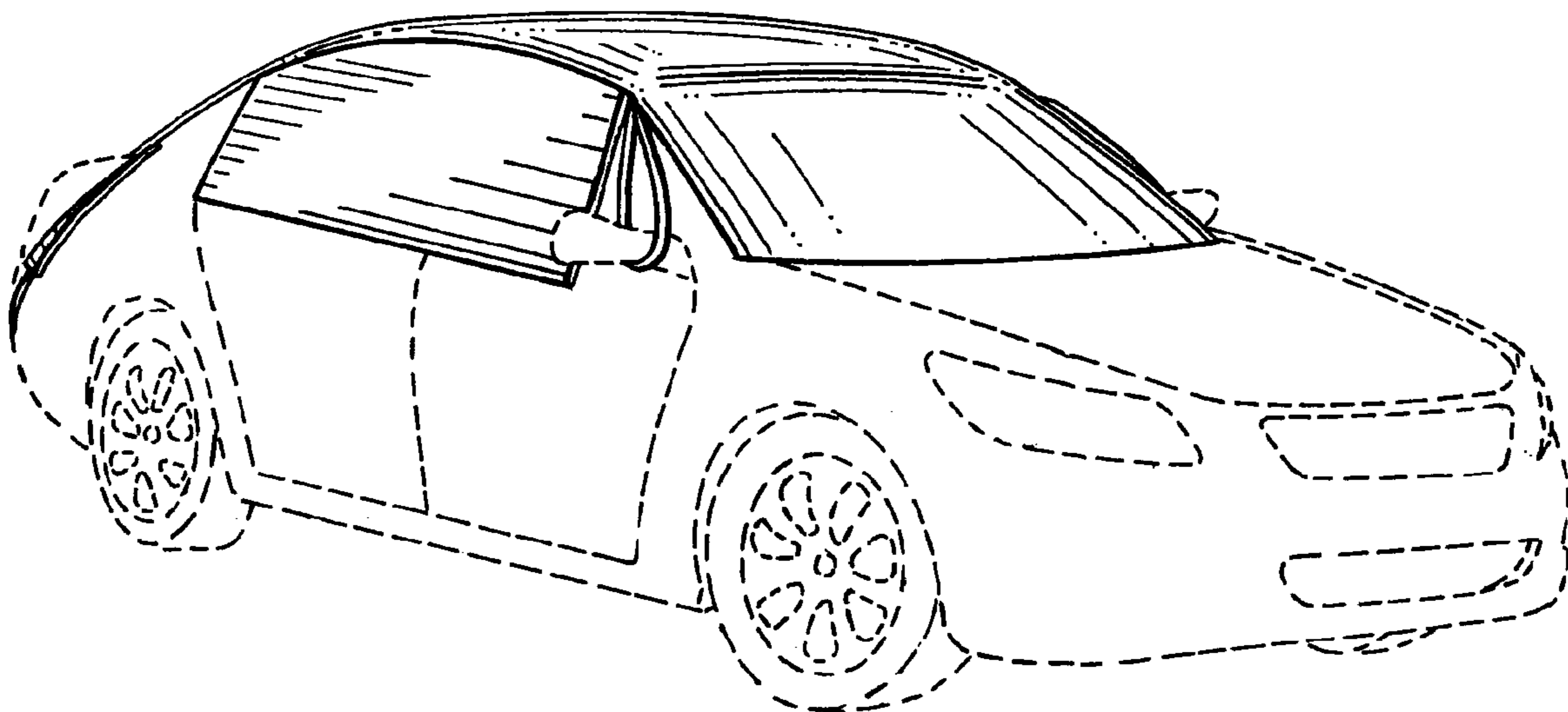

FIG. 1

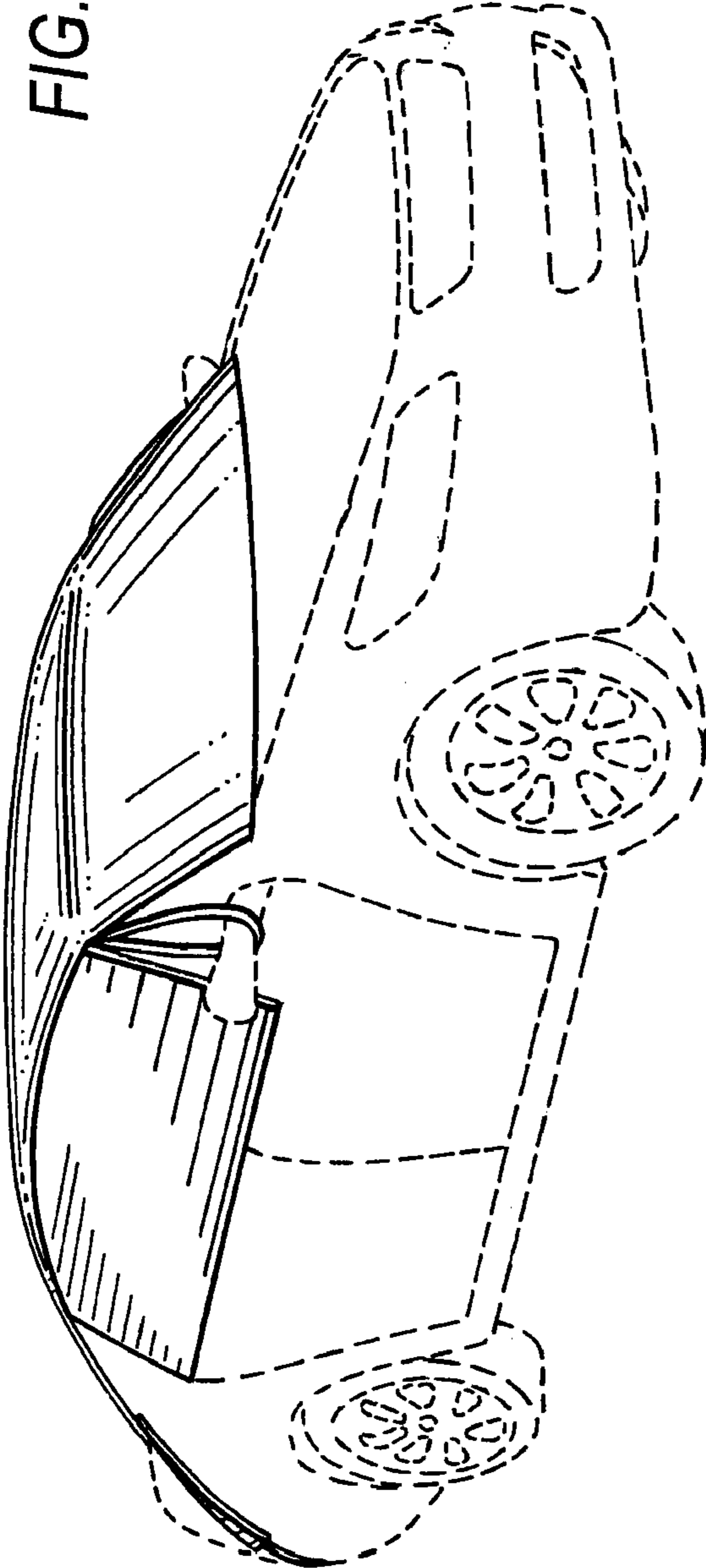

FIG. 2

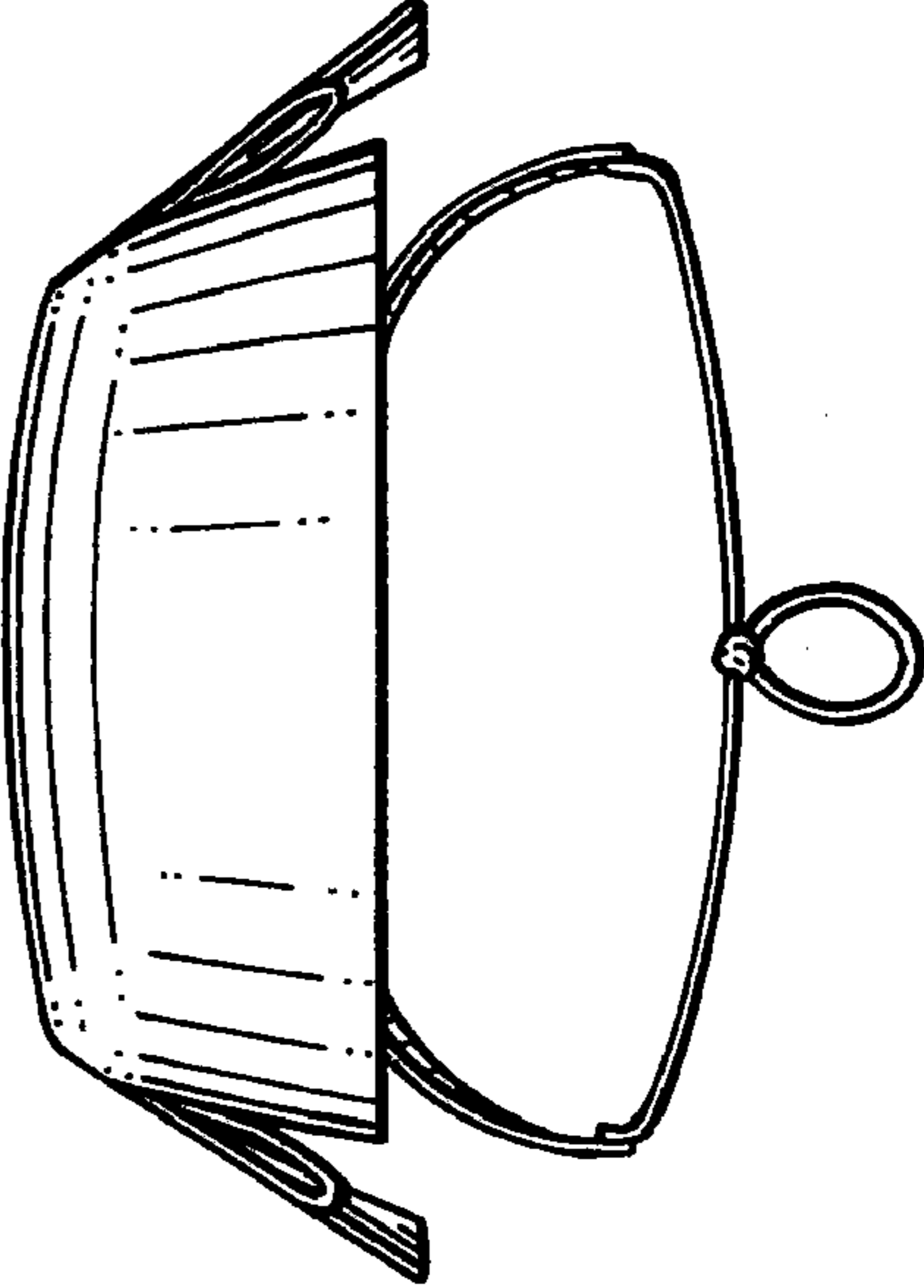

FIG. 3

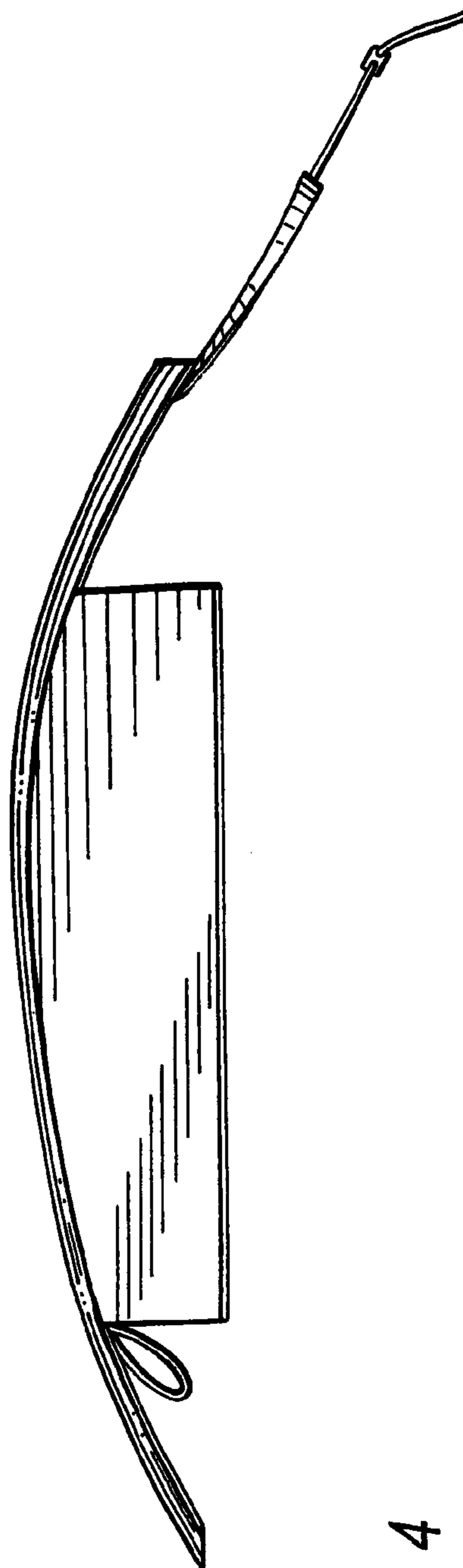
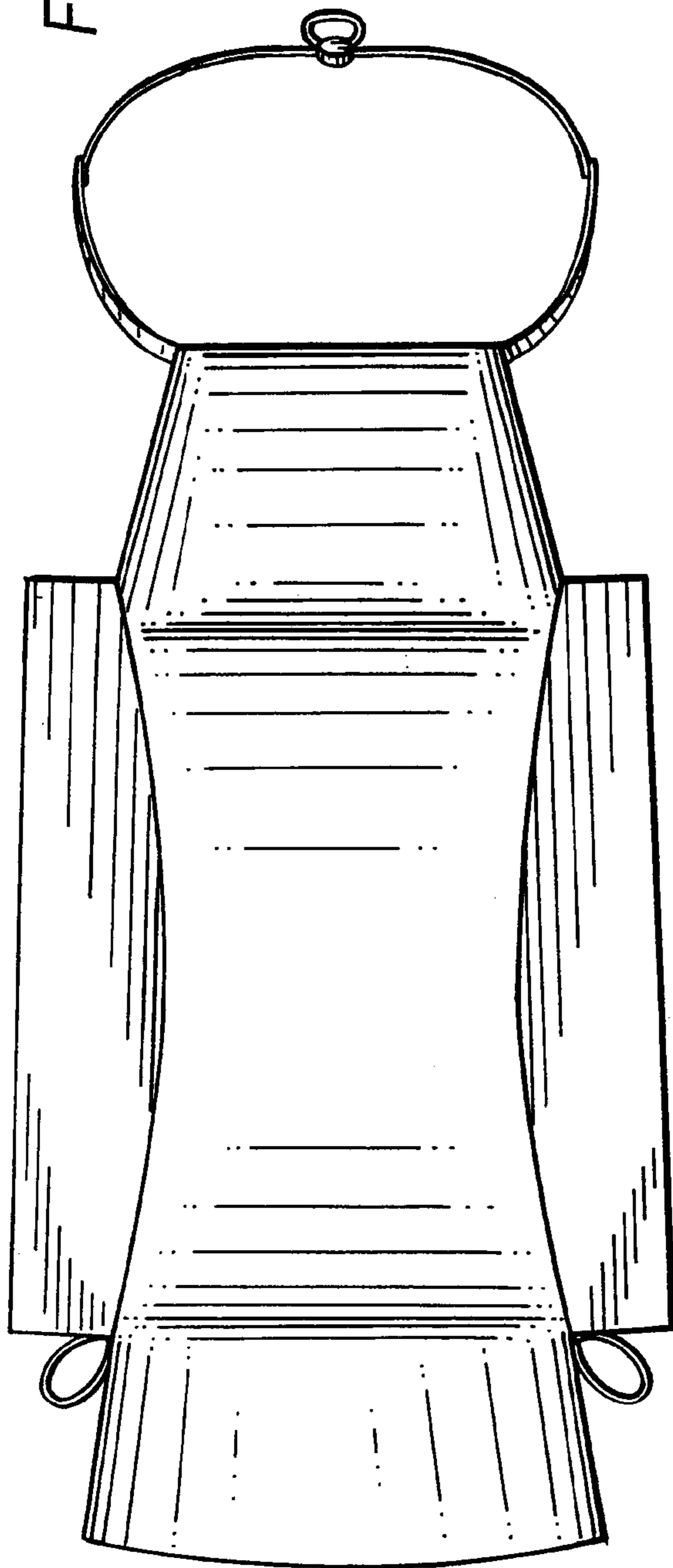

FIG. 4

FIG. 5

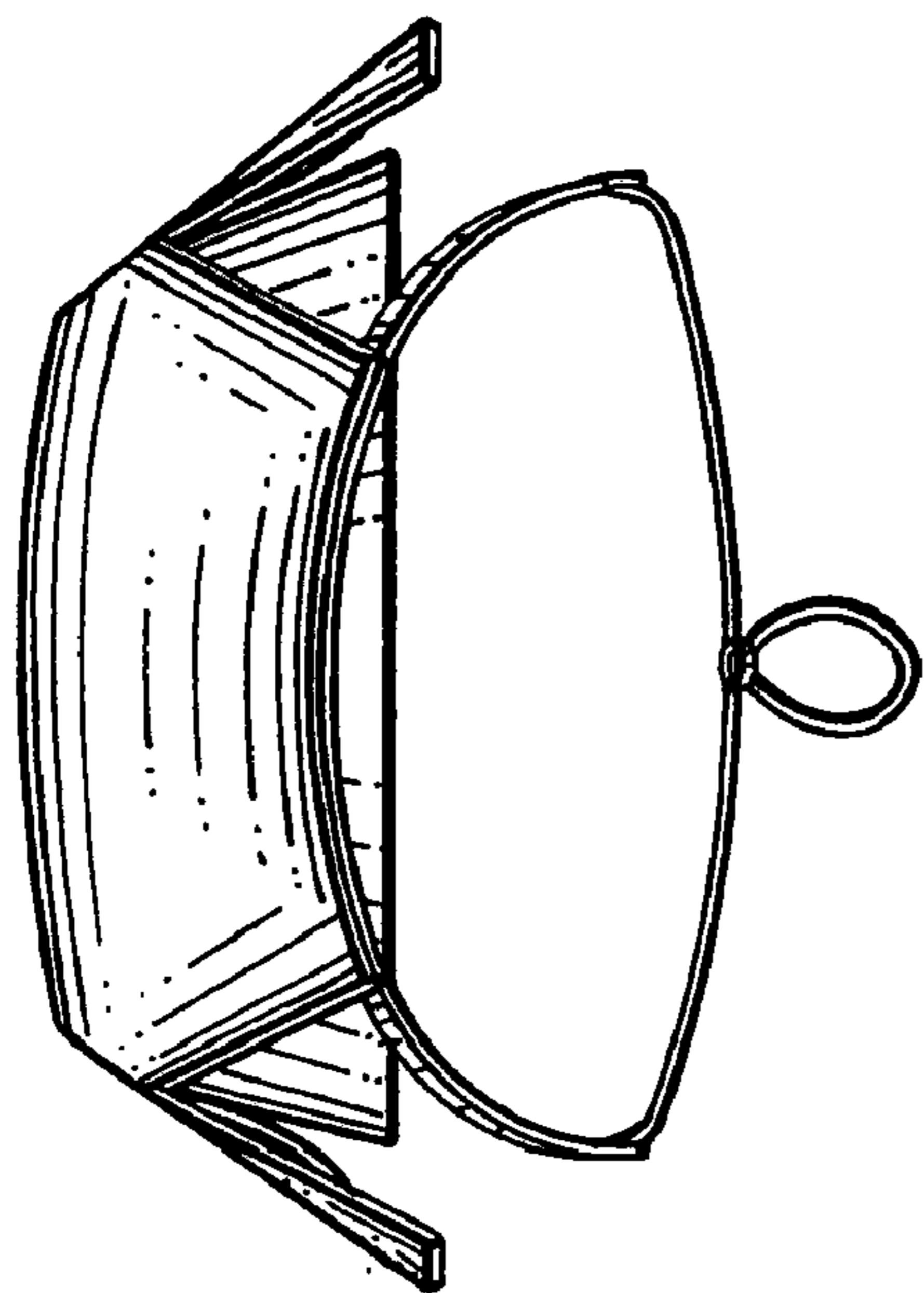

FIG. 6

