



US00D621739S

(12) **United States Design Patent**  
**Marks**

(10) **Patent No.:** **US D621,739 S**

(45) **Date of Patent:** **\*\* Aug. 17, 2010**

(54) **PENDANT**

(75) Inventor: **Sandy Marks**, Dallas, TX (US)

(73) Assignee: **SBRE, LLC**, New York, NY (US)

(\*\*) Term: **14 Years**

(21) Appl. No.: **29/338,049**

(22) Filed: **Jun. 3, 2009**

(51) **LOC (9) Cl.** ..... **11-01**

(52) **U.S. Cl.** ..... **D11/79**

(58) **Field of Classification Search** ..... D11/40-48,  
D11/1-2, 93, 94, 74-78, 79-85; 63/12, 13,  
63/1.11, 26, 28, 14.1-14.8

See application file for complete search history.

(56) **References Cited**

**U.S. PATENT DOCUMENTS**

D17,349 S *	5/1887	Katz	.....	D10/35
1,732,250 A *	10/1929	Wehse	.....	63/14.2
D150,546 S *	8/1948	Boucher	.....	D11/40
D173,224 S *	10/1954	Katz	.....	D11/45
3,613,393 A *	10/1971	Lamoureux	.....	63/14.5
D248,380 S *	7/1978	Burchett	.....	D11/43
D256,003 S *	7/1980	Barr	.....	D11/43
D301,318 S *	5/1989	Yoshida	.....	D11/79
D354,016 S *	1/1995	Schubert	.....	D11/42
D394,226 S	5/1998	Bell		
D429,474 S *	8/2000	Stein	.....	D11/79
D455,097 S *	4/2002	Salvarani	.....	D11/79
D519,875 S *	5/2006	Bulgari	.....	D11/79
D525,897 S	8/2006	Raiman		
D550,582 S	9/2007	Gruosi-Scheufele		
D552,009 S	10/2007	Jemente		
D567,132 S *	4/2008	Bulgari	.....	D11/43

\* cited by examiner

*Primary Examiner*—Caron Veynar

*Assistant Examiner*—Melanie Levy

(74) *Attorney, Agent, or Firm*—Pearl Cohen Zedek Latzer, LLP

(57) **CLAIM**

The ornamental design for a pendant, as shown and described.

**DESCRIPTION**

FIG. 1 is a top, front right side perspective view of a first embodiment of the pendant;

FIG. 2 is a front elevational view;

FIG. 3 is a right side elevational view thereof;

FIG. 4 is a left side elevational view thereof;

FIG. 5 is a top plan view thereof;

FIG. 6 is a bottom plan view thereof;

FIG. 7 is a top, front right side perspective view of a second embodiment of the pendant;

FIG. 8 is a front elevational view;

FIG. 9 is a right side elevational view thereof;

FIG. 10 is a left side elevational view thereof;

FIG. 11 is a top plan view thereof; and,

FIG. 12 is a bottom plan view thereof.

The broken line portions are shown for environmental purposes and form no part of the claimed design.

Because a portion of the article is not solid, the remote side of the article is normally visible through the fore side of the article in the side view but is not shown in the figures for ease of illustration.

**1 Claim, 6 Drawing Sheets**

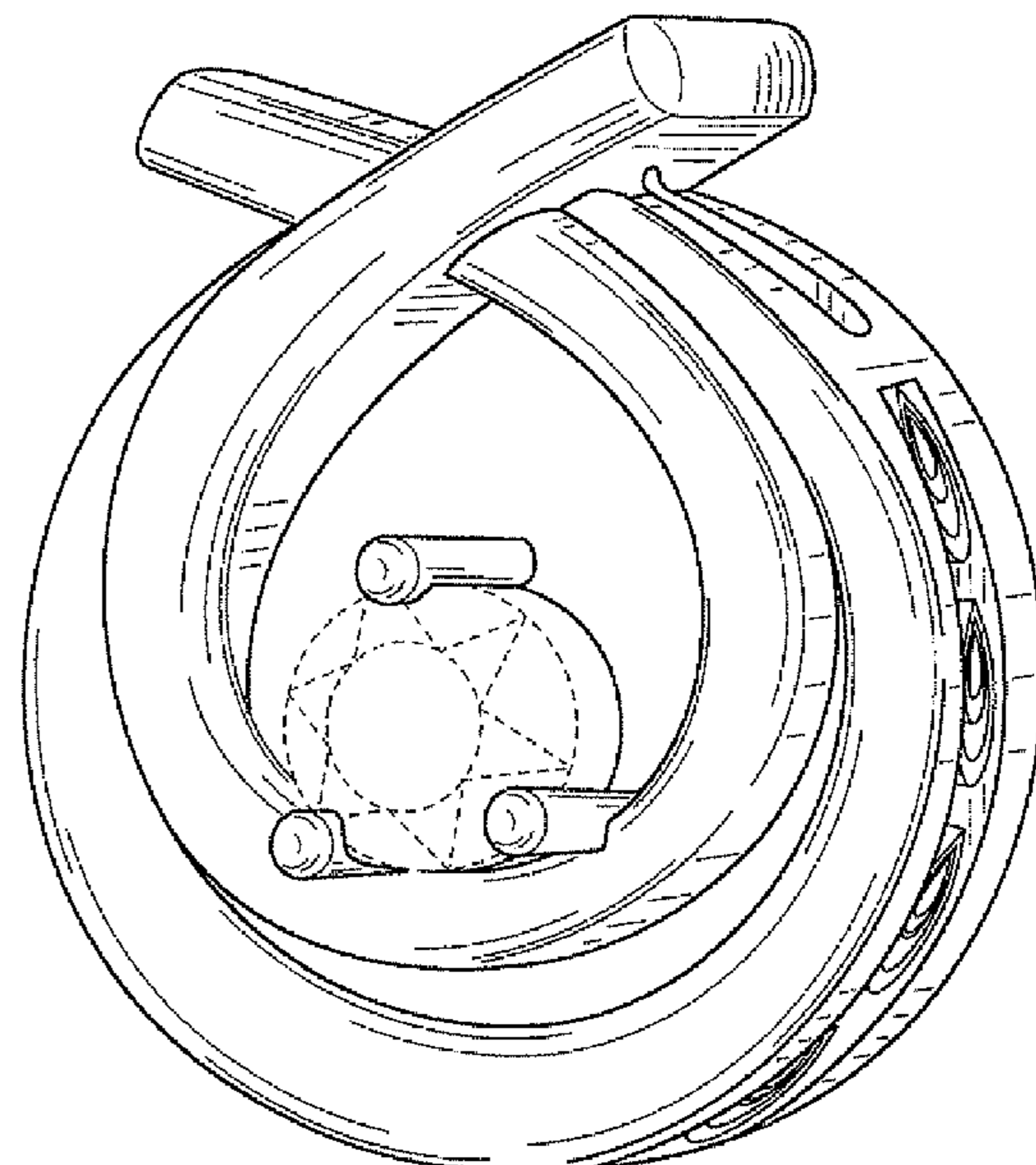
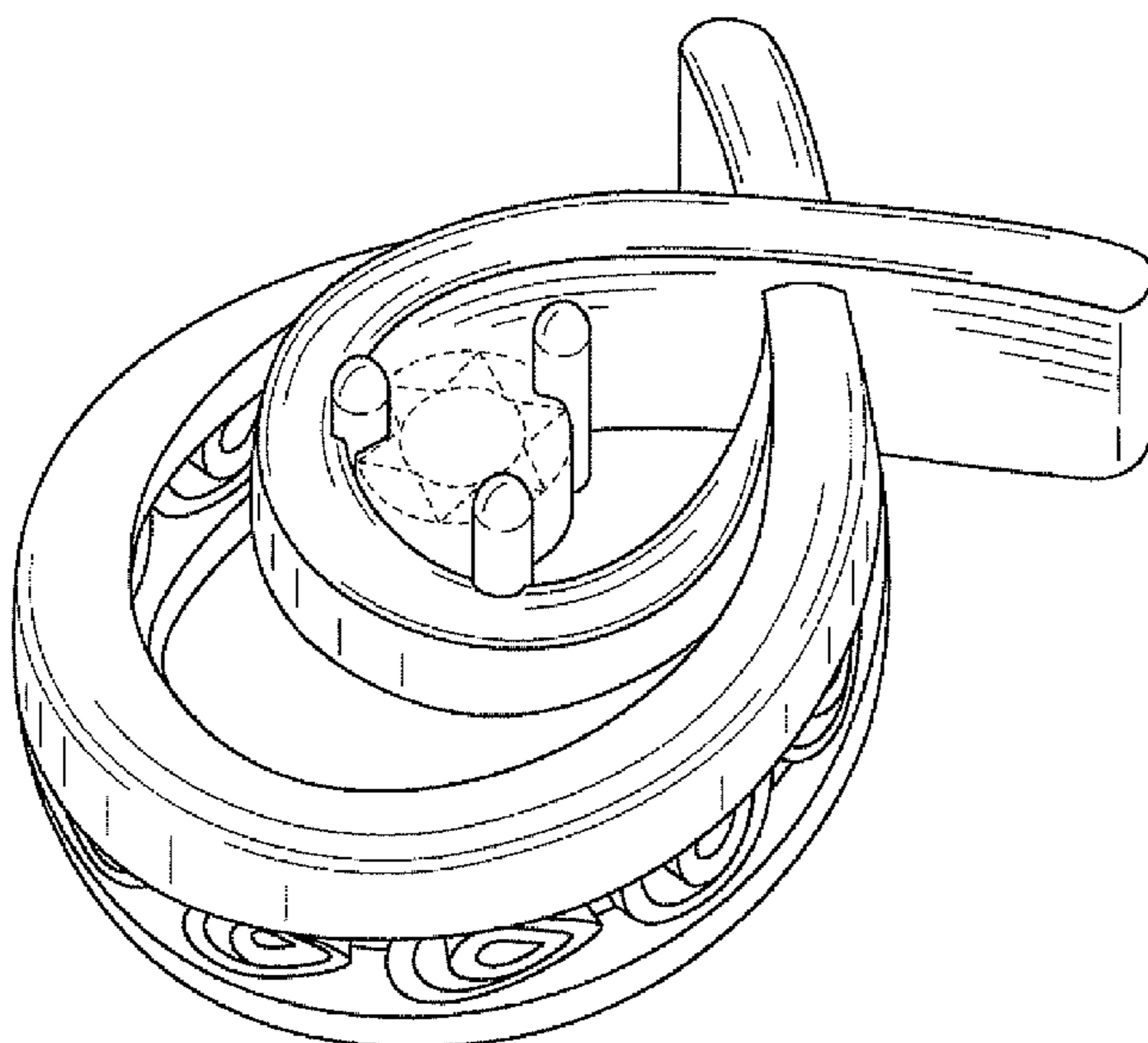

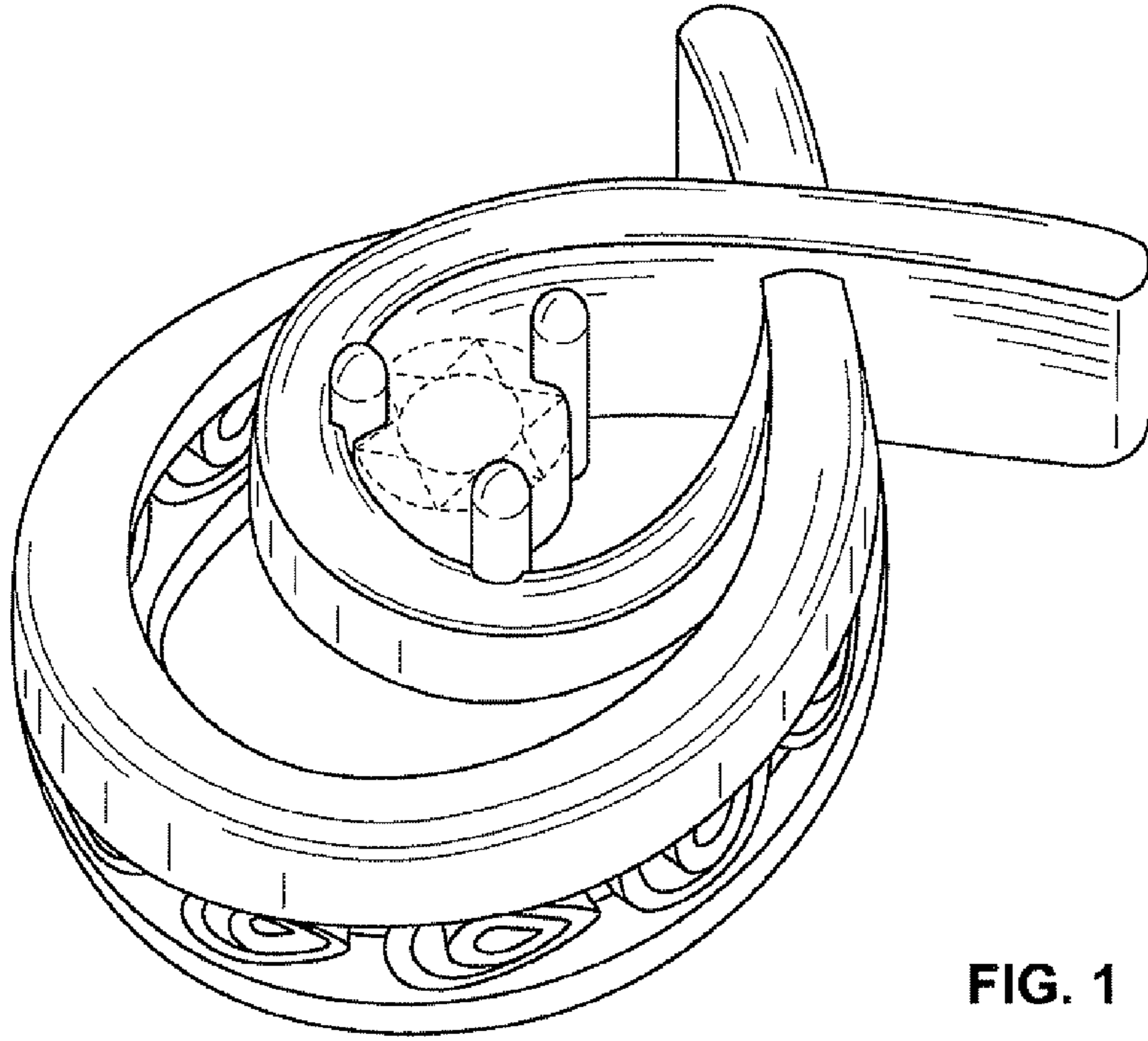

FIG. 1

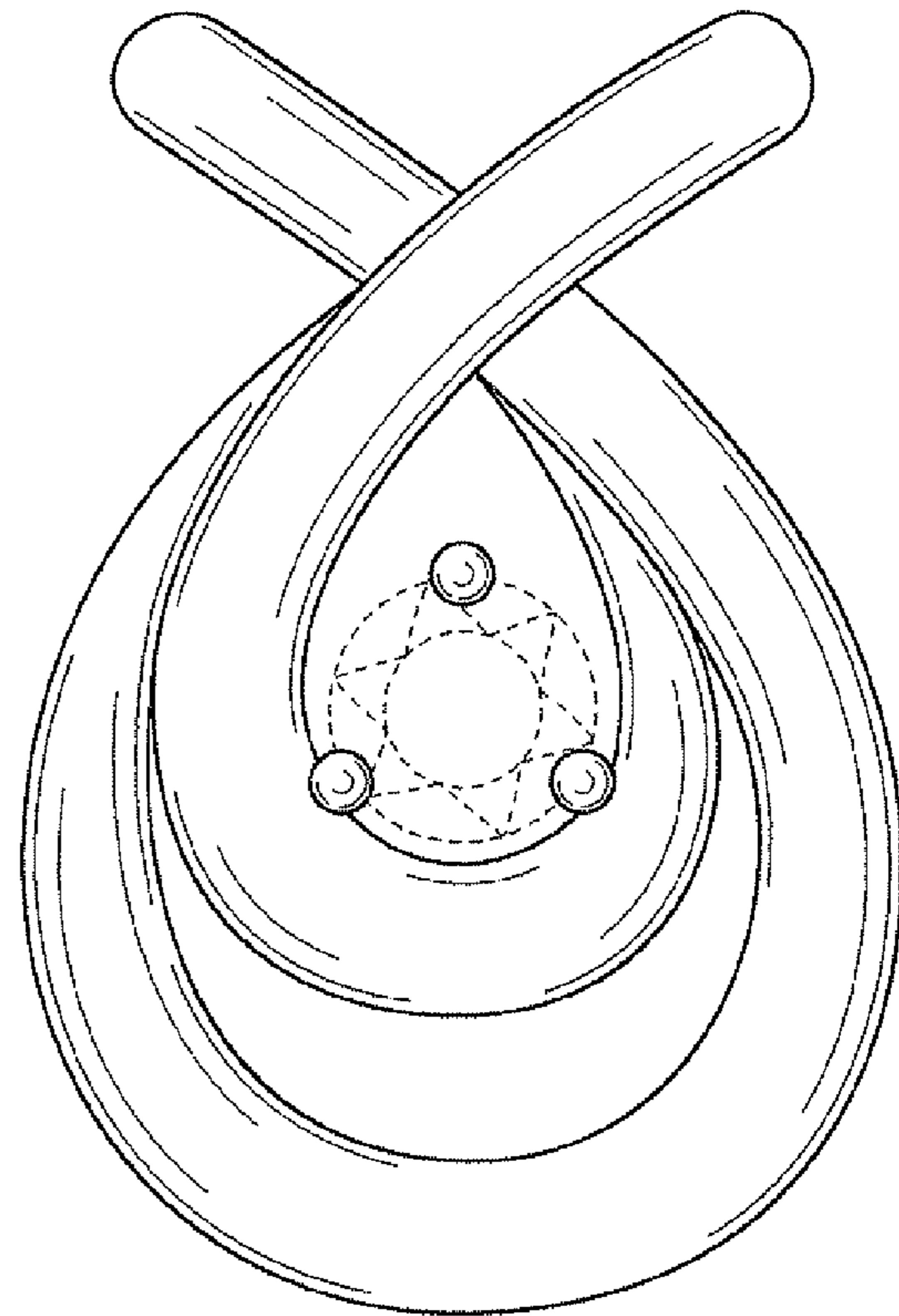

FIG. 2

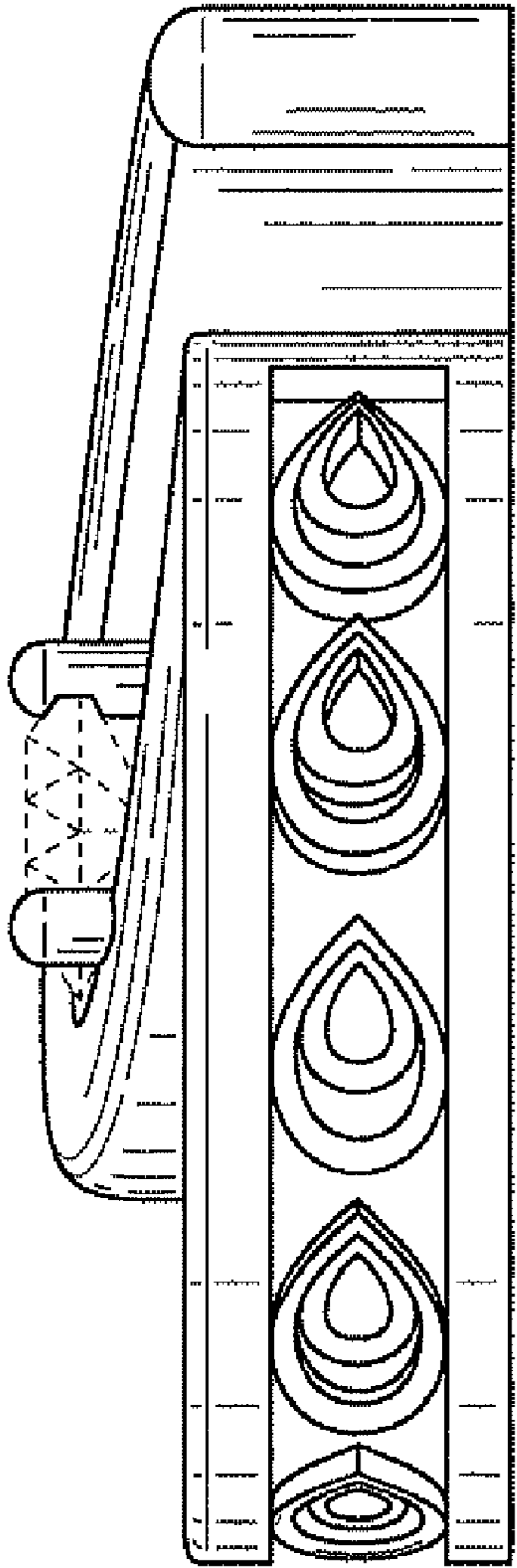

FIG. 3

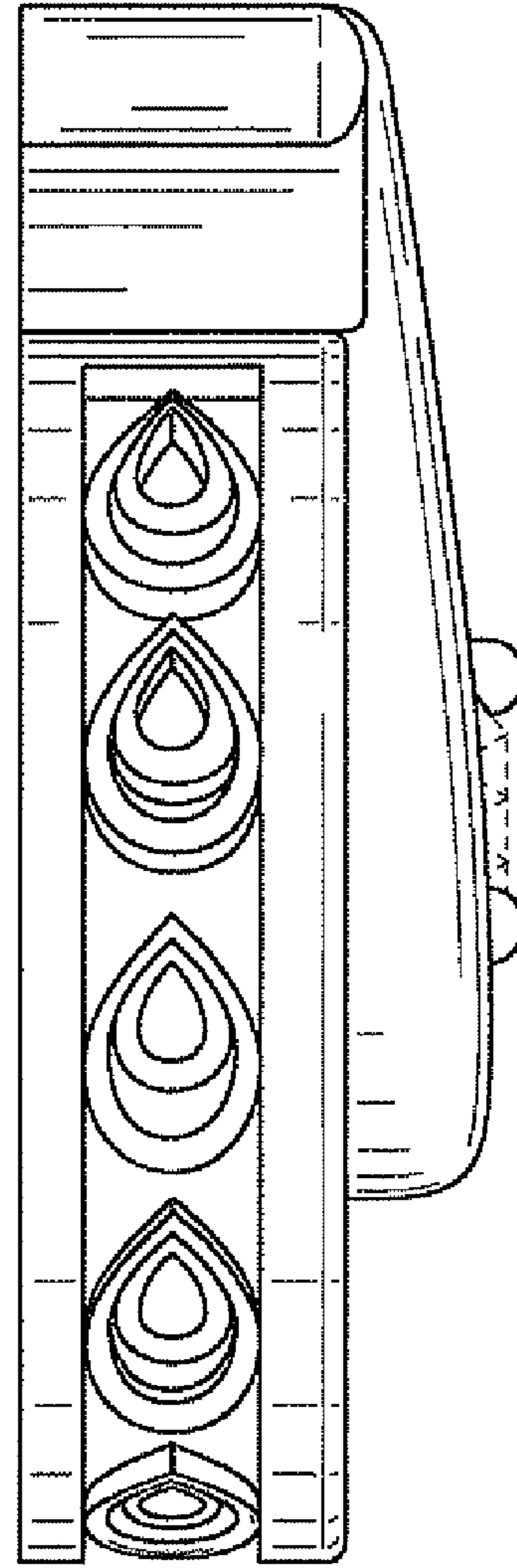
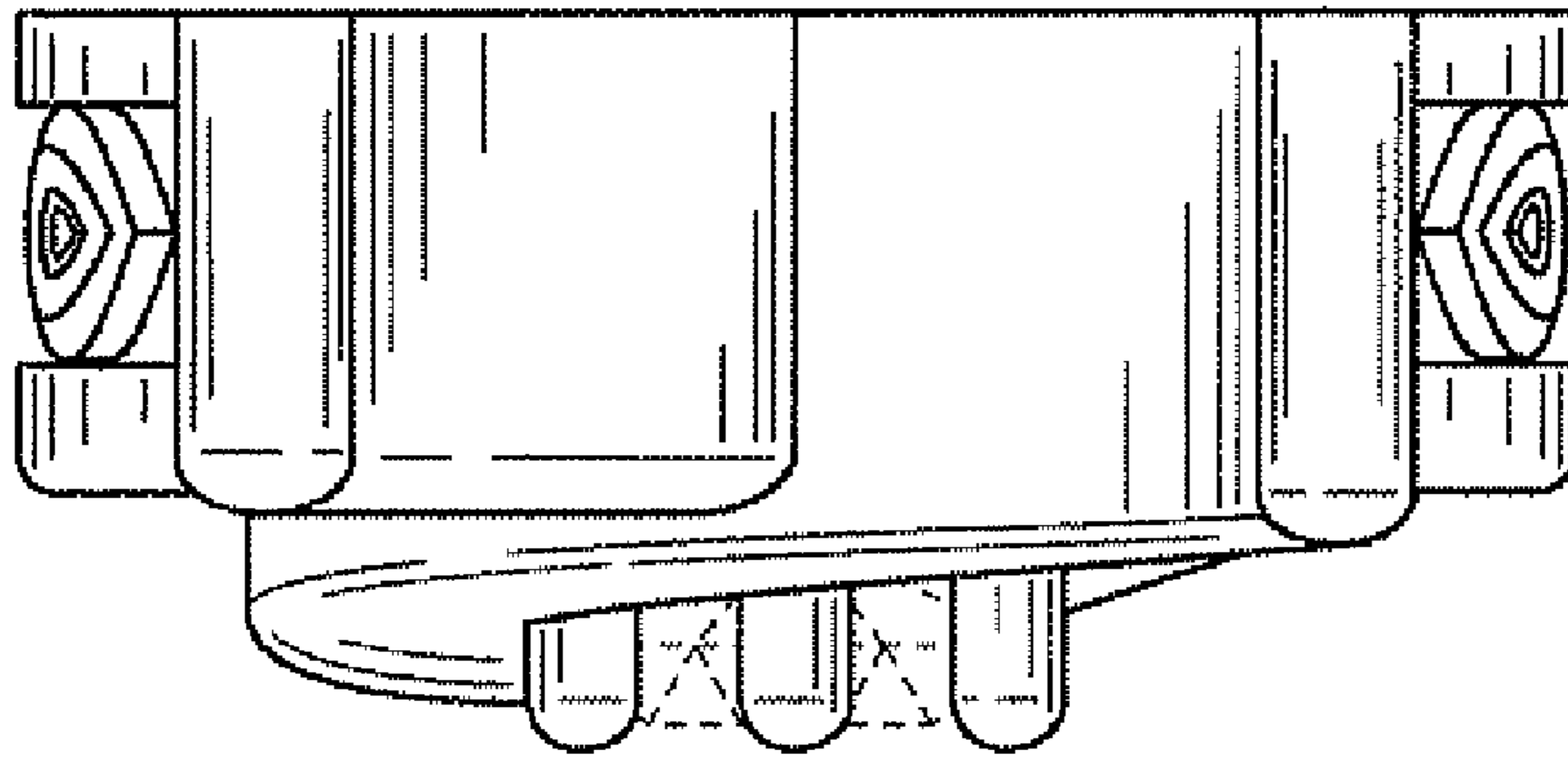
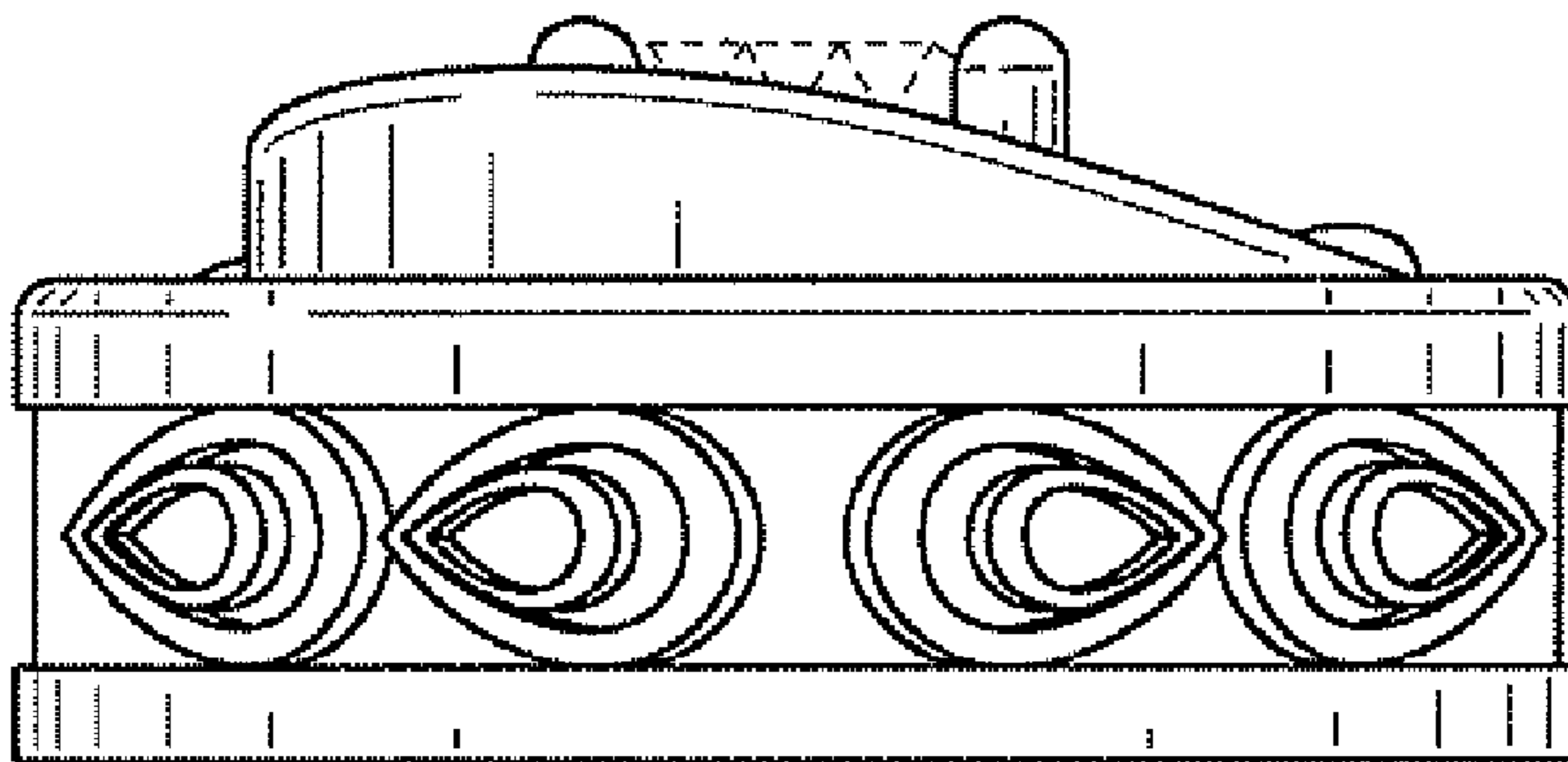

FIG. 4



**FIG. 5**



**FIG. 6**

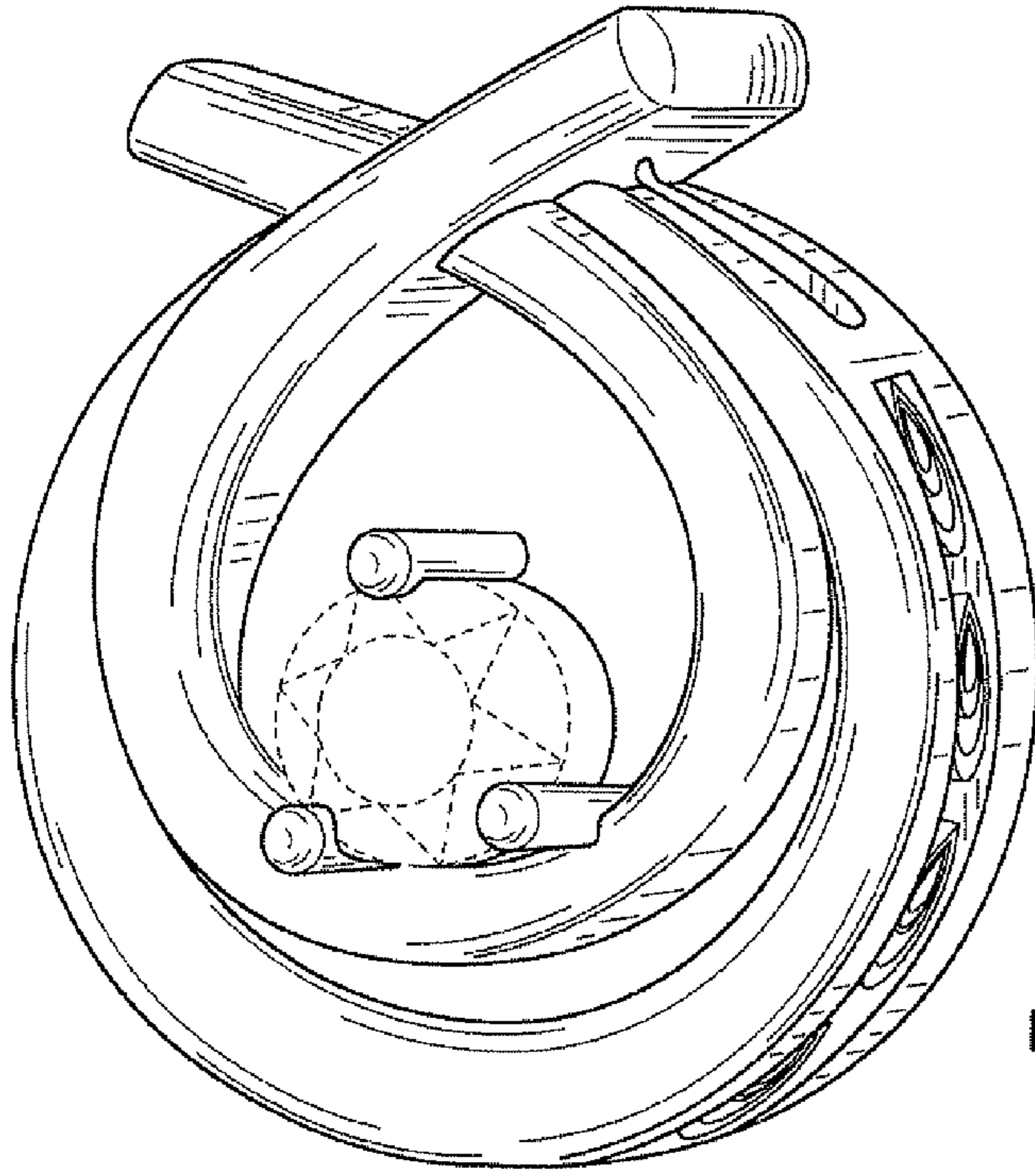

FIG. 7

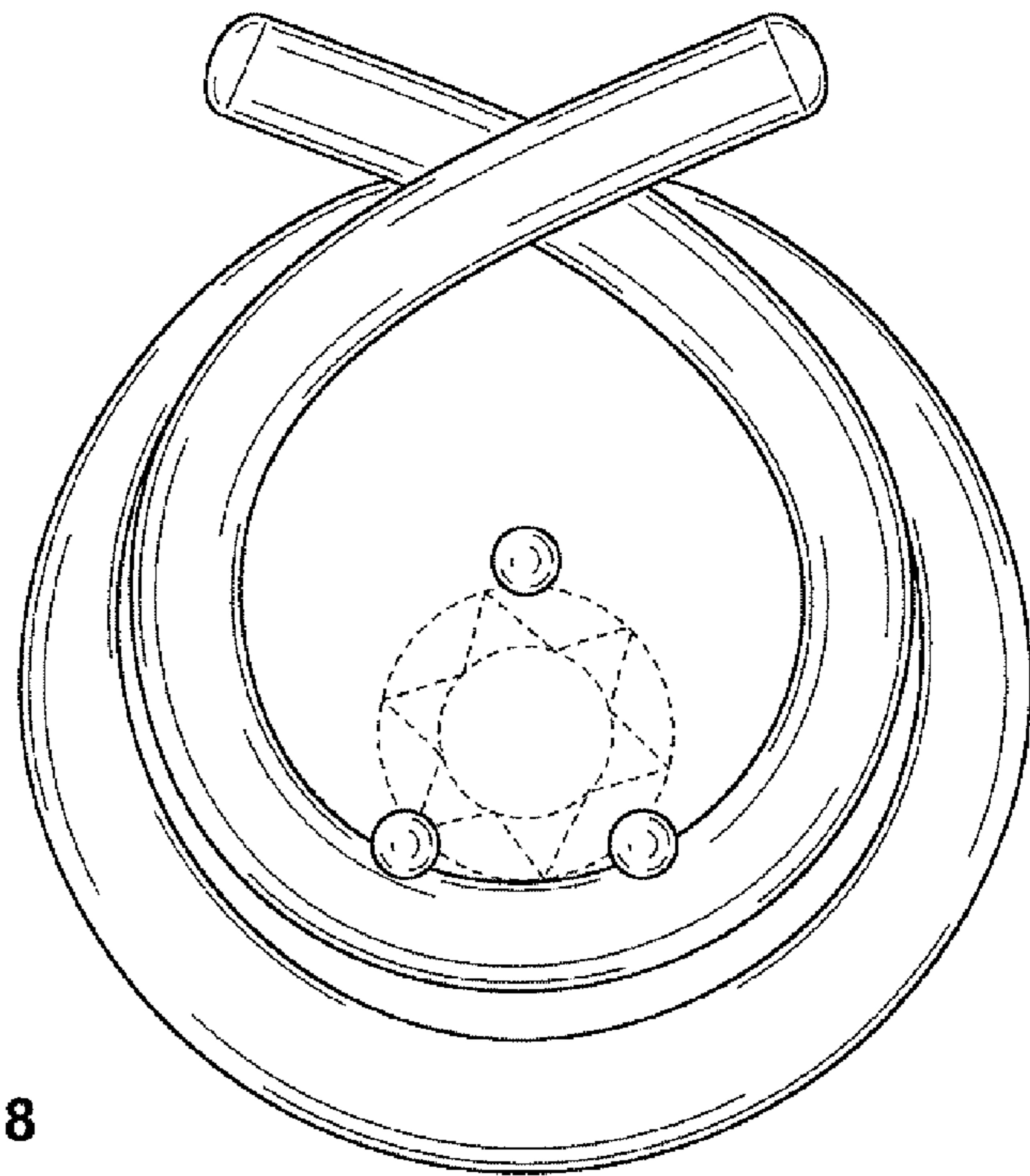

FIG. 8

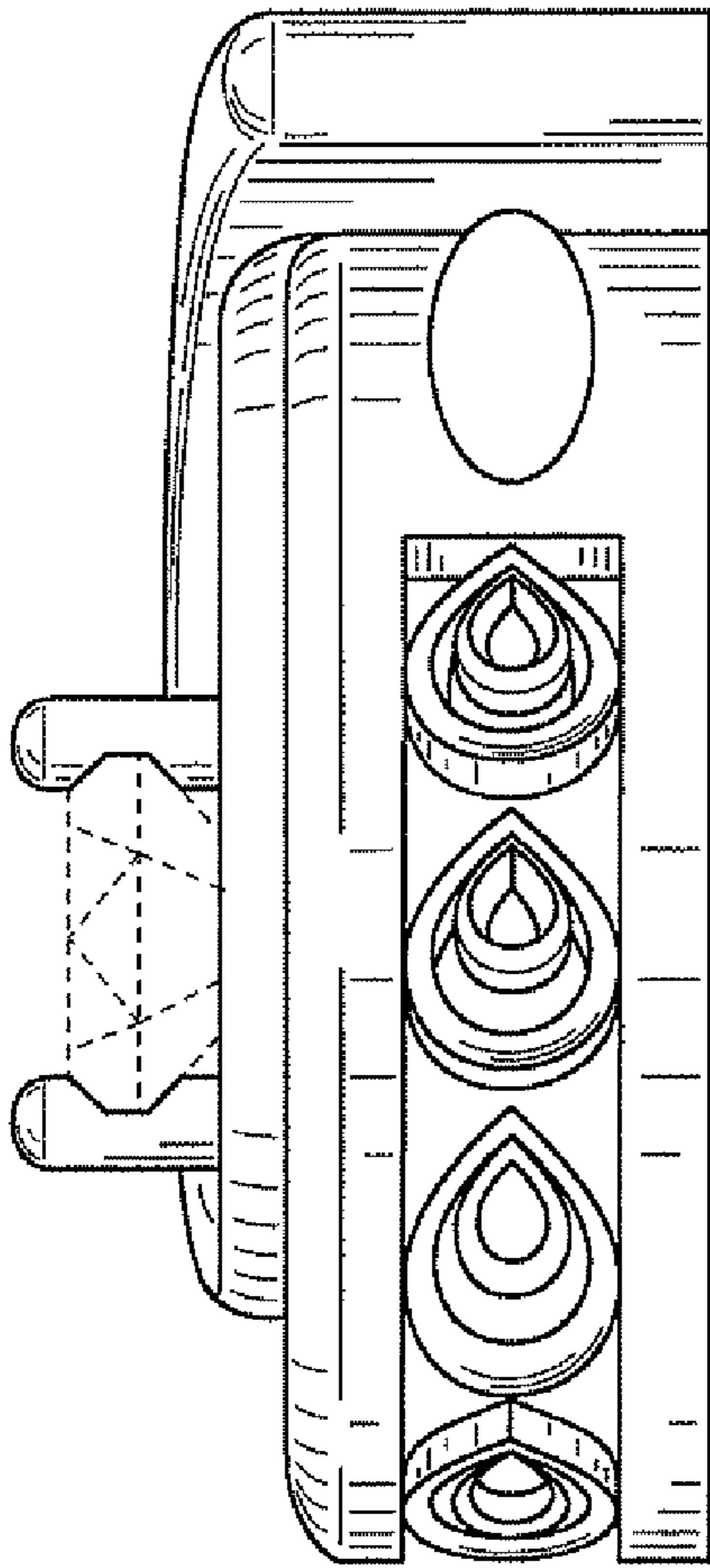

FIG. 9

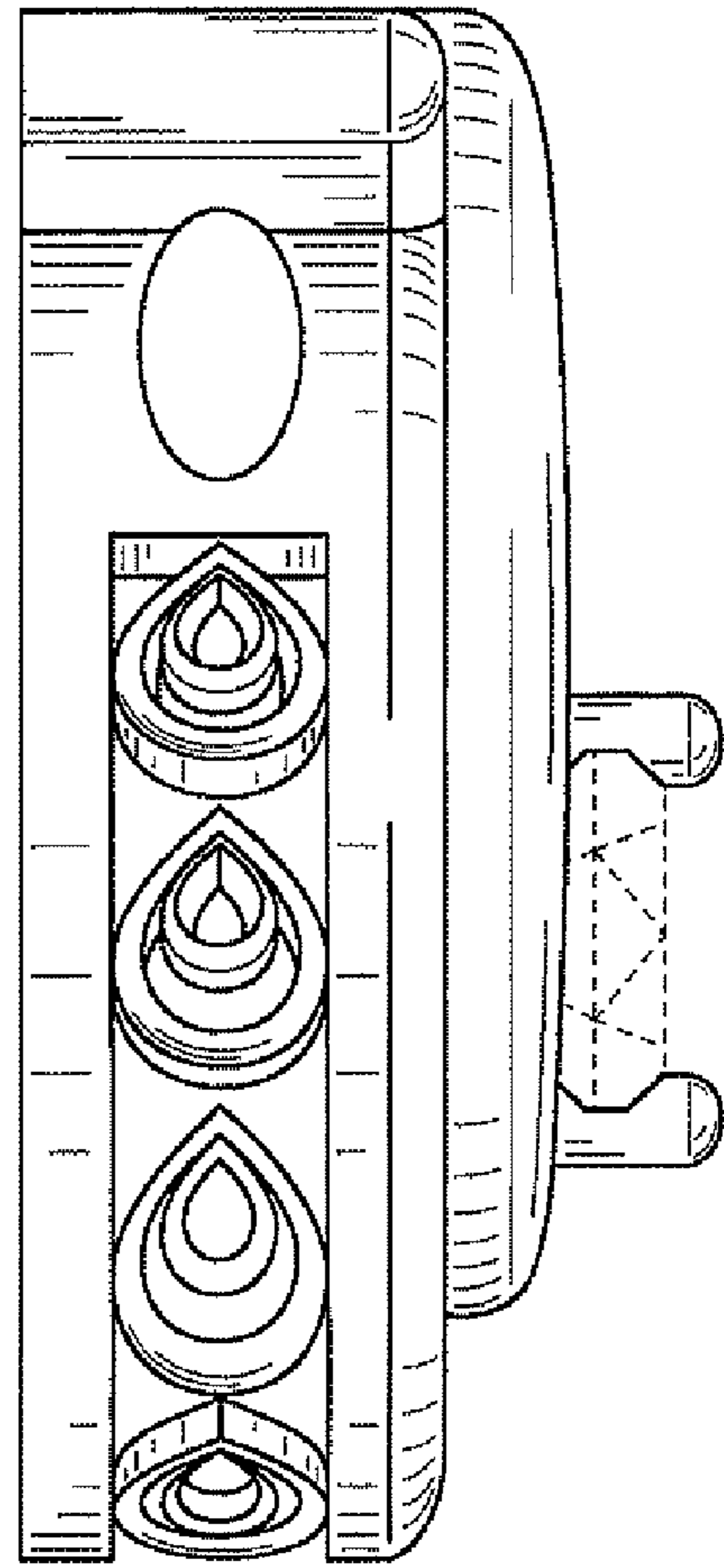

FIG. 10

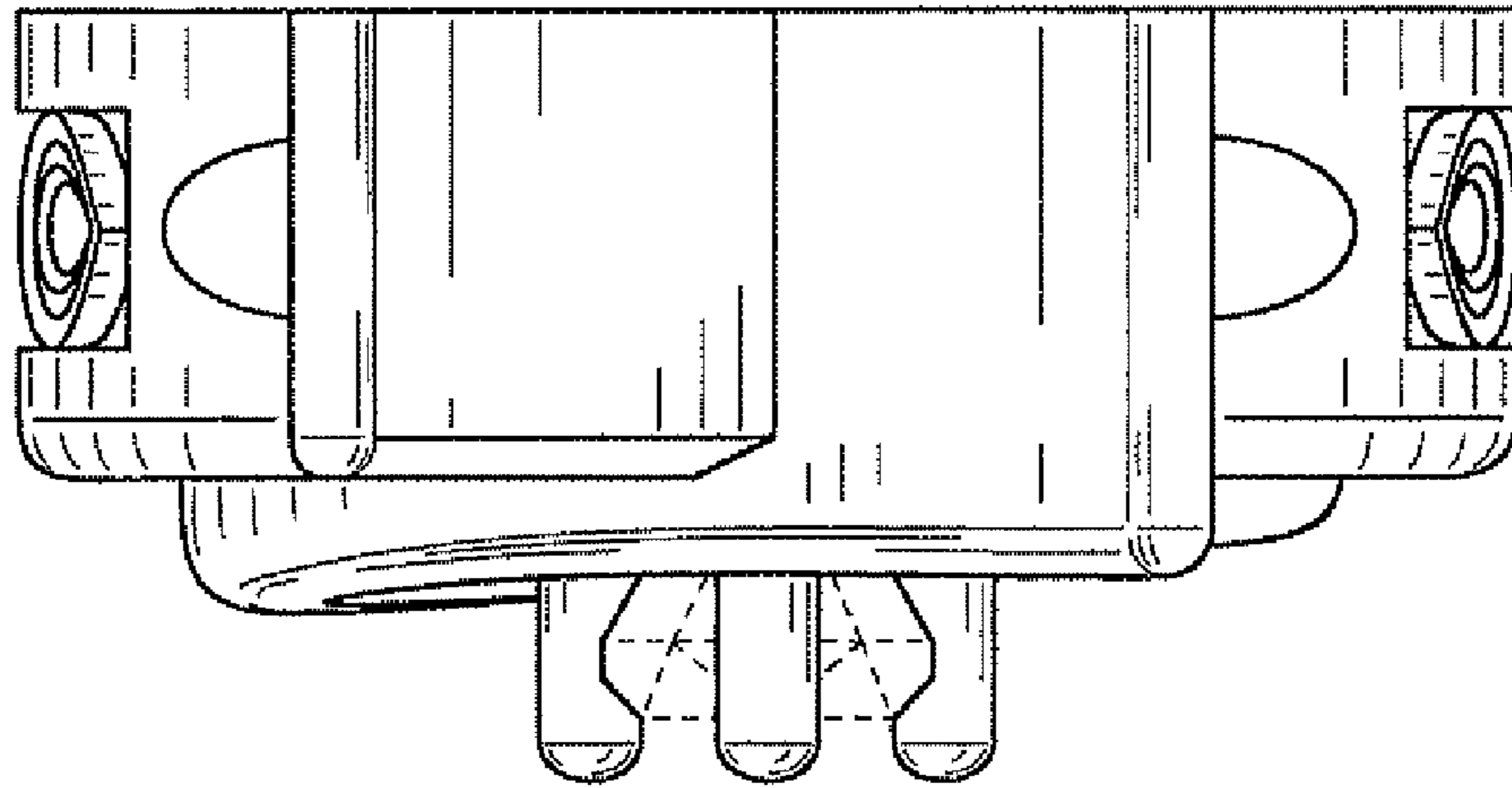

FIG. 11

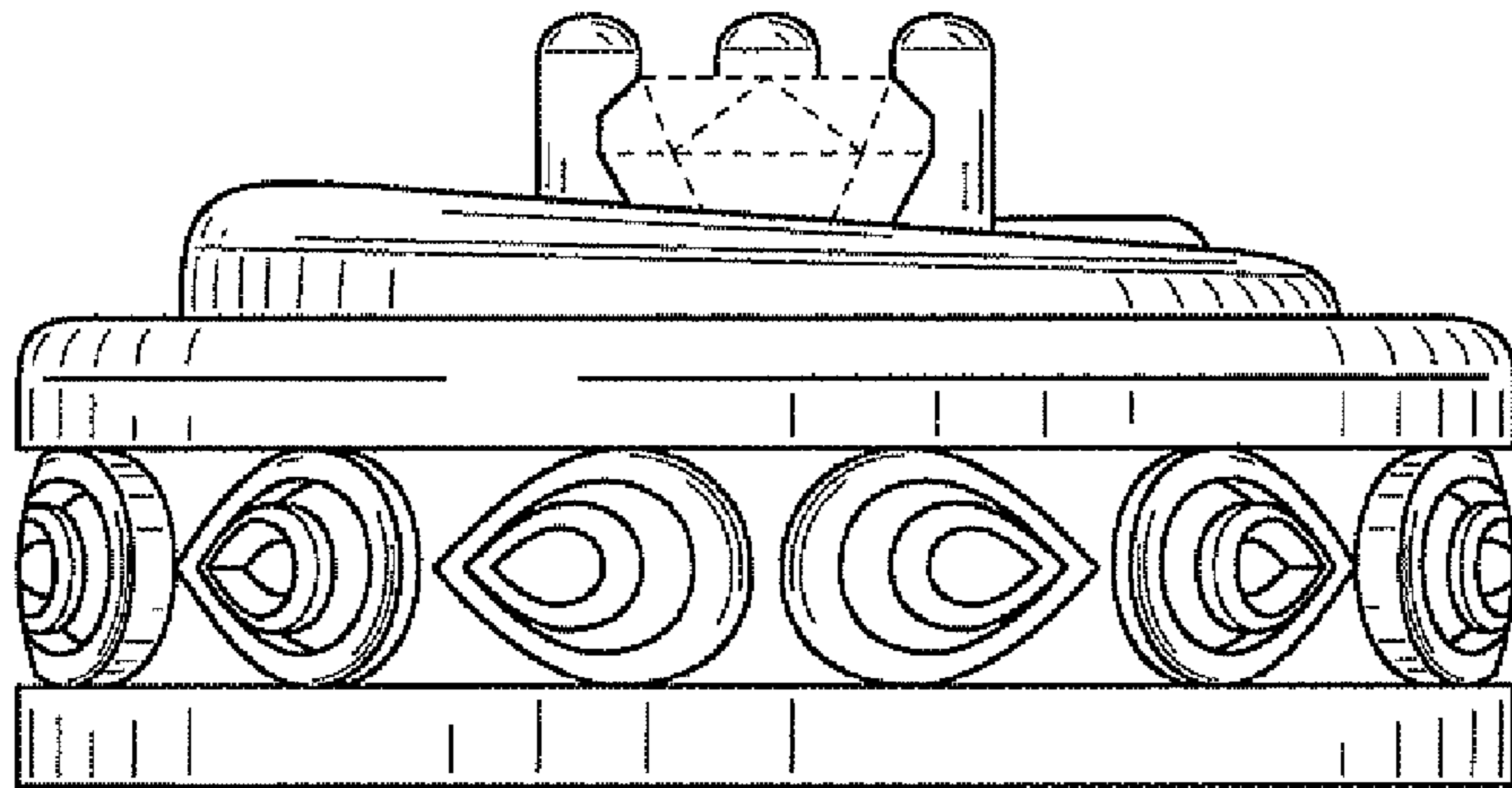

FIG. 12