



US00D621728S

(12) **United States Design Patent**
Au

(10) **Patent No.:** **US D621,728 S**

(45) **Date of Patent:** **** Aug. 17, 2010**

(54) **TURKEY ROAST INDICATOR**

(57) **CLAIM**

(76) **Inventor:** **Sin Ting Au**, Room 714, Kai Fuk Industrial Centre, 1 Wang Tung Street, Kowloon Bay, Kowloon, Hong Kong (CN)

The ornamental design of a turkey roast indicator, as shown and described.

(**) **Term:** **14 Years**

DESCRIPTION

(21) **Appl. No.:** **29/338,335**

FIG. 1 is a front view of the turkey roast indicator in start position;

(22) **Filed:** **Jun. 9, 2009**

FIG. 2 is a rear view of the turkey roast indicator in FIG. 1;

(51) **LOC (9) Cl.** **10-04**

FIG. 3 is a left side view of the turkey roast indicator in FIG. 1;

(52) **U.S. Cl.** **D10/46; D10/52**

FIG. 4 is a right side view of the turkey roast indicator in FIG. 1;

(58) **Field of Classification Search** **D7/368, D7/323, 387, 402, 213; D10/46, 52, 57; 116/218, 101, 217, 202; 99/421 TP; 426/88; 374/104, 160, 416, 155, E1.002**

FIG. 5 is a top view of the turkey roast indicator in FIG. 1;

FIG. 6 is a bottom view of the turkey roast indicator in FIG. 1;

See application file for complete search history.

FIG. 7 is a front perspective view of the turkey roast indicator in FIG. 1;

FIG. 8 is a front view of the turkey roast indicator in the cooked position;

(56) **References Cited**

U.S. PATENT DOCUMENTS

| | | | | | |
|-----------|-----|---------|-----------------|-------|---------|
| 3,140,611 | A * | 7/1964 | Kliewer | | 374/104 |
| 3,479,876 | A * | 11/1969 | Kliewer | | 374/104 |
| 3,548,780 | A * | 12/1970 | Kliewer | | 116/218 |
| 3,693,579 | A * | 9/1972 | Kliewer | | 116/218 |
| 5,323,730 | A * | 6/1994 | Ou-Yang | | 116/218 |
| 5,487,352 | A * | 1/1996 | Williams et al. | | 116/218 |

FIG. 9 is a rear view of the turkey roast indicator in FIG. 8;

FIG. 10 is a left side view of the turkey roast indicator in FIG. 8;

FIG. 11 is a right side view of the turkey roast indicator in FIG. 8;

FIG. 12 is a top view of the turkey roast indicator in FIG. 8;

FIG. 13 is a bottom view of the turkey roast indicator in FIG. 8; and,

* cited by examiner

FIG. 14 is a front perspective view of the turkey roast indicator in FIG. 8.

Primary Examiner—Terry A Wallace

(74) *Attorney, Agent, or Firm*—Akerman Senterfitt

1 Claim, 14 Drawing Sheets

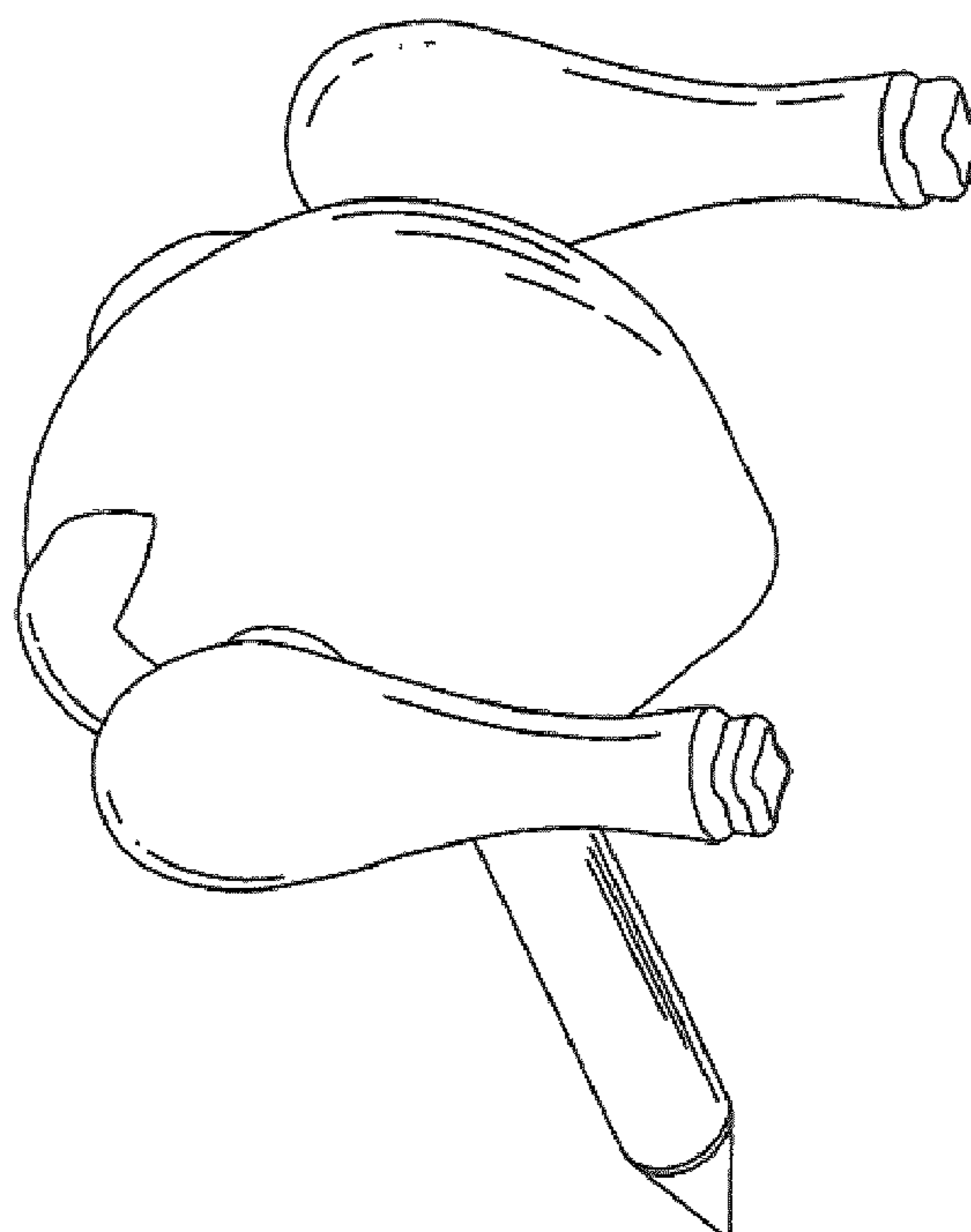

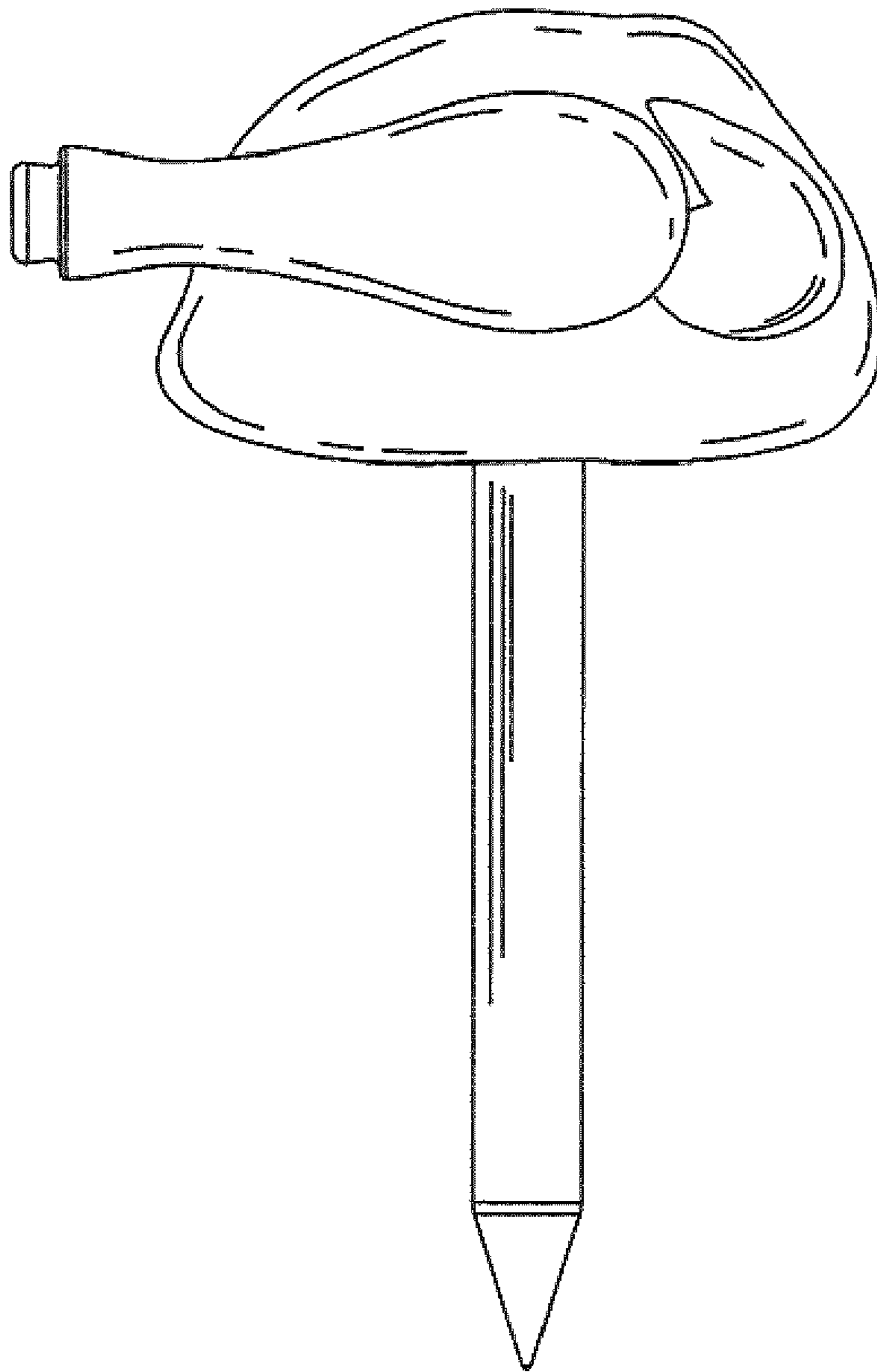

FIG. 1

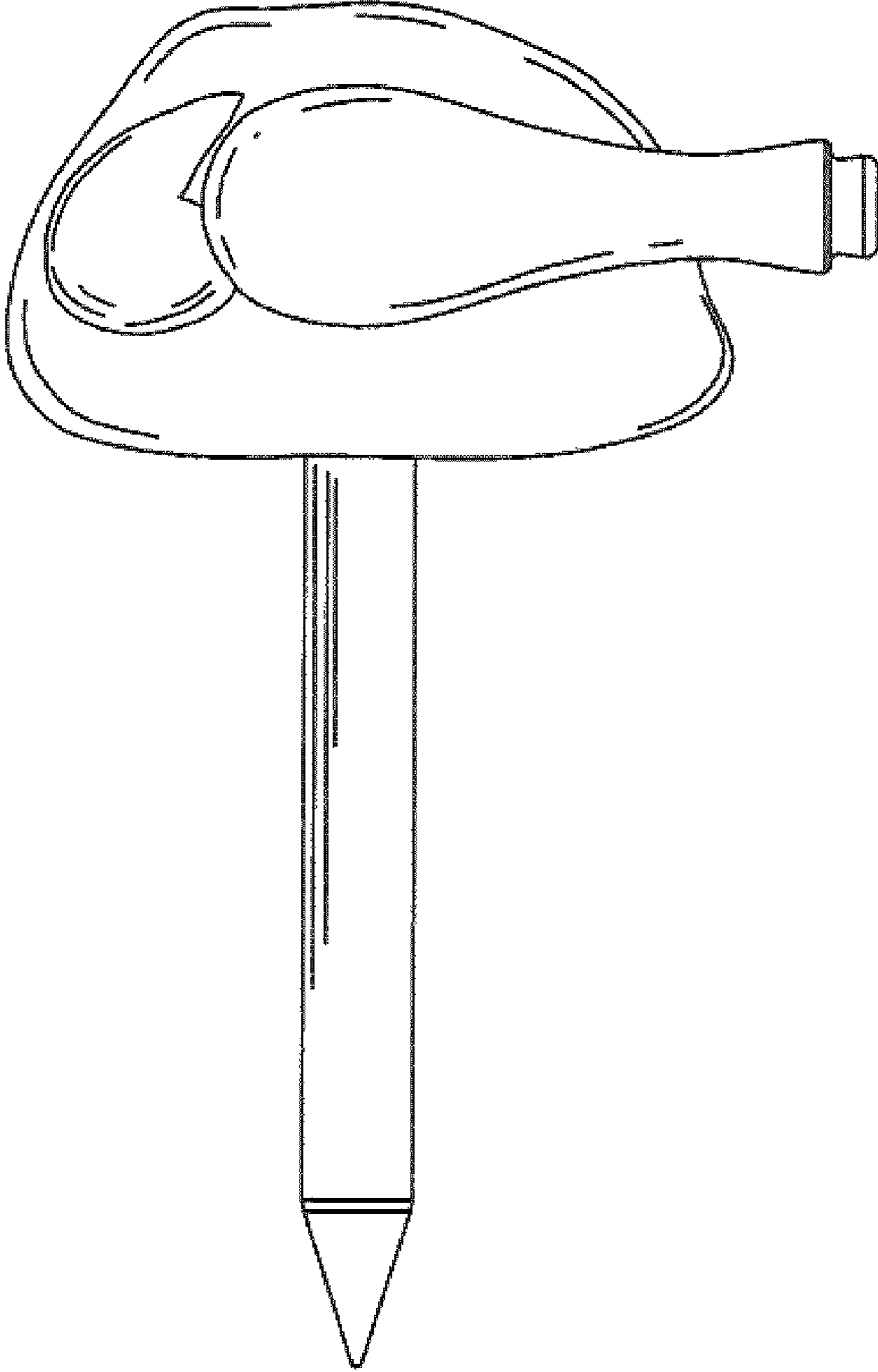

FIG. 2

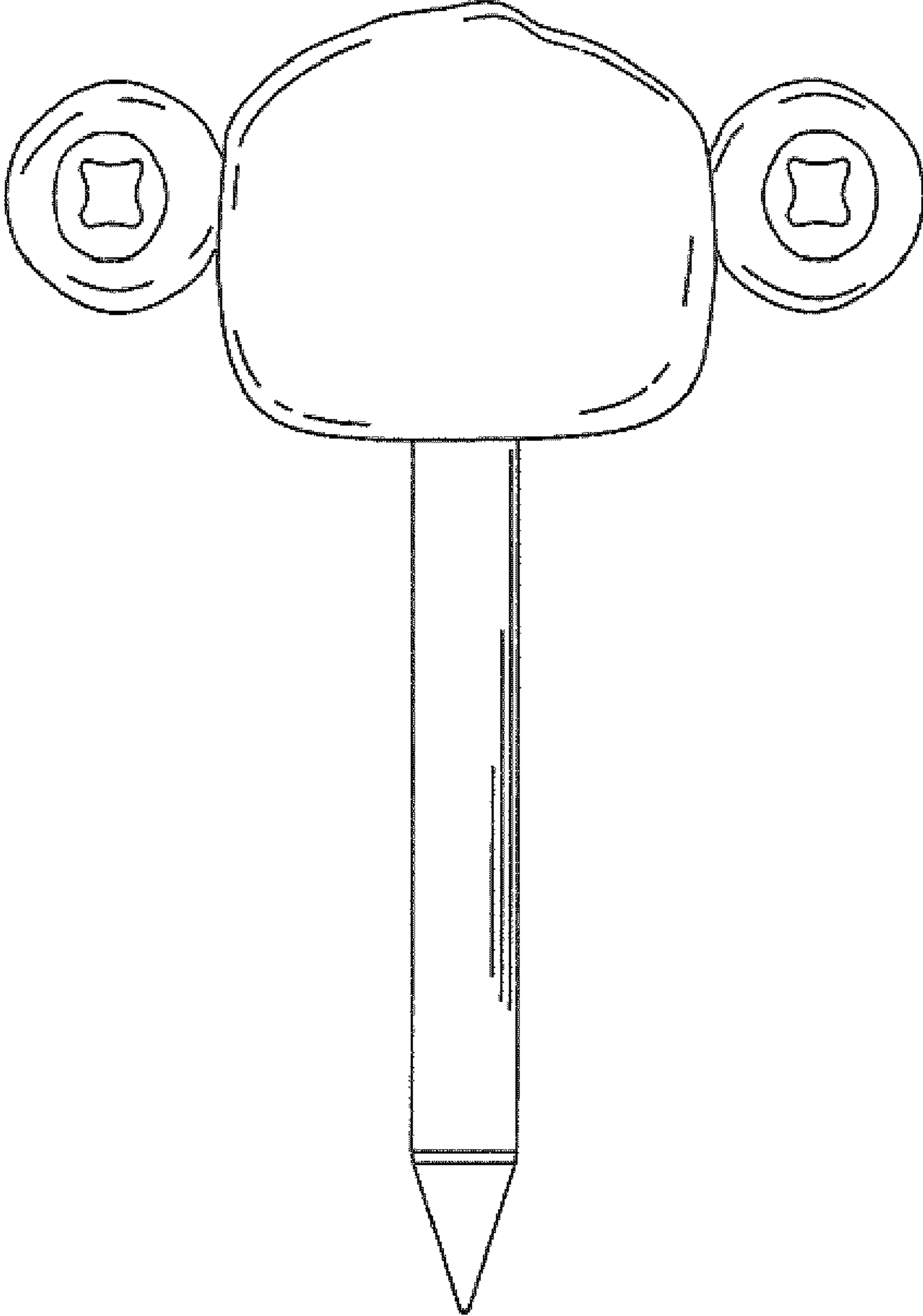

FIG. 3

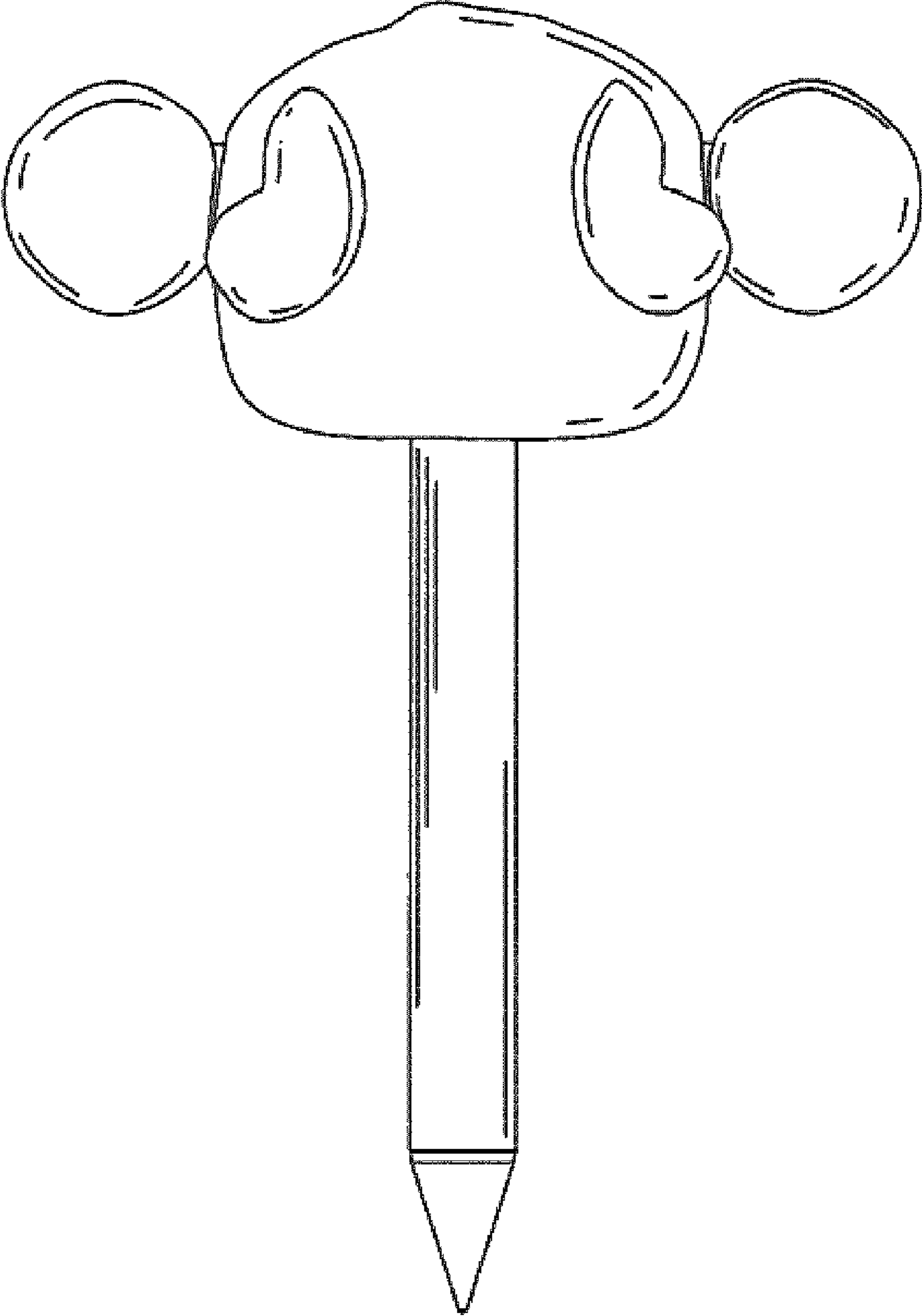

FIG. 4

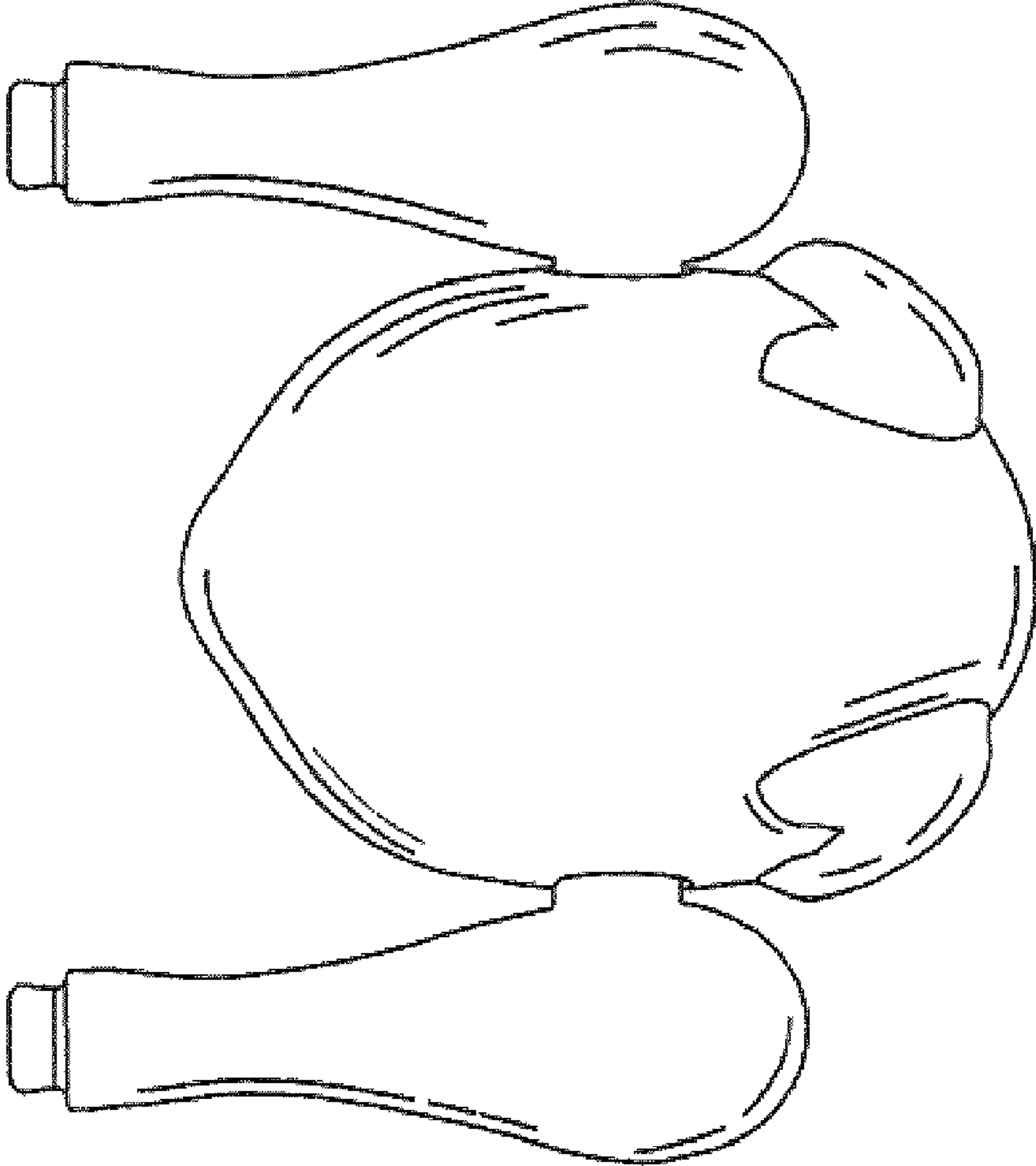

FIG. 5

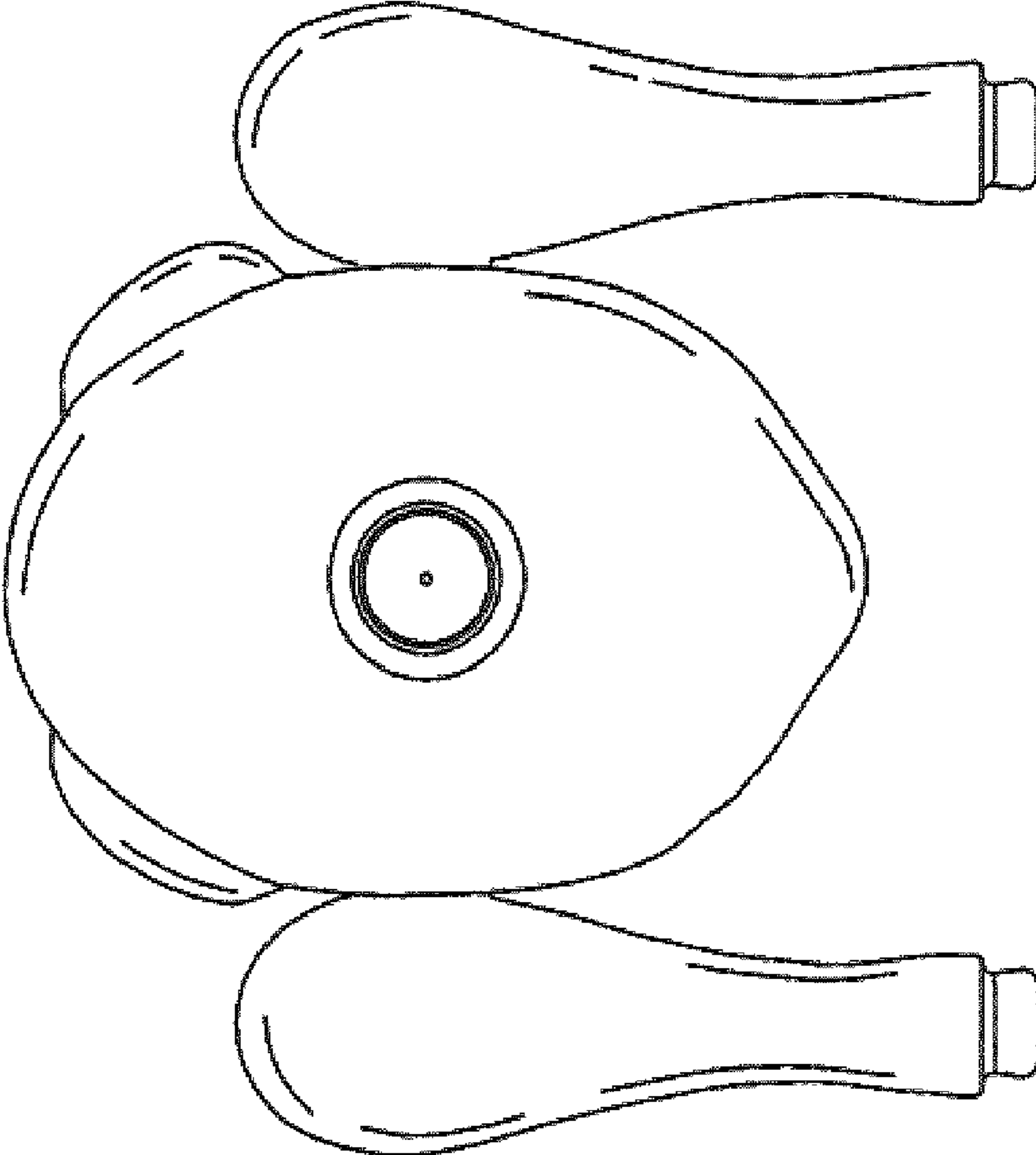

FIG. 6

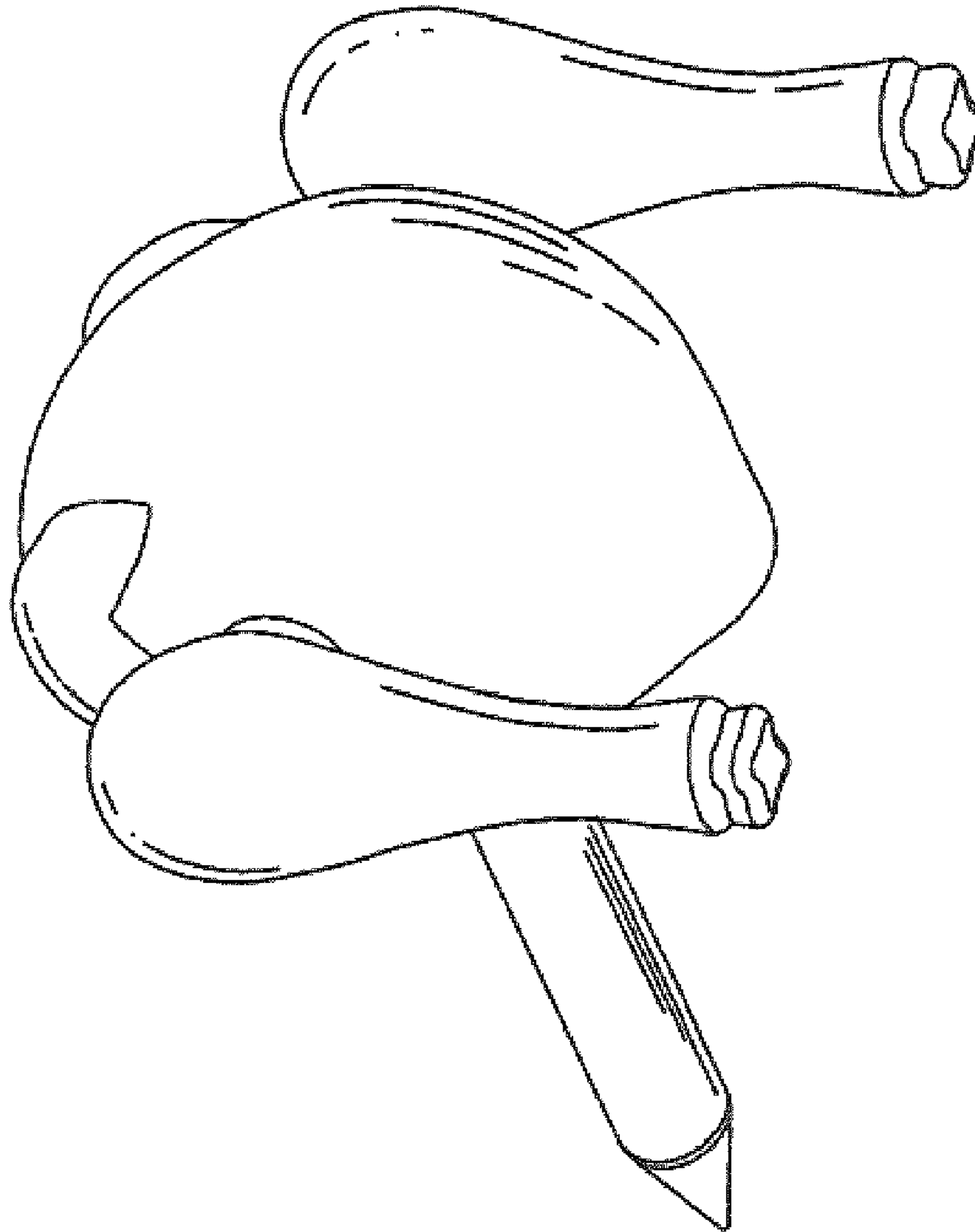

FIG. 7

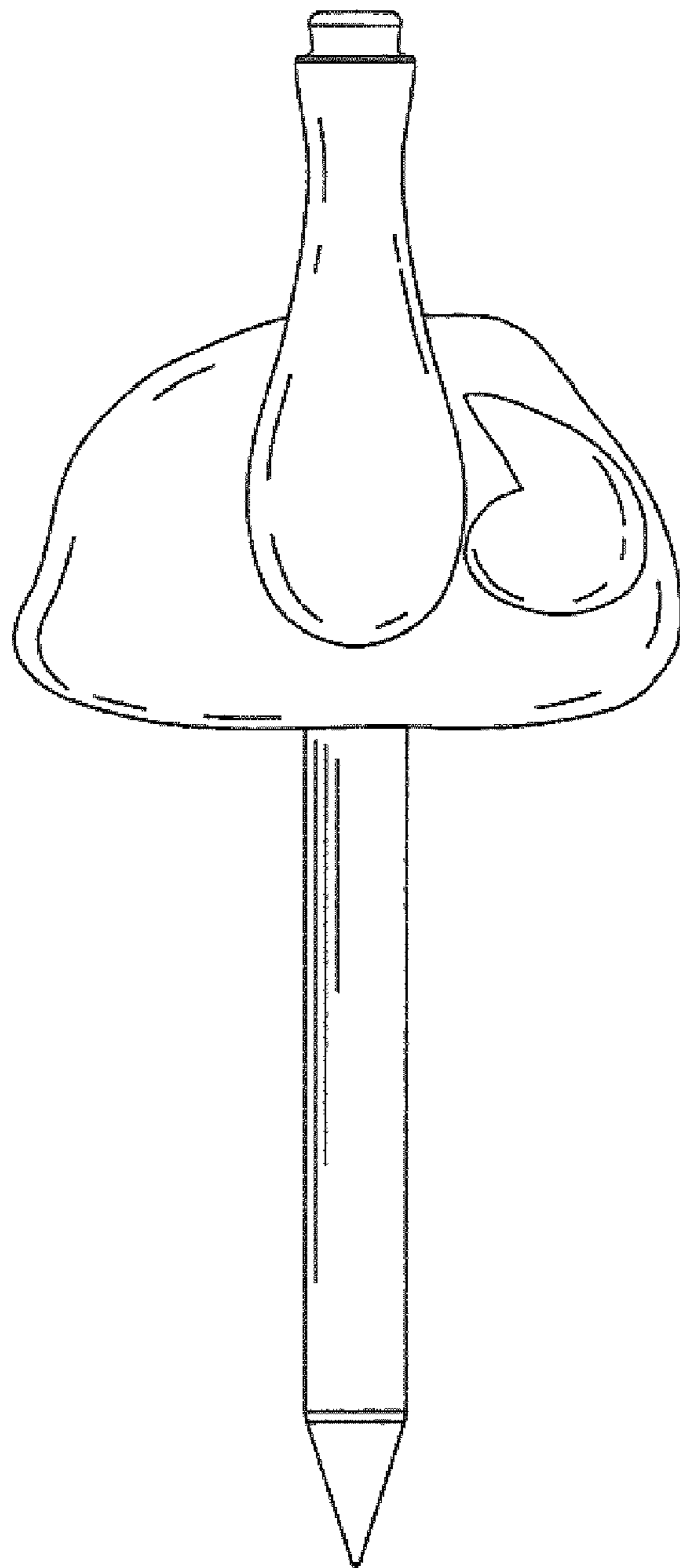

FIG. 8

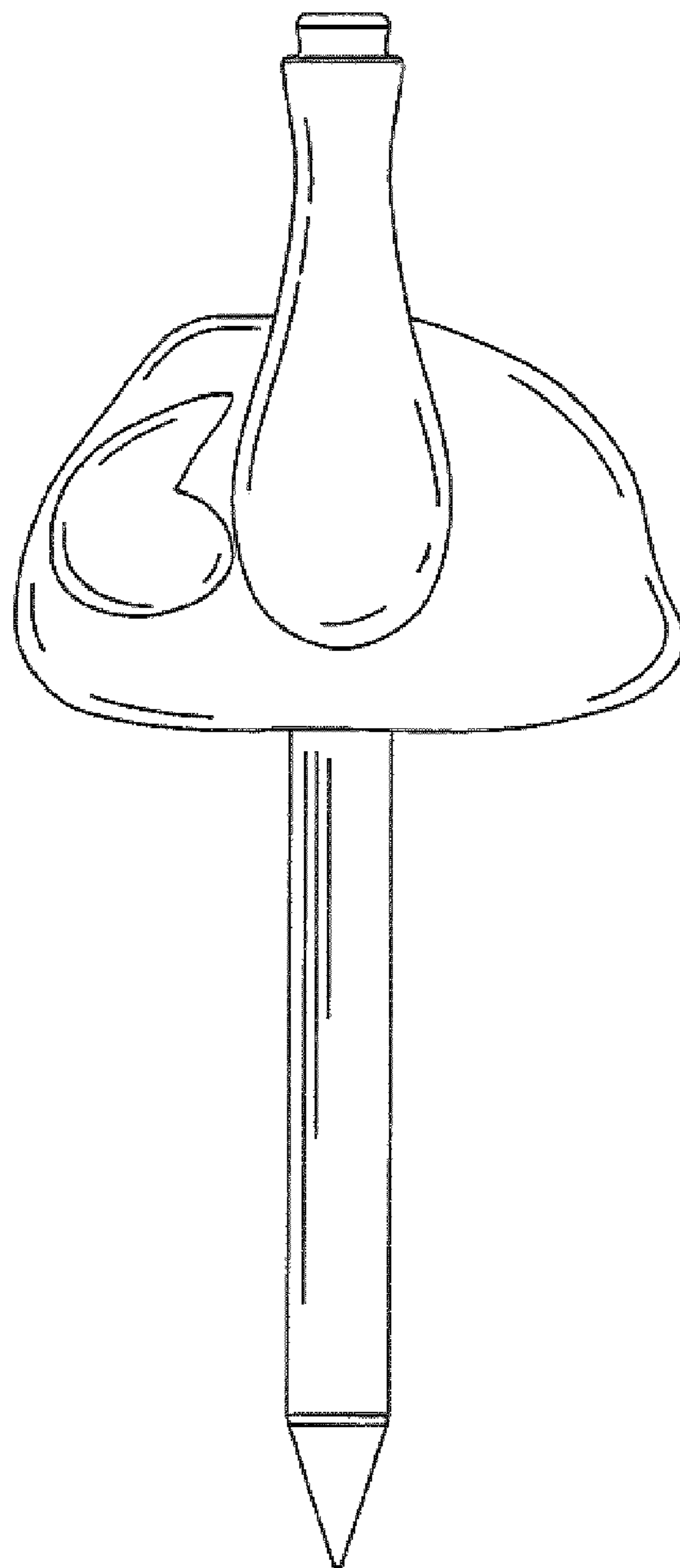

FIG. 9

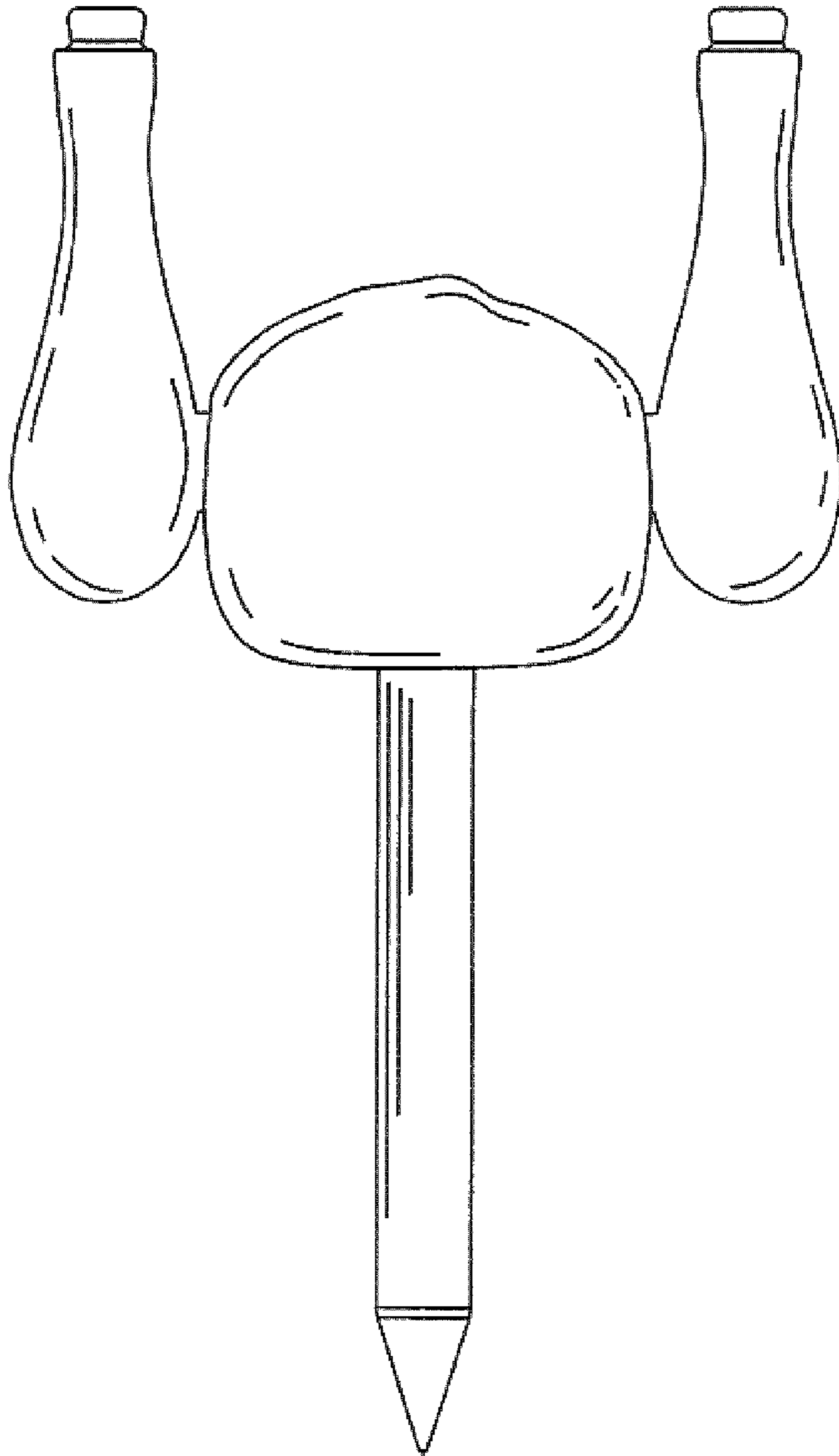

FIG. 10

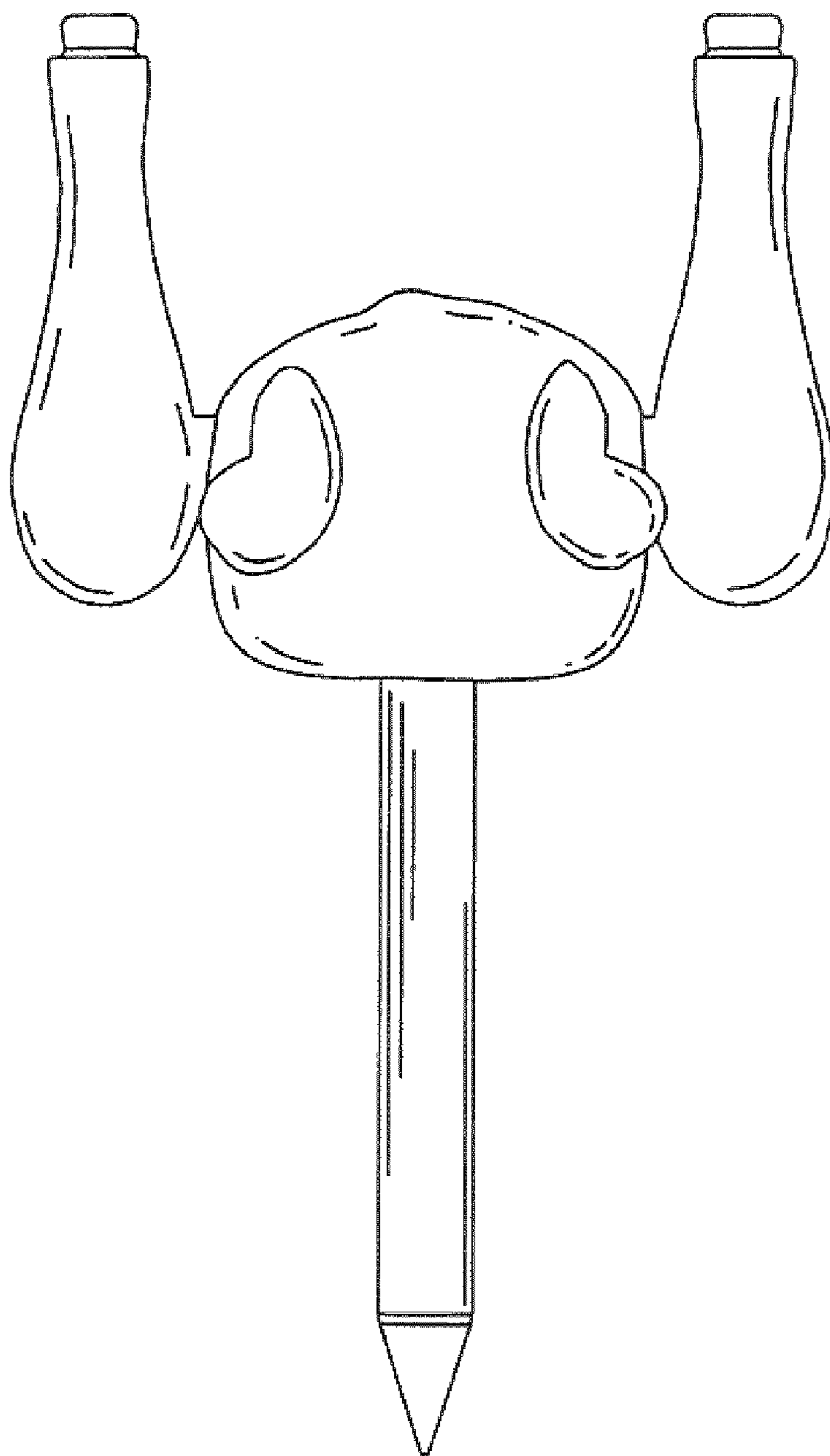

FIG. 11

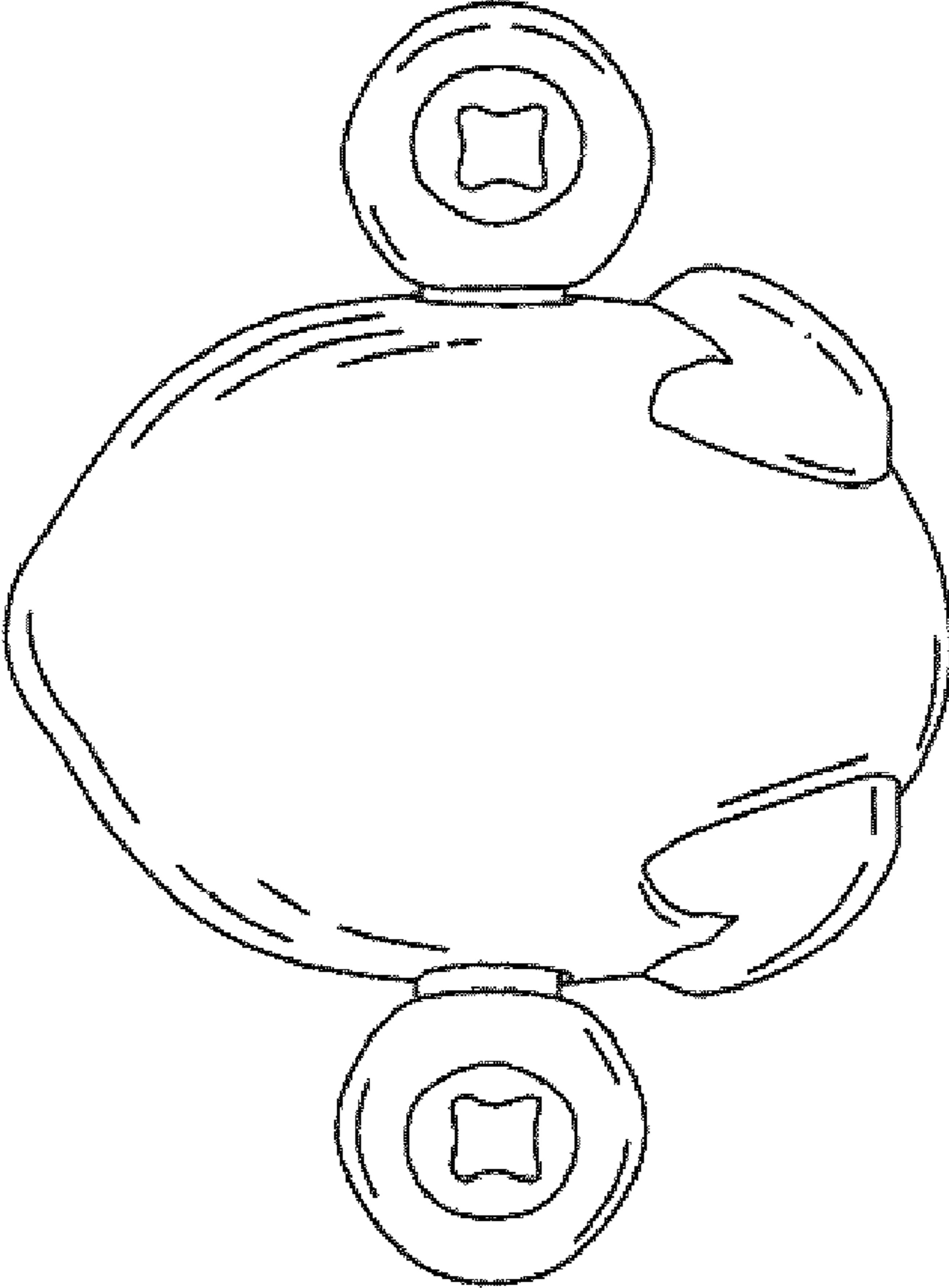

FIG. 12

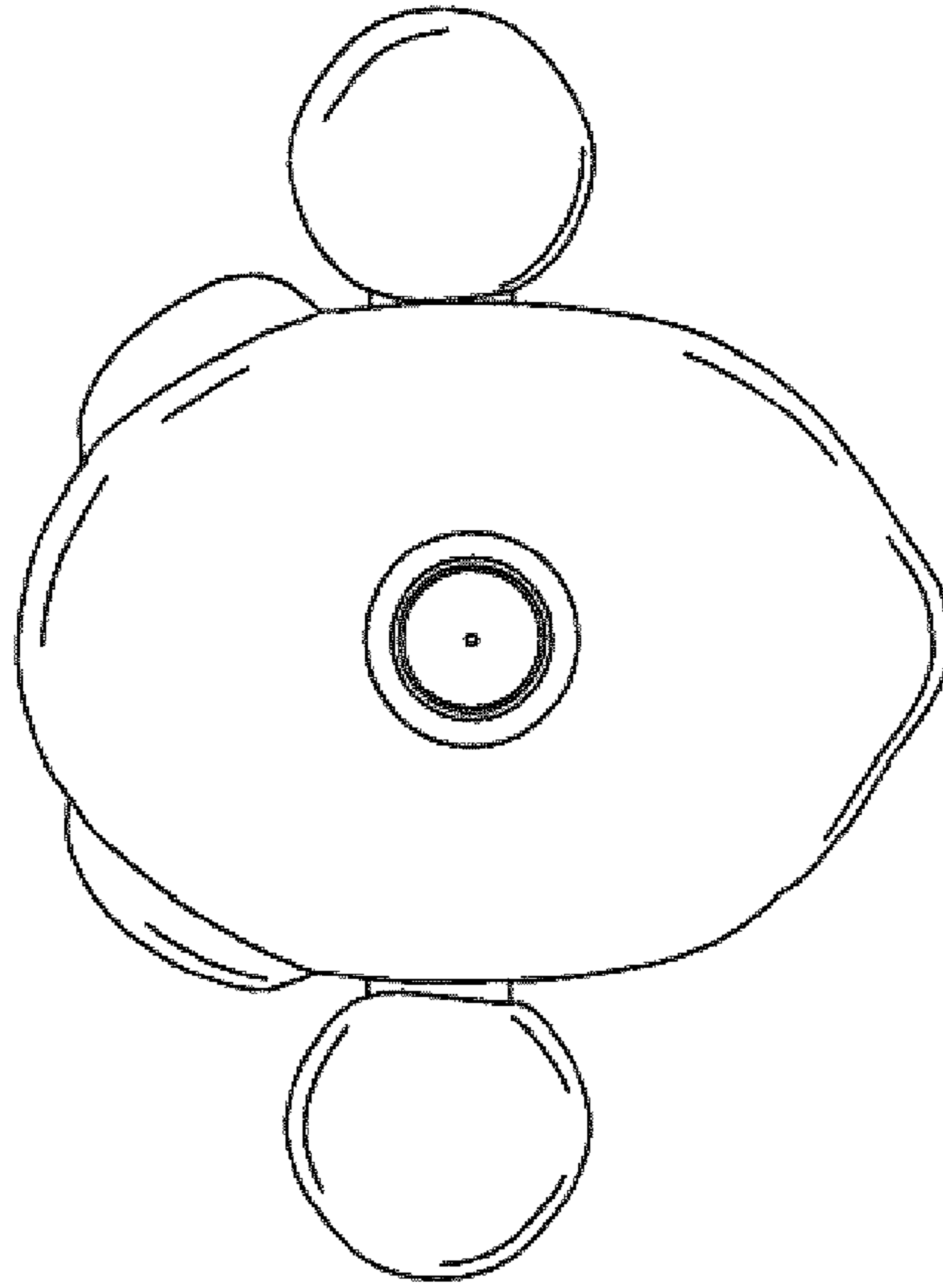

FIG. 13

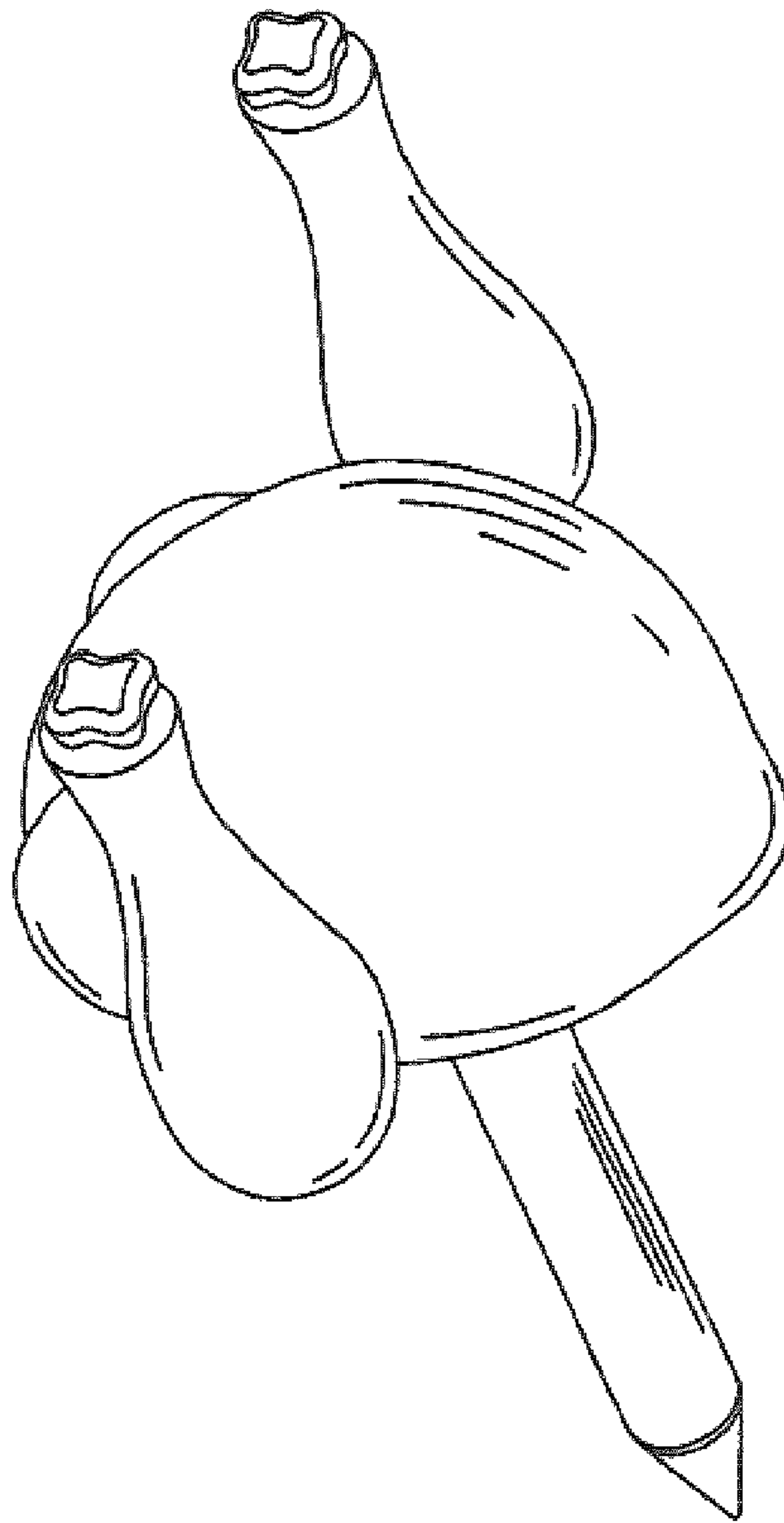

FIG. 14