



US00D621646S

(12) **United States Design Patent**  
**De Bonis**

(10) **Patent No.:** **US D621,646 S**

(45) **Date of Patent:** **\*\* Aug. 17, 2010**

(54) **TOILET PAPER HOLDER**

D573,821 S \* 7/2008 Rubin et al. .... D6/523

(75) Inventor: **Michele De Bonis**, Heusden-Zolder (BE)

\* cited by examiner

(73) Assignee: **Brabantia Nederland B.V.**, XK  
Valkenswaard (NL)

*Primary Examiner*—Brian N Vinson

(74) *Attorney, Agent, or Firm*—Abelman, Frayne & Schwab

(\*\*) Term: **14 Years**

(57) **CLAIM**

(21) Appl. No.: **29/315,740**

The ornamental design for a toilet paper holder, as shown and described.

(22) Filed: **Jul. 16, 2009**

**DESCRIPTION**

(30) **Foreign Application Priority Data**

Jun. 12, 2009 (EM) ..... 001545948-0001

FIG. 1 is a top, front right side perspective view of the toilet paper holder with a cover in a lowered position showing the new design;

(51) **LOC (9) Cl.** ..... **23-02**

(52) **U.S. Cl.** ..... **D6/523**

FIG. 2 is a front elevational view thereof;

(58) **Field of Classification Search** ..... D6/515-524,  
D6/546-550; D8/300, 303, 315-321; 108/28-29;  
211/13.1, 16, 60.1, 86.01, 87.01, 88.01, 88.04,  
211/100, 105.1, 105.2, 123, 181.1, 182; 248/175,  
248/176.1, 251, 302; 242/570, 590, 595-598

FIG. 3 is a left side elevational view thereof;

FIG. 4 is a rear elevational view thereof;

FIG. 5 is a right side elevational view thereof;

FIG. 6 is a top plan view thereof;

FIG. 7 is a bottom plan view thereof; and,

See application file for complete search history.

FIG. 8 is a top, front right side perspective view of the toilet paper holder with the cover in a raised position.

The broken lines showing structural features are included for the purpose of illustrating non-claimed subject matter and form no part of the claimed design.

(56) **References Cited**

**U.S. PATENT DOCUMENTS**

D512,591 S *	12/2005	Ferrer Beltran	.....	D6/523
D520,787 S *	5/2006	Ferrer Beltran	.....	D6/523
D521,288 S *	5/2006	Barry	.....	D6/523
D522,294 S *	6/2006	Ferrer Beltran	.....	D6/523

**1 Claim, 4 Drawing Sheets**

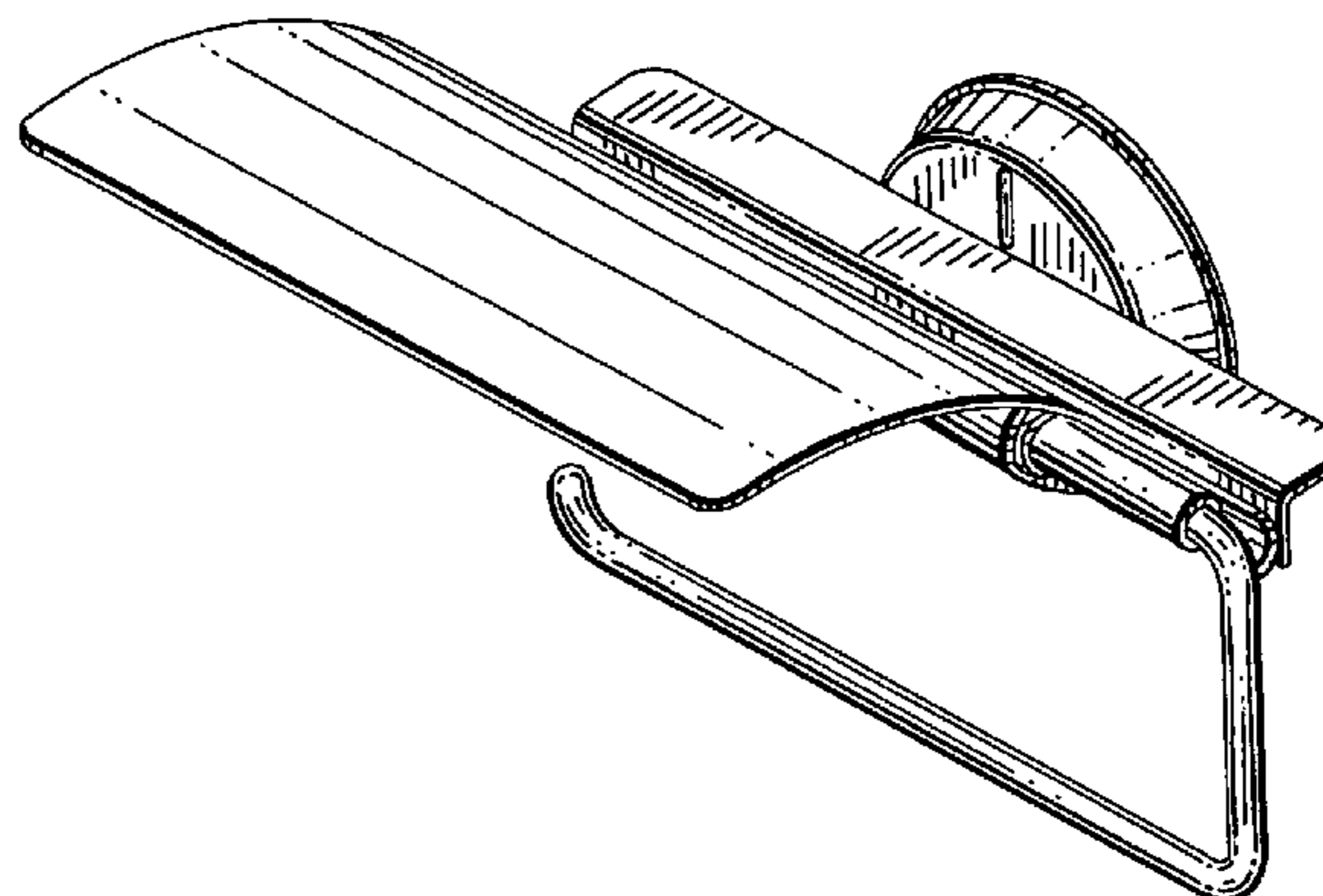
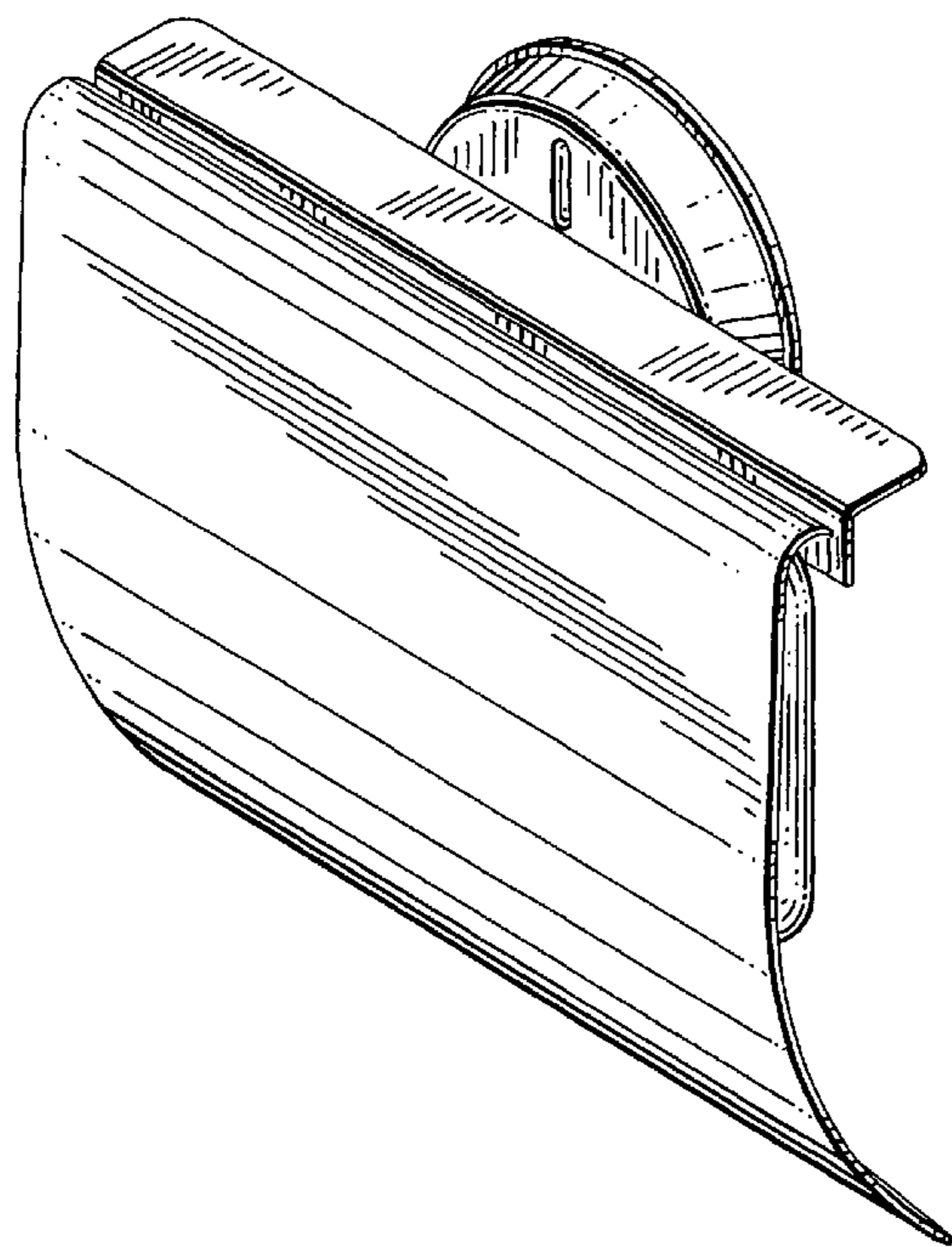

FIG. 2

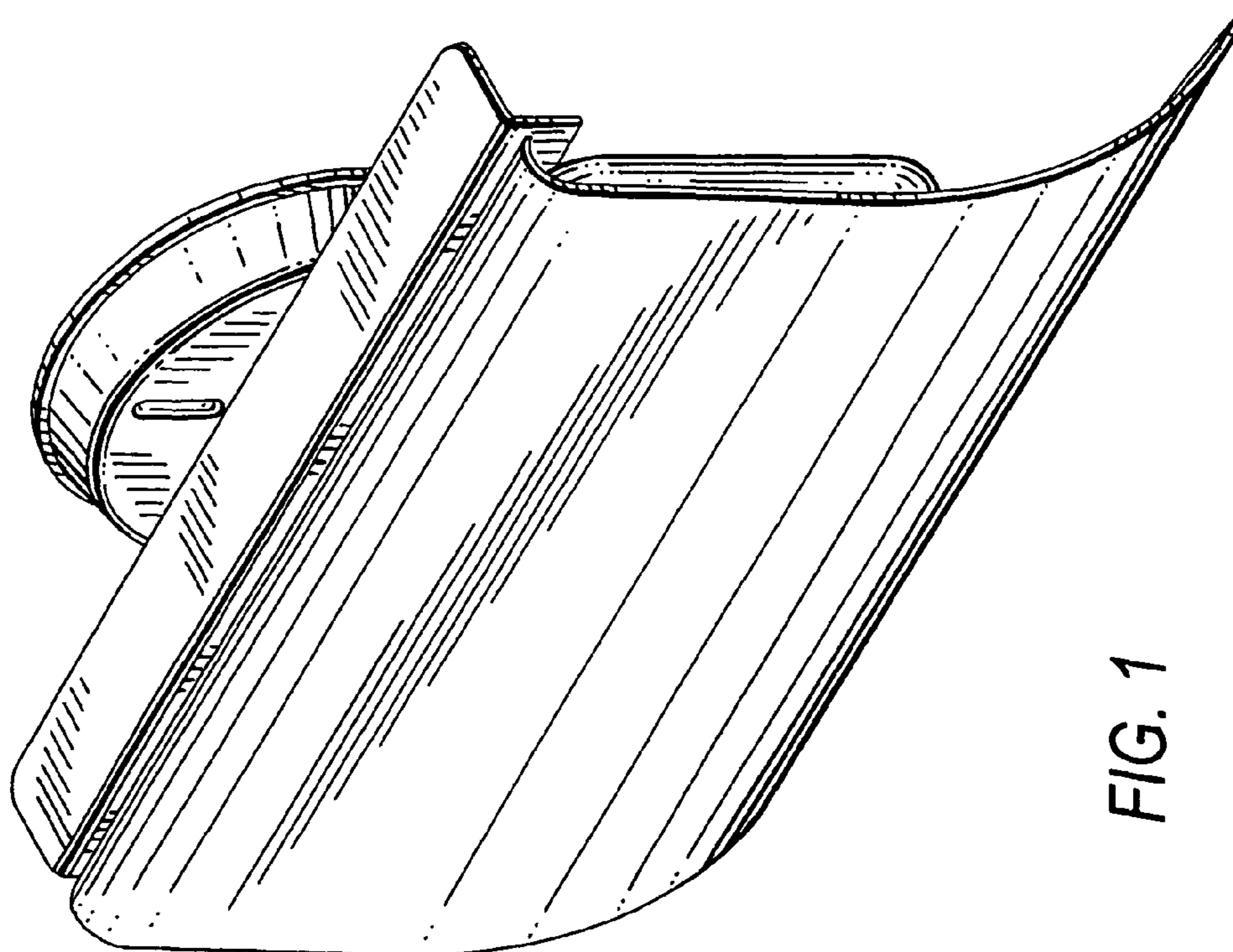
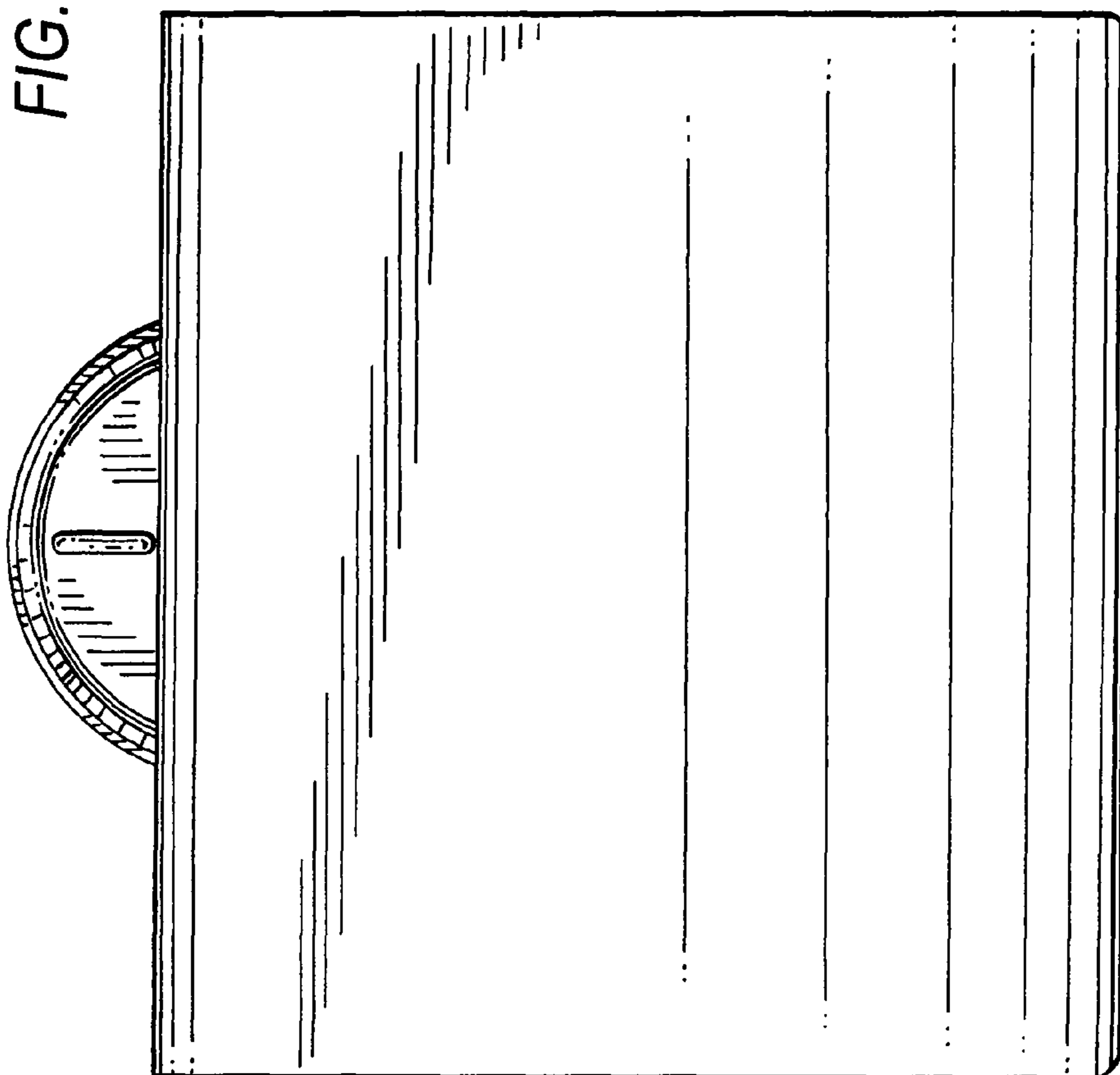

FIG. 1

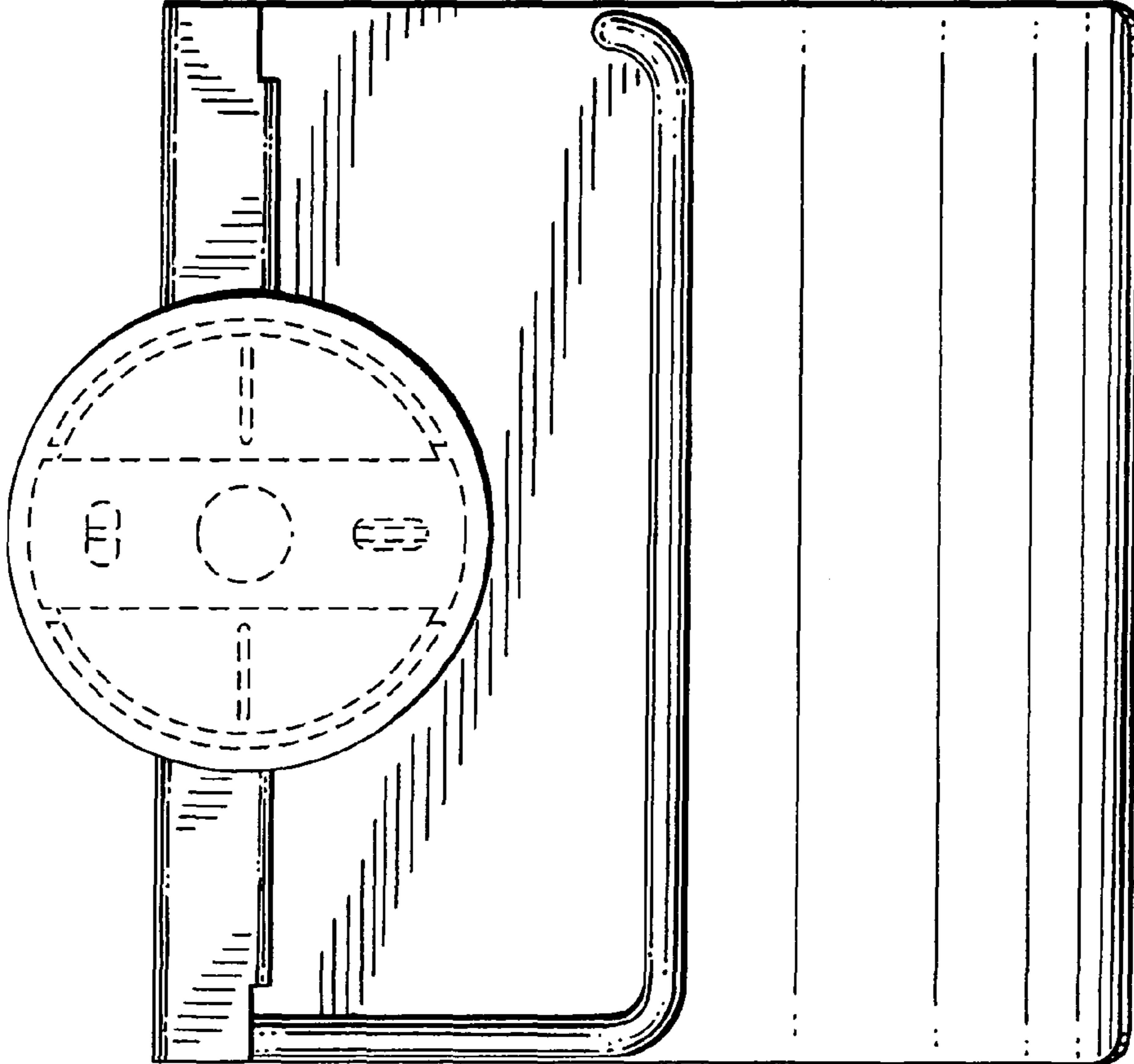

FIG. 4

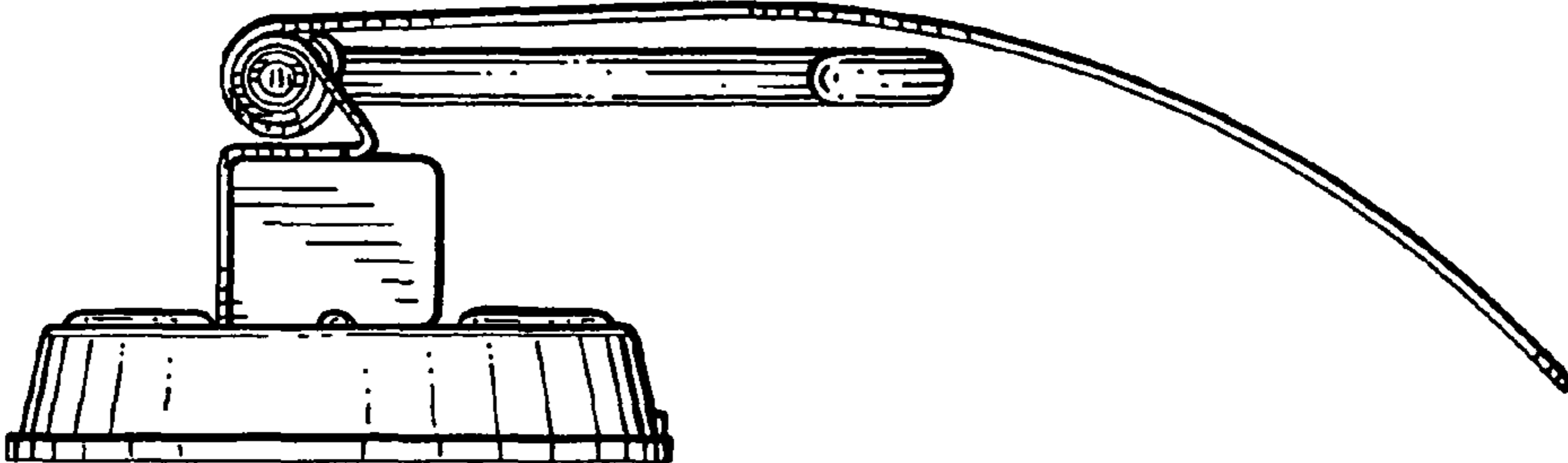

FIG. 3

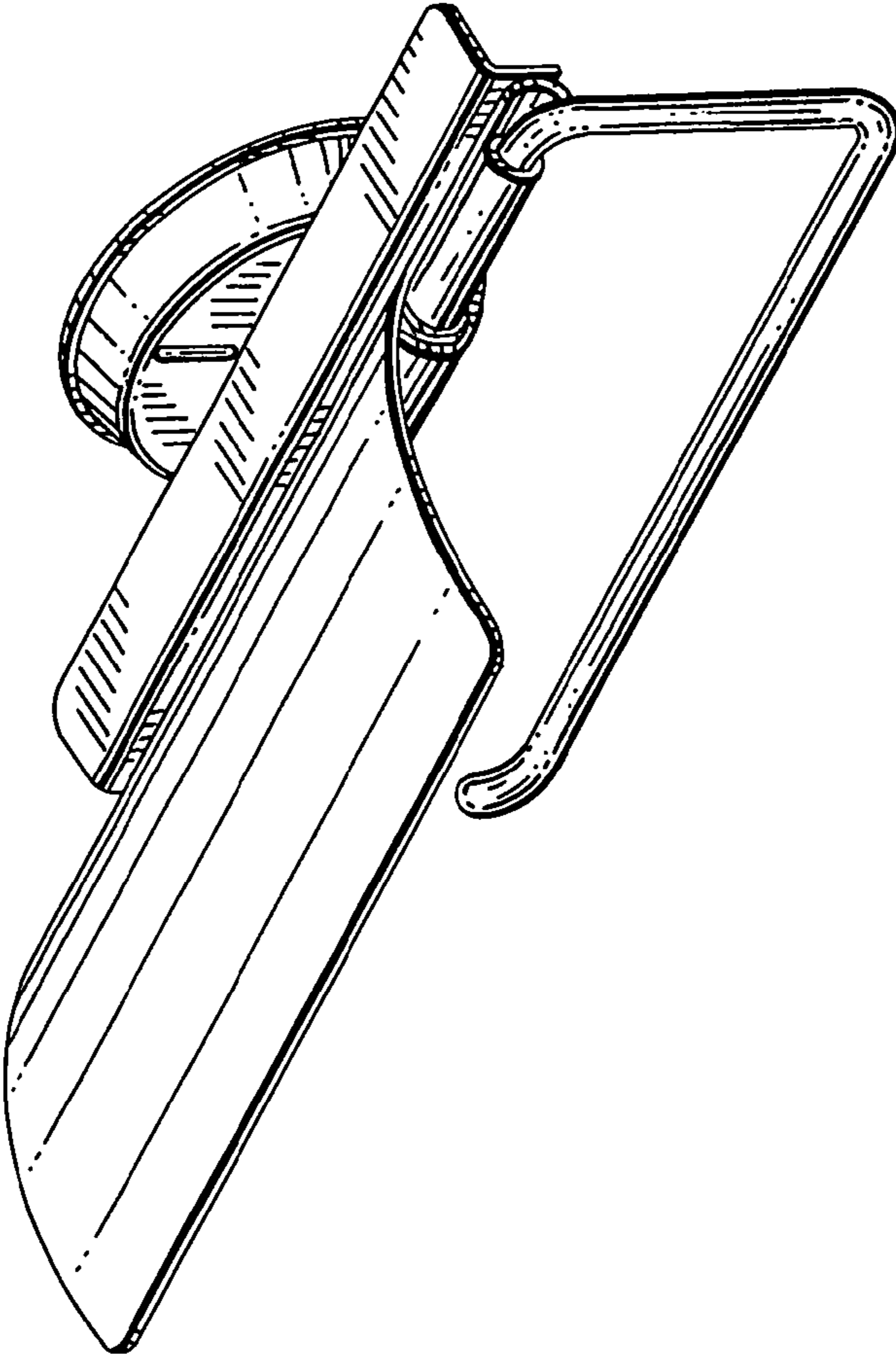

FIG. 8

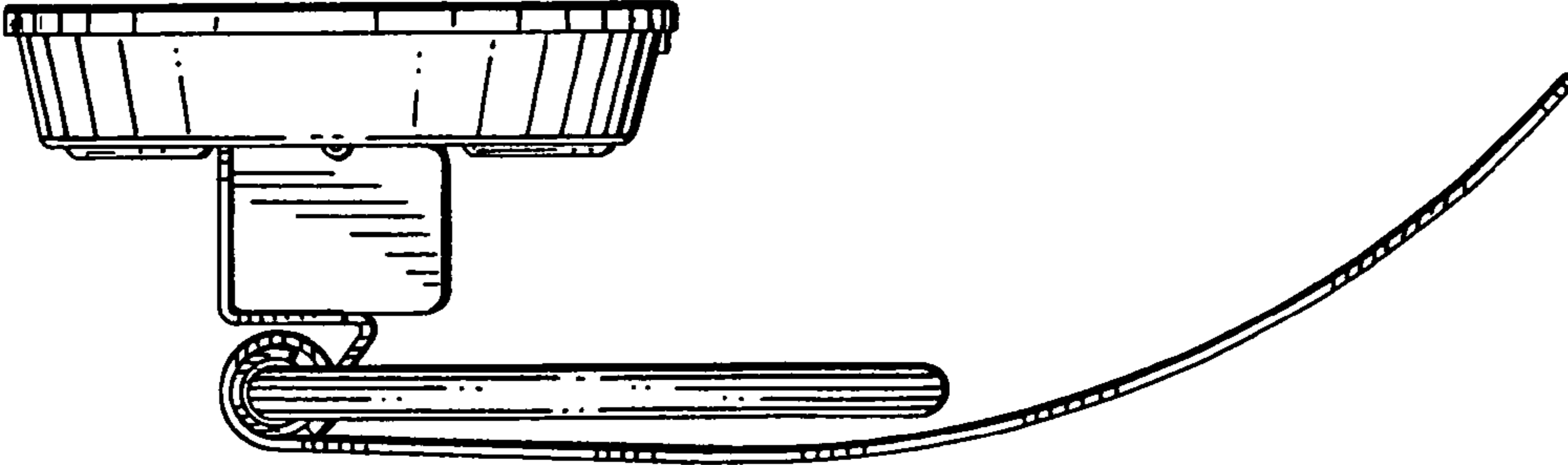
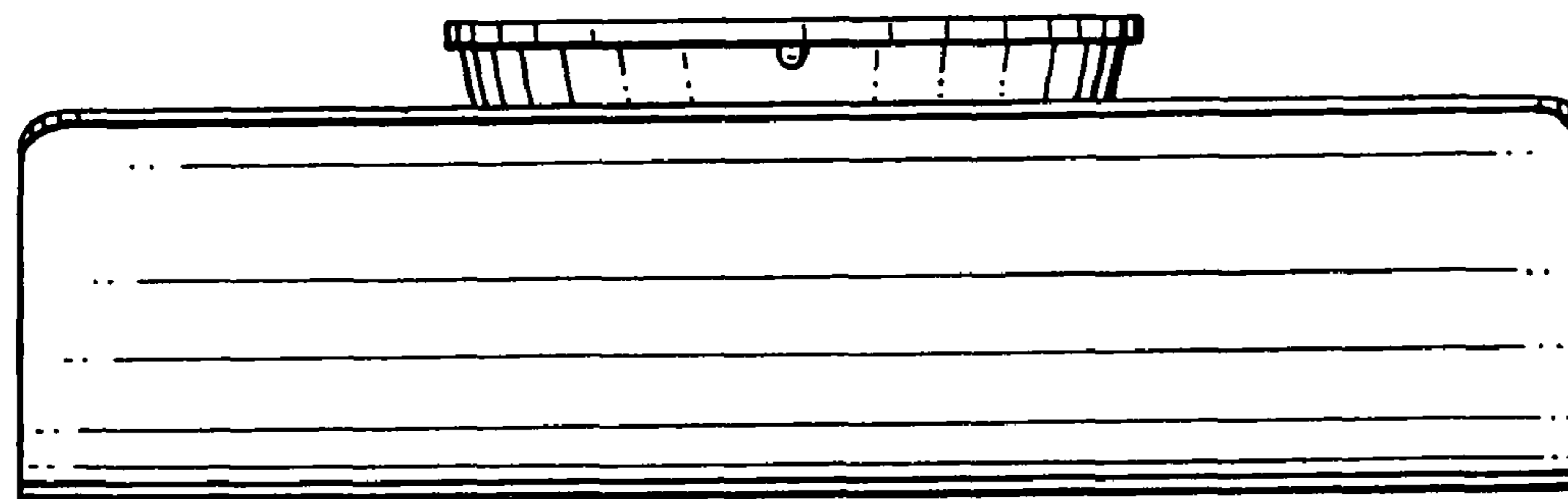
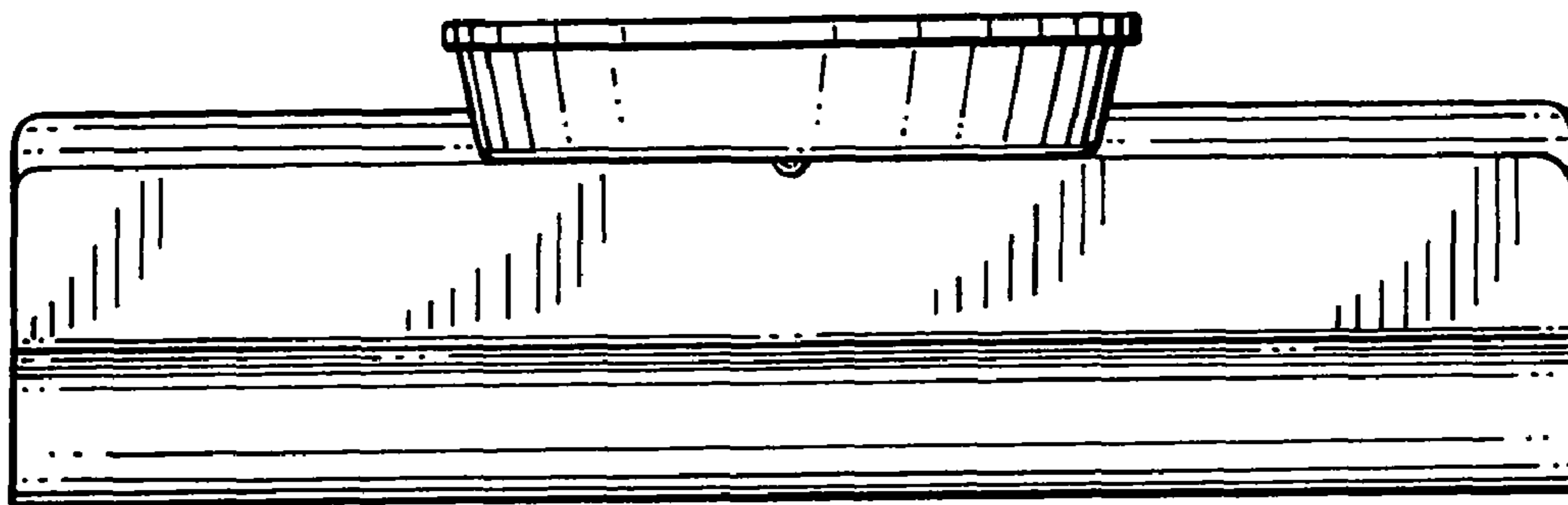

FIG. 5

*FIG. 6*



*FIG. 7*