



US00D621623S

(12) **United States Design Patent**
Chu

(10) **Patent No.:** **US D621,623 S**

(45) **Date of Patent:** **** Aug. 17, 2010**

(54) **DISPLAY**

(75) Inventor: **Chih-Ming Chu**, Taipei (TW)

(73) Assignee: **Hannspree, Inc.**, Taipei (TW)

(**) Term: **14 Years**

(21) Appl. No.: **29/347,443**

(22) Filed: **Jan. 13, 2010**

(51) **LOC (9) Cl.** **06-07**

(52) **U.S. Cl.** **D6/308; D6/310; D14/371**

(58) **Field of Classification Search** **D6/308,**
D6/310, 300, 303-304; D14/371, 125-129;
446/433; D21/631, 539, 324, 325, 329, 332,
D21/512, 515; 40/594; D20/42; D19/59,
D19/60, 62

See application file for complete search history.

(56) **References Cited**

U.S. PATENT DOCUMENTS

1,871,297	A *	8/1932	Berger	446/433
D311,040	S *	10/1990	Kunihiro	D21/631
D425,140	S *	5/2000	Bao	D21/539
D473,865	S *	4/2003	Zuege et al.	D14/371
D474,768	S *	5/2003	Zuege et al.	D14/371

D476,003	S *	6/2003	Zuege et al.	D14/371
D481,721	S *	11/2003	Lin	D14/371
D486,487	S *	2/2004	Zuege et al.	D14/371
D529,009	S *	9/2006	Hoehn	D14/126
D546,298	S *	7/2007	Hoehn	D14/126

* cited by examiner

Primary Examiner—Susan M Lee

Assistant Examiner—Sydney R Buffalow

(74) *Attorney, Agent, or Firm*—Bacon & Thomas, PLLC

(57) **CLAIM**

The ornamental design for a display, as shown.

DESCRIPTION

FIG. 1 is a perspective view of a display showing my new design;

FIG. 2 is a front elevational view thereof;

FIG. 3 is a rear elevational view thereof;

FIG. 4 is a left side elevational view thereof;

FIG. 5 is a right side elevational view thereof;

FIG. 6 is a top plan view thereof; and,

FIG. 7 is a bottom plan view thereof.

1 Claim, 6 Drawing Sheets

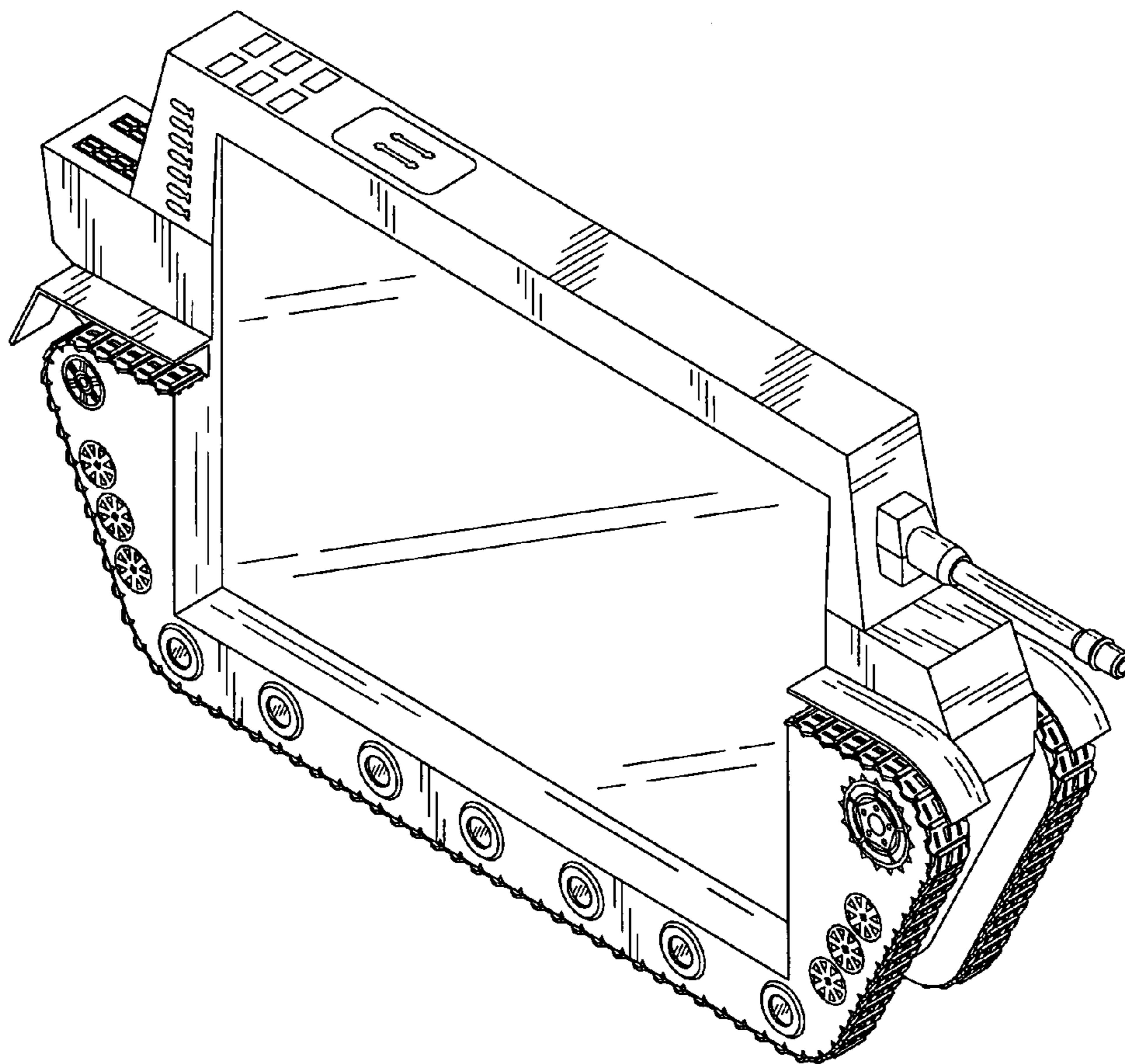

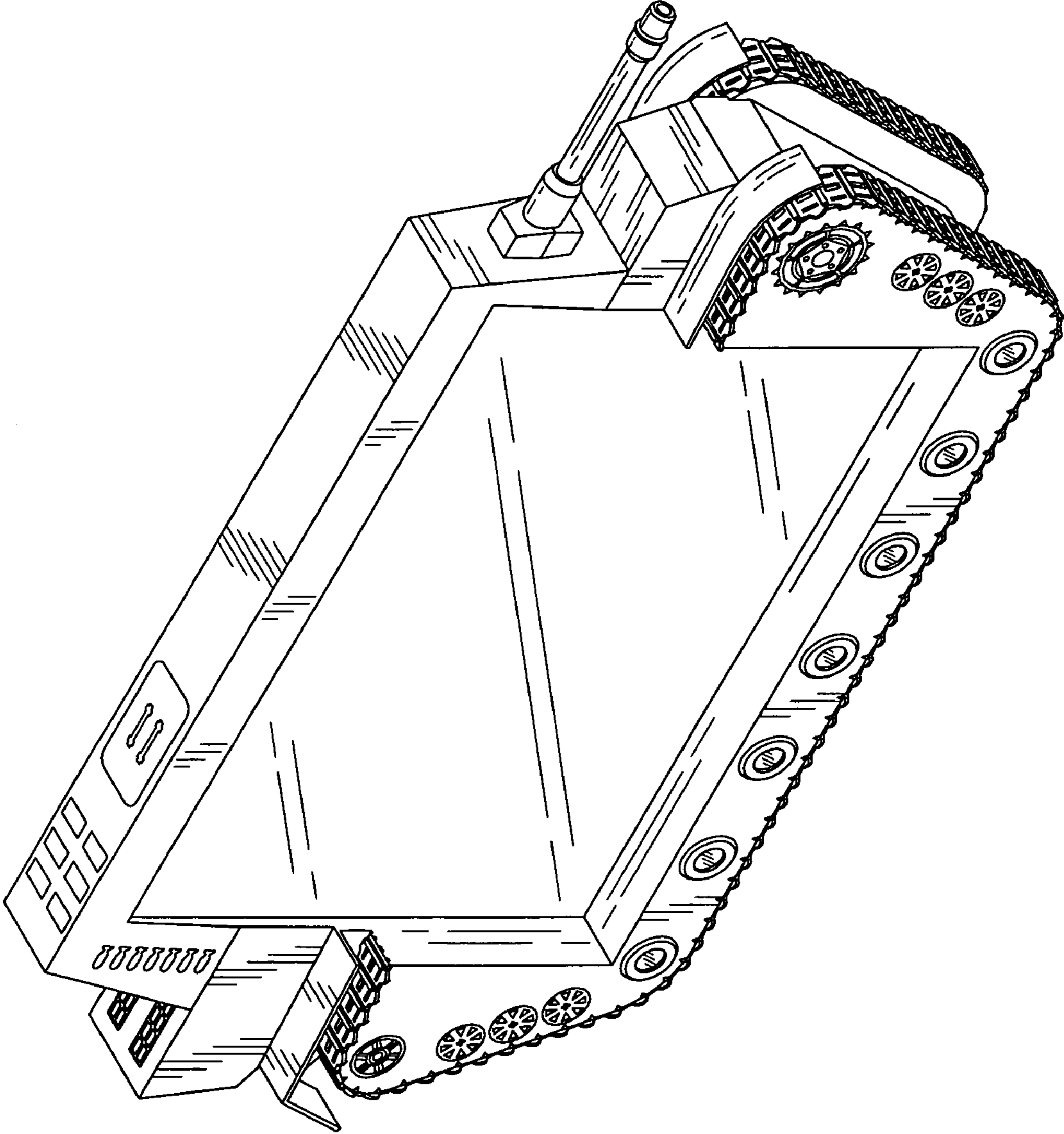

FIG. 1

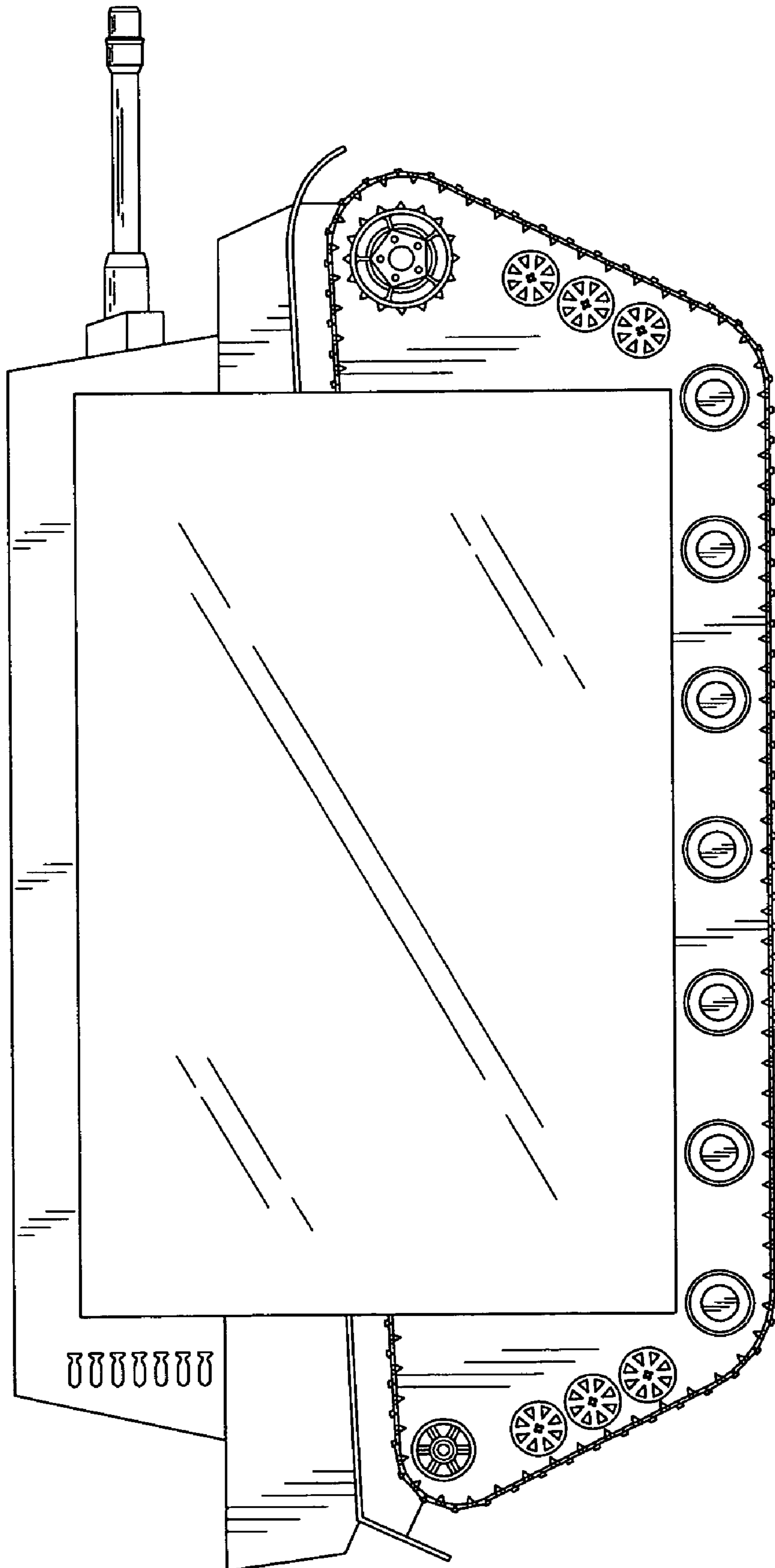

FIG. 2

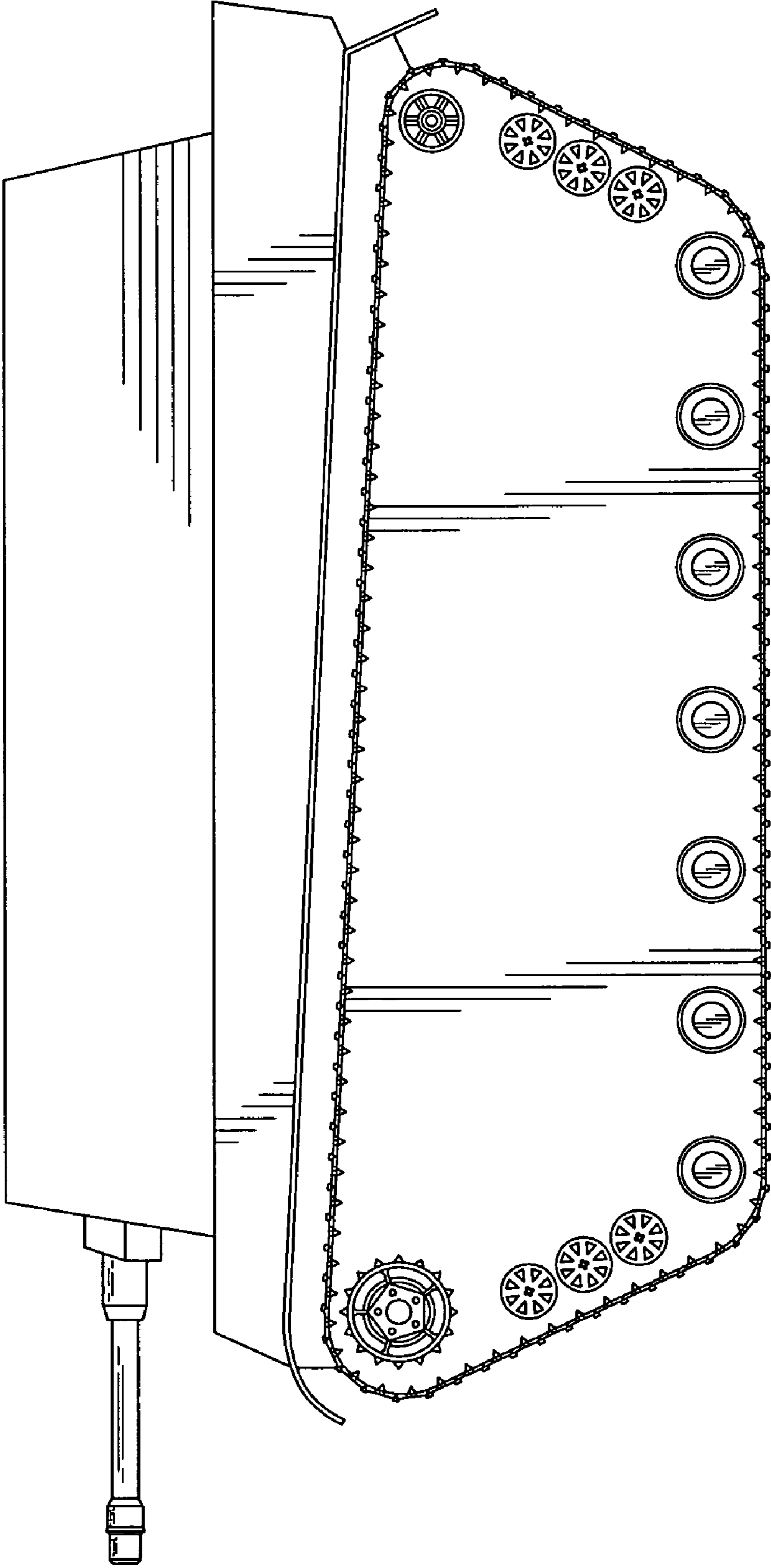

FIG. 3

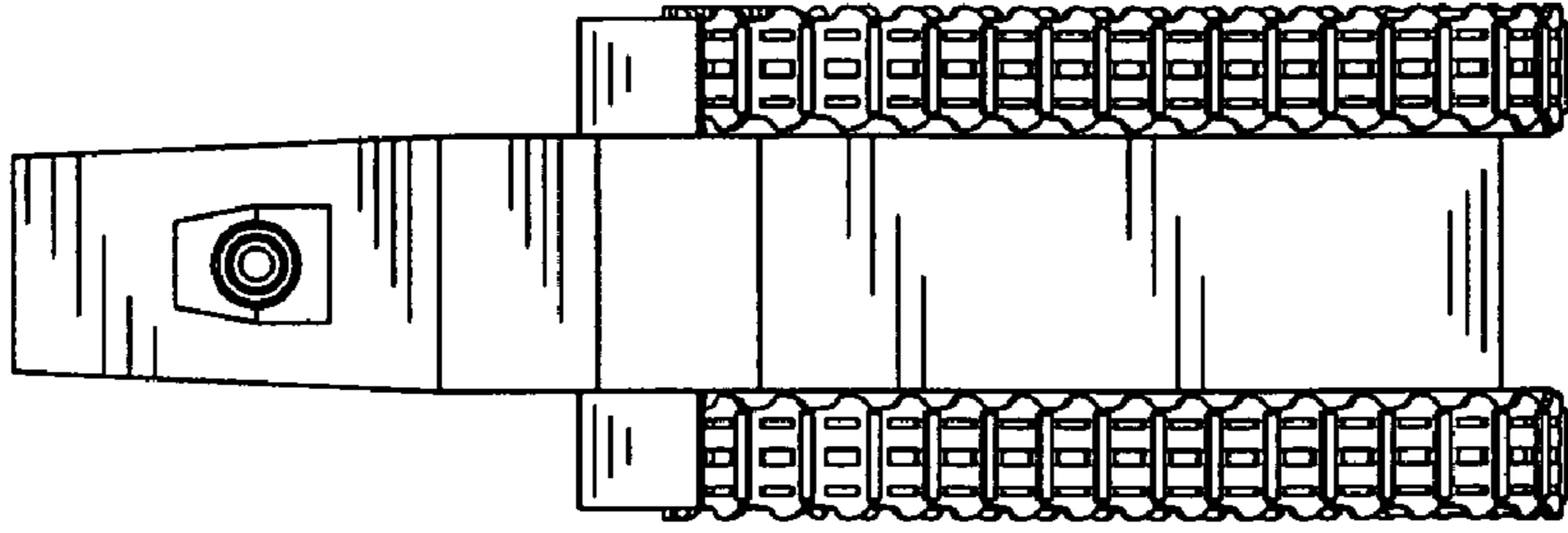

FIG. 5

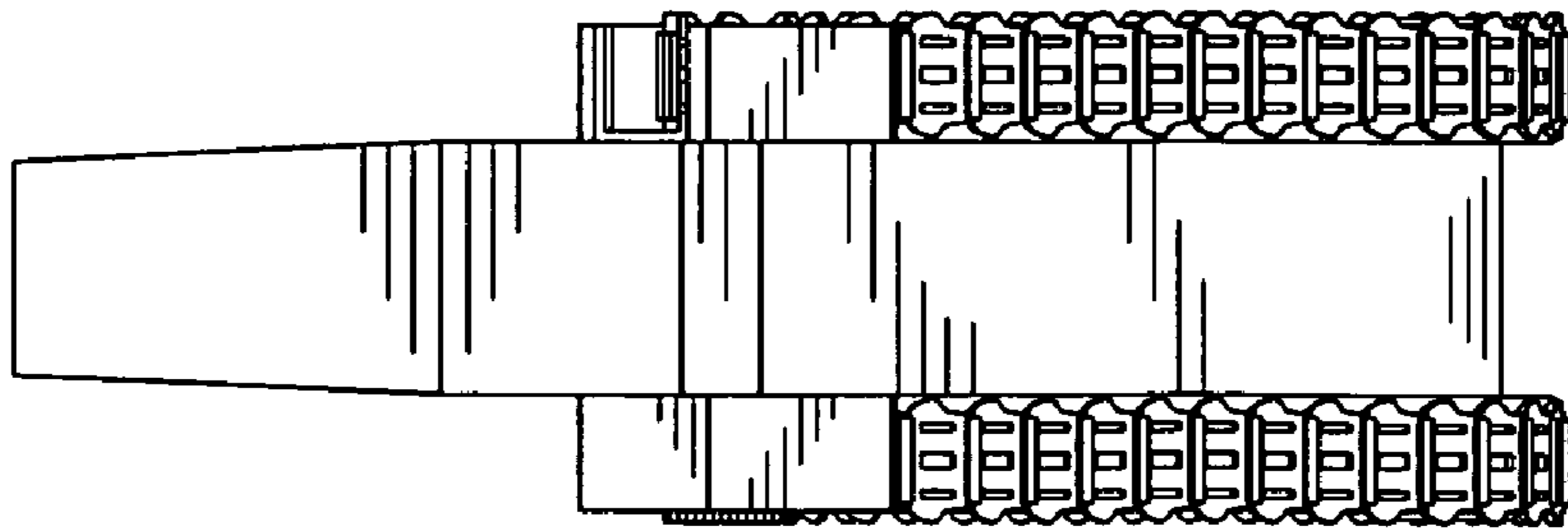

FIG. 4

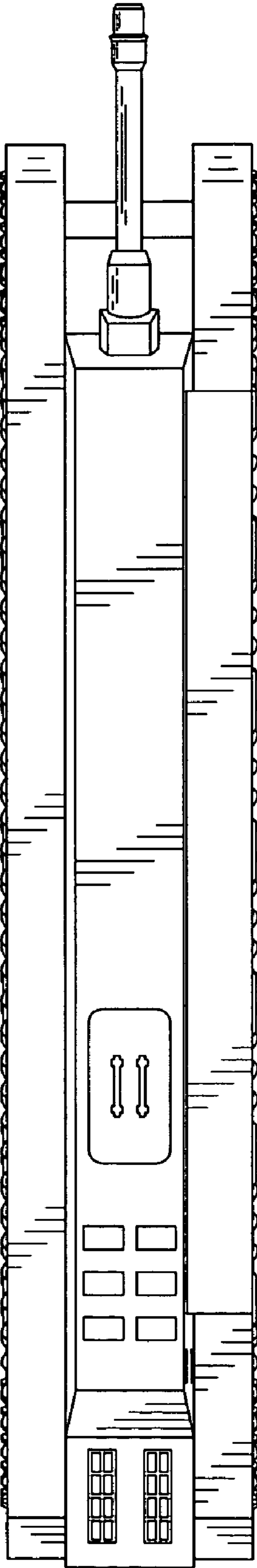

FIG. 6

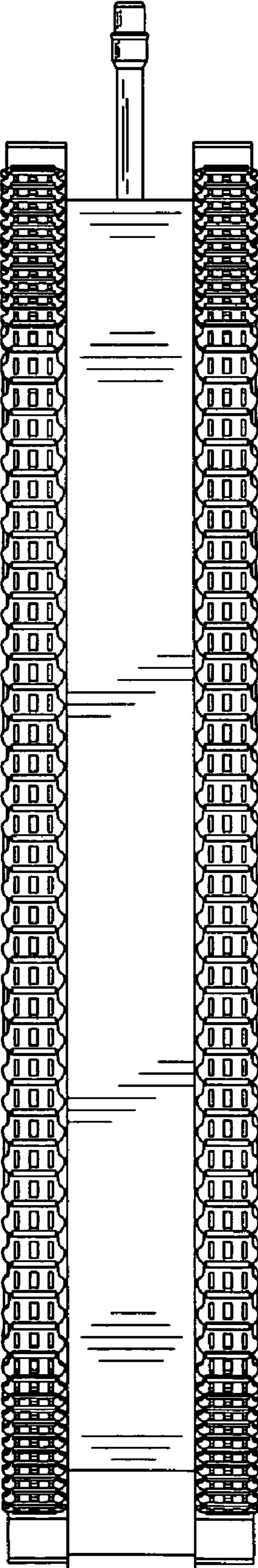

FIG. 7