



US00D621593S

(12) **United States Design Patent**
Martinez

(10) **Patent No.:** **US D621,593 S**

(45) **Date of Patent:** **** Aug. 17, 2010**

(54) **HAT WITH BANDANA**

(76) **Inventor:** **Johnny C. Martinez**, 28041 Tampa Ave., Hayward, CA (US) 94544

(**) **Term:** **14 Years**

(21) **Appl. No.:** **29/343,864**

(22) **Filed:** **Sep. 21, 2009**

Related U.S. Application Data

(63) Continuation-in-part of application No. 29/329,762, filed on Dec. 19, 2008.

(51) **LOC (9) Cl.** **02-03**

(52) **U.S. Cl.** **D2/891**

(58) **Field of Classification Search** D2/500, D2/501, 600, 865, 866, 867, 878, 881, 883, D2/889, 876, 877, 891; 2/9, 10, 171, 172, 2/173, 200.1, 200.2, 200.3, 204, 206, 207, 2/209.13, DIG. 11, 410

See application file for complete search history.

(56) **References Cited**

U.S. PATENT DOCUMENTS

258,446	A *	5/1882	Link	2/108
270,242	A *	1/1883	Mitchell	297/393
350,398	A *	10/1886	Shunk	2/10
D225,695	S *	1/1973	Geiger	D2/862
5,046,195	A *	9/1991	Koritan	2/172
5,605,144	A *	2/1997	Simmons et al.	126/204
D381,191	S *	7/1997	Monkhouse et al.	D2/891
D392,090	S *	3/1998	Monkhouse et al.	D2/891
D420,493	S *	2/2000	Blake	D2/866

6,247,180	B1 *	6/2001	Heinz	2/171
6,247,181	B1 *	6/2001	Hirsch et al.	2/207
D458,004	S *	6/2002	Magdziak-Hautala	D2/500
7,082,619	B1 *	8/2006	Thompson	2/175.5
7,350,241	B2 *	4/2008	Gendall	2/206
D598,052	S *	8/2009	Esfahani et al.	D19/81
2005/0034215	A1 *	2/2005	Harrison et al.	2/207

OTHER PUBLICATIONS

Emblem of skull with bandana, as shown on www.flickr.com, downloaded May 3, 2008 (4 pages).*

* cited by examiner

Primary Examiner—Elizabeth A Albert

Assistant Examiner—Karen E Eldridge Powers

(74) *Attorney, Agent, or Firm*—GSS Law Group

(57) **CLAIM**

The ornamental design for a hat with bandana, as shown and described.

DESCRIPTION

FIG. 1 is a rear perspective view of the hat with bandana;

FIG. 2 is a back elevation view of the hat with bandana;

FIG. 3 is a front elevation view of the hat with bandana;

FIG. 4 is a side elevation view of the hat with bandana; the opposite side is a mirror image of the hat with bandana shown in FIG. 4;

FIG. 5 is a top plan view of the hat with bandana; and,

FIG. 6 is a bottom plan view of the hat with bandana.

The broken lines shown in the drawings illustrate environmental matter and form no part of the claimed design.

1 Claim, 6 Drawing Sheets

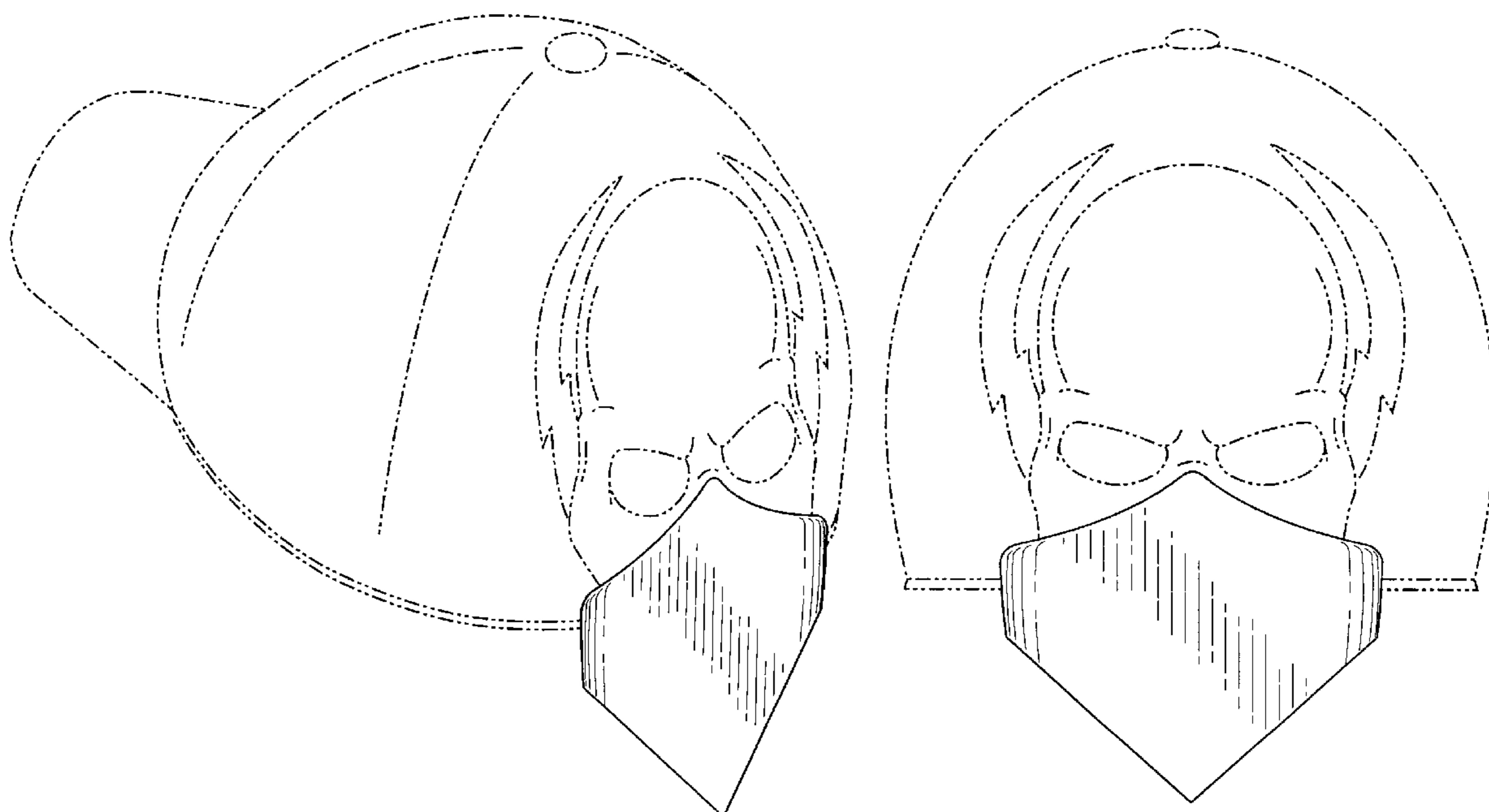

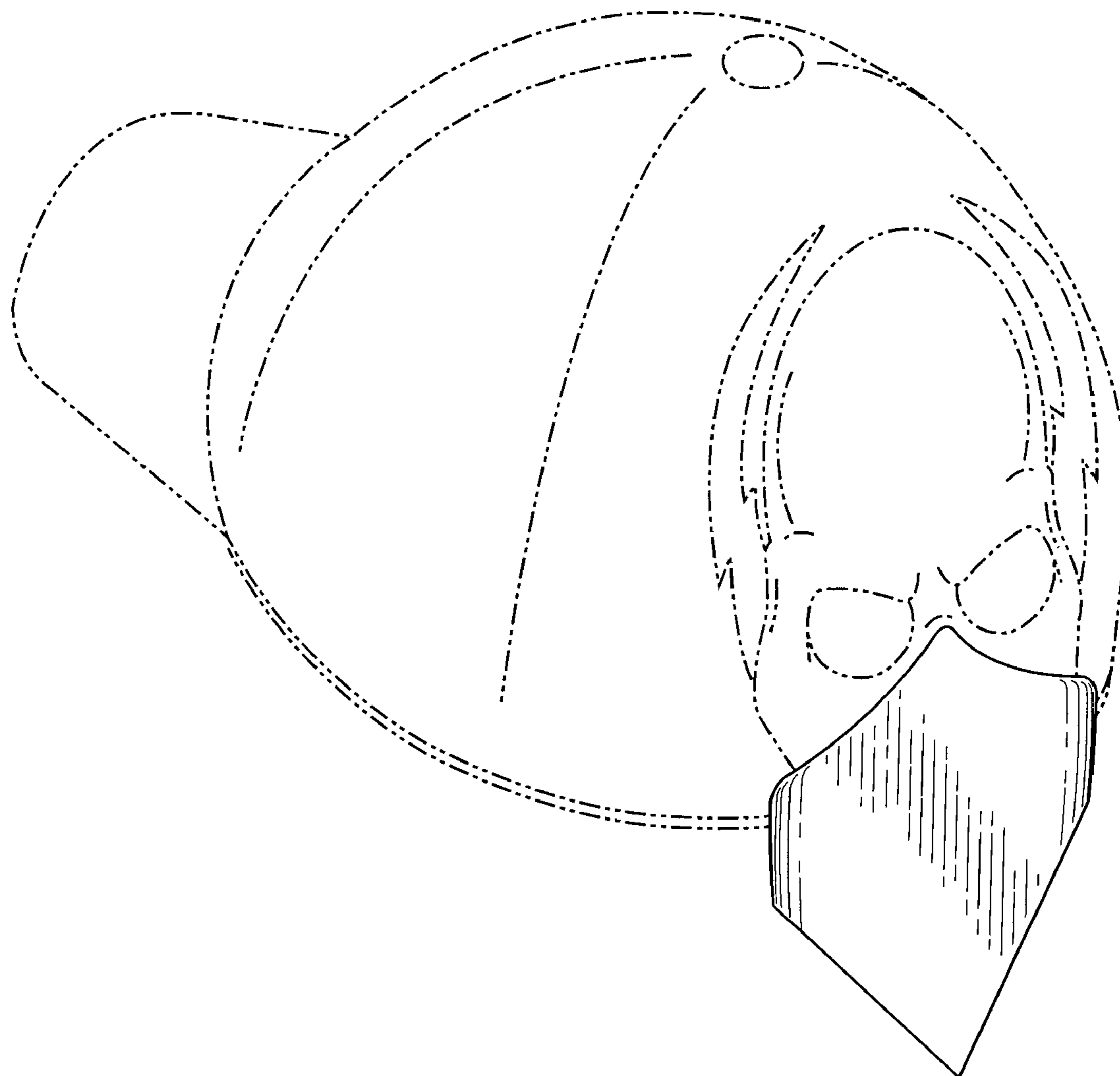

FIG. 1

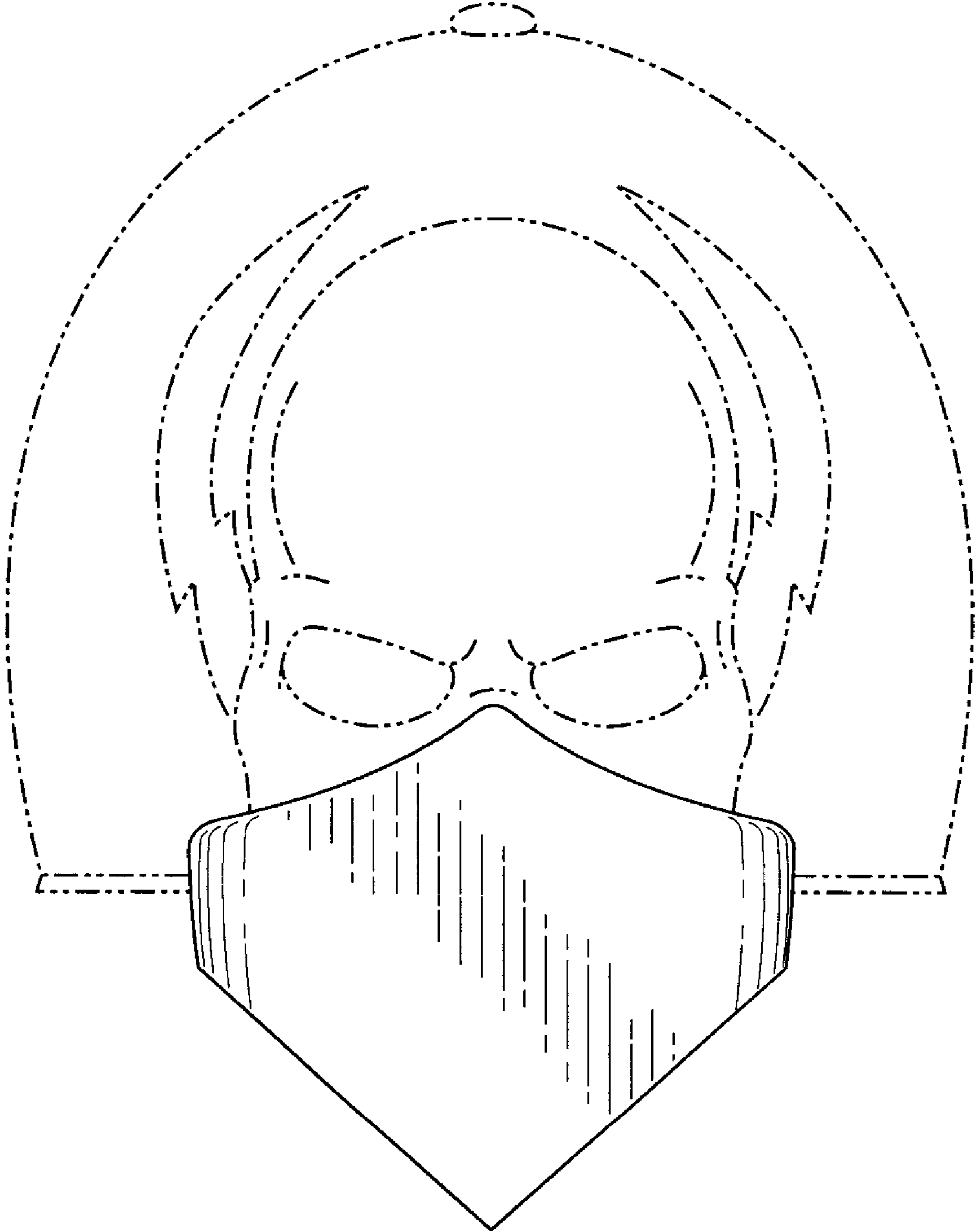

FIG. 2

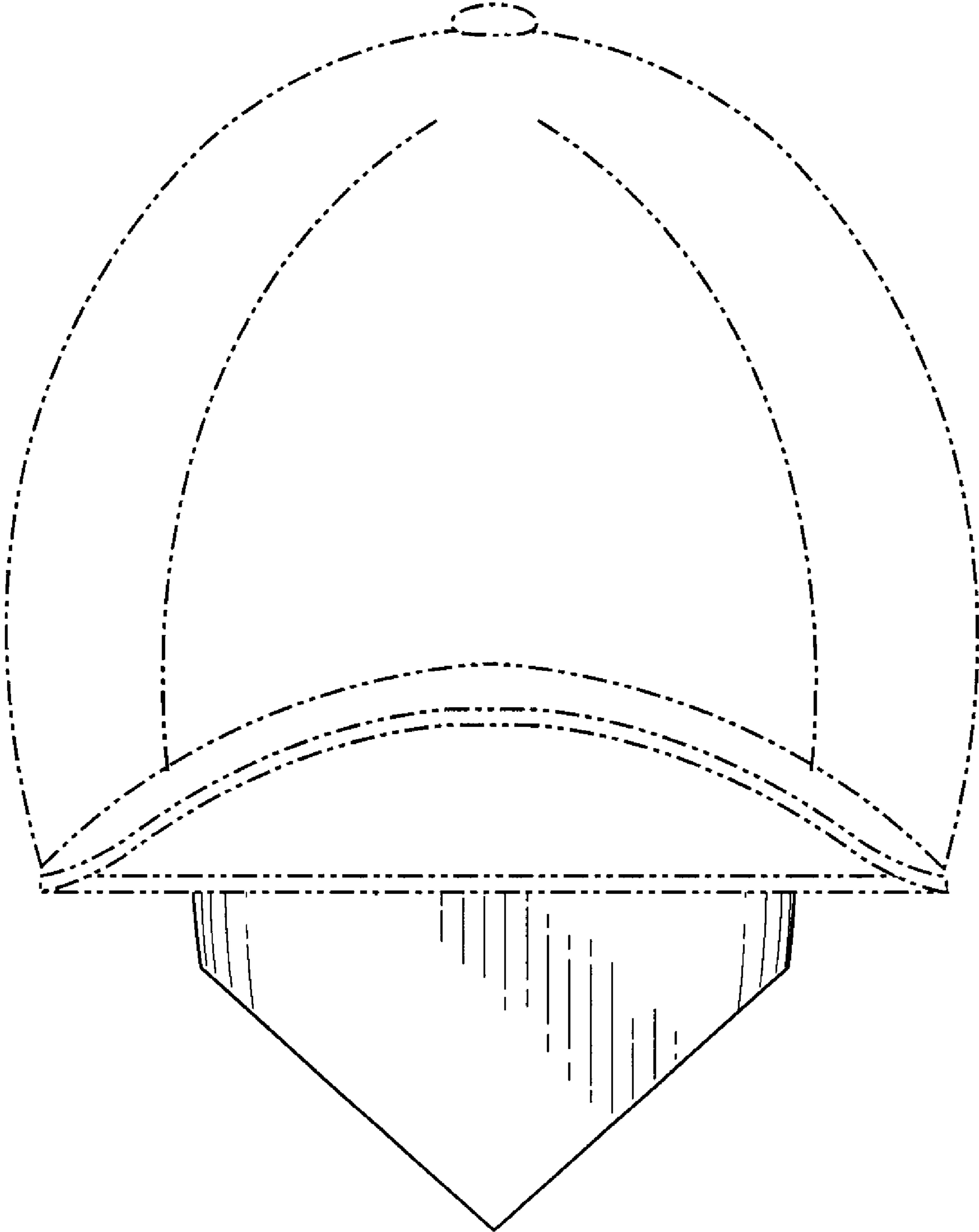

FIG. 3

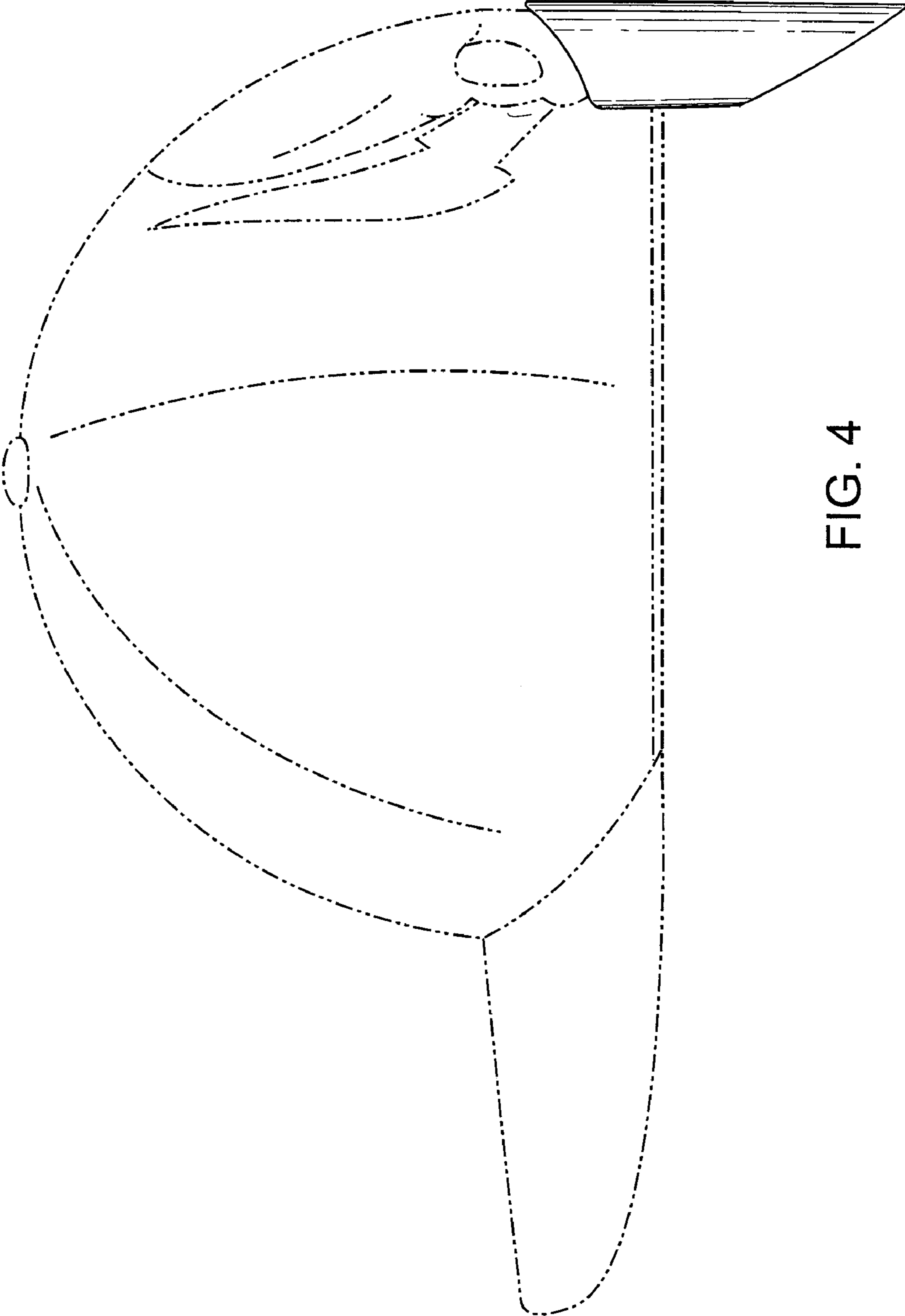

FIG. 4

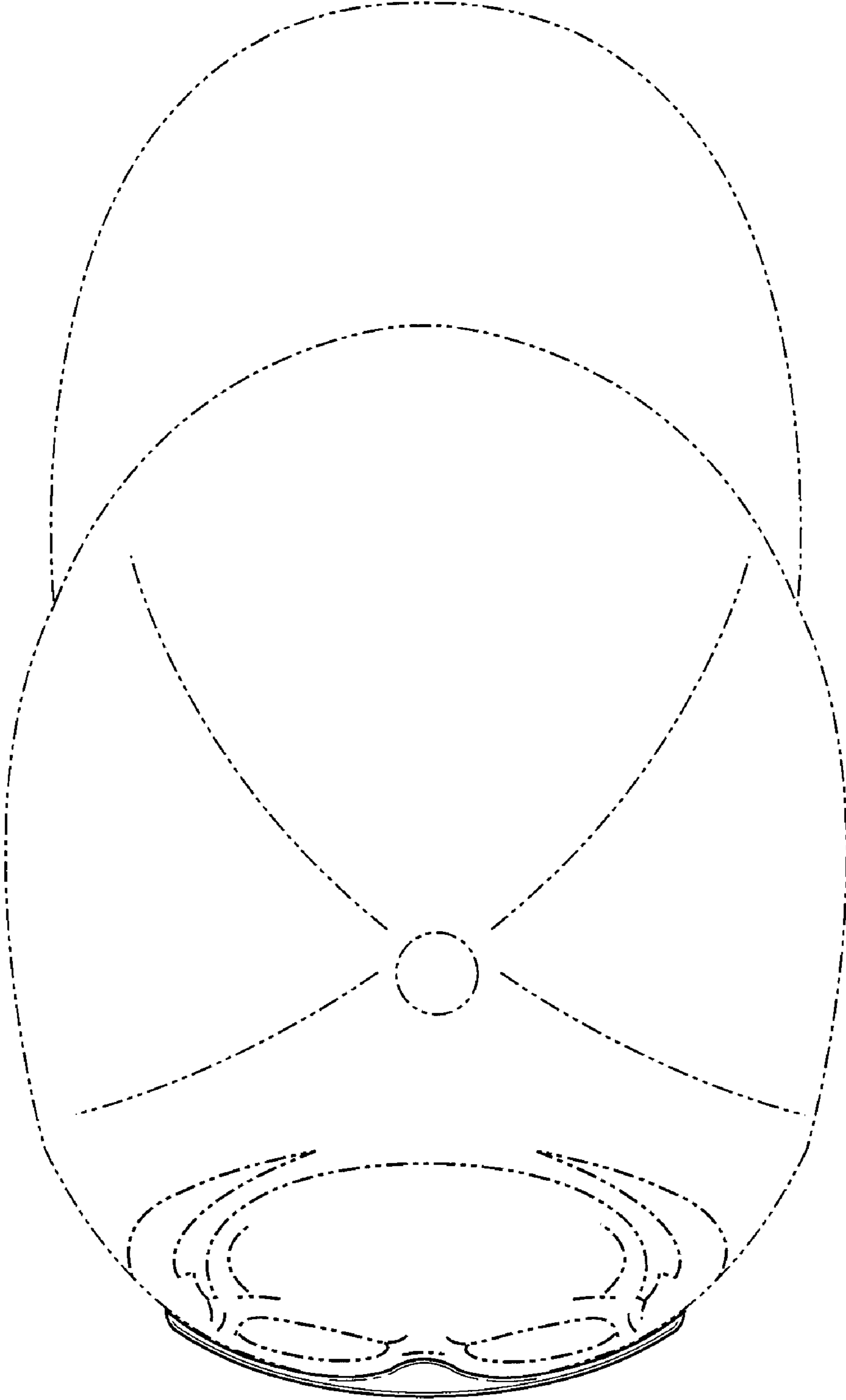

FIG. 5

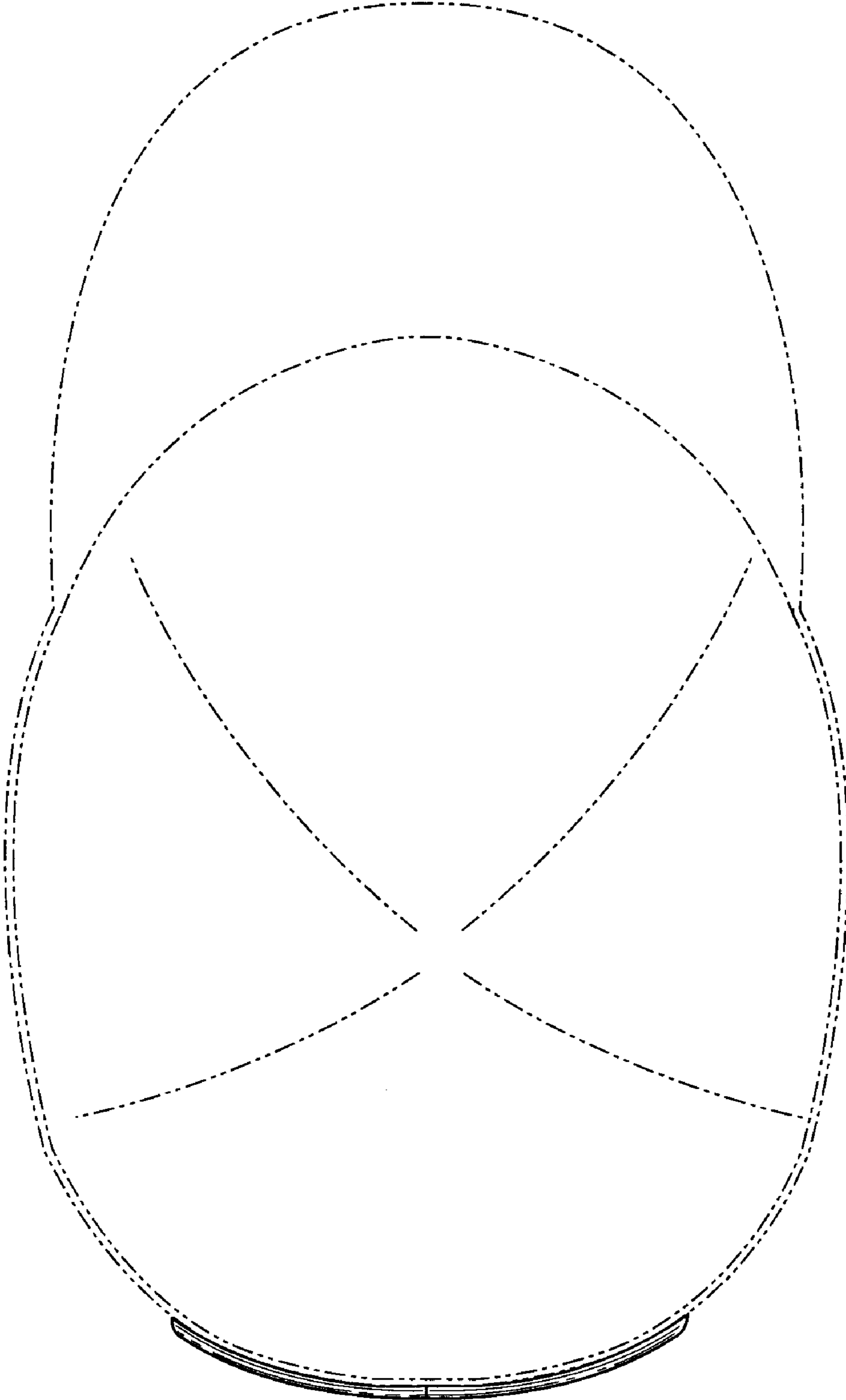

FIG. 6