



US00D621545S

(12) **United States Design Patent**
Nishizawa

(10) **Patent No.:** **US D621,545 S**

(45) **Date of Patent:** **** Aug. 10, 2010**

(54) **ELECTRIC SHAVER**

FOREIGN PATENT DOCUMENTS

(75) Inventor: **Tsuyoshi Nishizawa**, Milan (IT)

JP 2008-142275 A 6/2008

* cited by examiner

(73) Assignee: **Panasonic Electric Works Co., Ltd.**,
Kadoma-shi (JP)

Primary Examiner—Jennifer Rivard

(74) *Attorney, Agent, or Firm*—Marvin A. Motsenbocker;
Mots Law, PLLC

(**) Term: **14 Years**

(21) Appl. No.: **29/351,683**

(57) **CLAIM**

(22) Filed: **Dec. 9, 2009**

The ornamental design for an electric shaver, as shown and described.

(30) **Foreign Application Priority Data**

DESCRIPTION

Jun. 10, 2009 (JP) 2009-013168

FIG. 1 is a perspective view of an electric shaver;

(51) **LOC (9) Cl.** **28-03**

FIG. 2 is a front view thereof;

(52) **U.S. Cl.** **D28/51**

FIG. 3 is a right side view thereof;

(58) **Field of Classification Search** 30/29.5,
30/30, 32, 34.05, 34.1, 34.2, 43–43.92, 44–45,
30/526–537, 196, 201, 223, 233, 233.5; D28/44,
D28/44.1, 49–54

FIG. 4 is a rear view thereof;

FIG. 5 is a 5—5 right side cross-sectional view thereof with-
out internal structure;

See application file for complete search history.

FIG. 6 is a 6—6 end view of a sectioned part thereof without
internal structure;

(56) **References Cited**

FIG. 7 is a 7—7 end view of a sectioned part thereof without
internal structure;

U.S. PATENT DOCUMENTS

FIG. 8 is an 8a—8a partial end view of a sectioned part
thereof along 8b—8b line without internal structure;

D512,183 S * 11/2005 Nagano et al. D28/51

FIG. 9 is a top plan view thereof; and,

D514,254 S * 1/2006 Nishizawa D28/49

FIG. 10 is a bottom plan view thereof.

D523,586 S * 6/2006 Nishizawa D28/51

D549,874 S * 8/2007 Nishizawa D28/51

D549,875 S * 8/2007 Akahori et al. D28/51

D571,956 S * 6/2008 Nishizawa D28/49

D571,957 S * 6/2008 Nishizawa D28/51

D572,408 S * 7/2008 Nishizawa D28/49

D610,309 S * 2/2010 Nishizawa D28/54

2006/0265879 A1 * 11/2006 Sagawa et al. 30/43.9

Broken lines and hatchings shown in drawings are for illus-
trative purposes only and form no part of the claimed design.

1 Claim, 10 Drawing Sheets

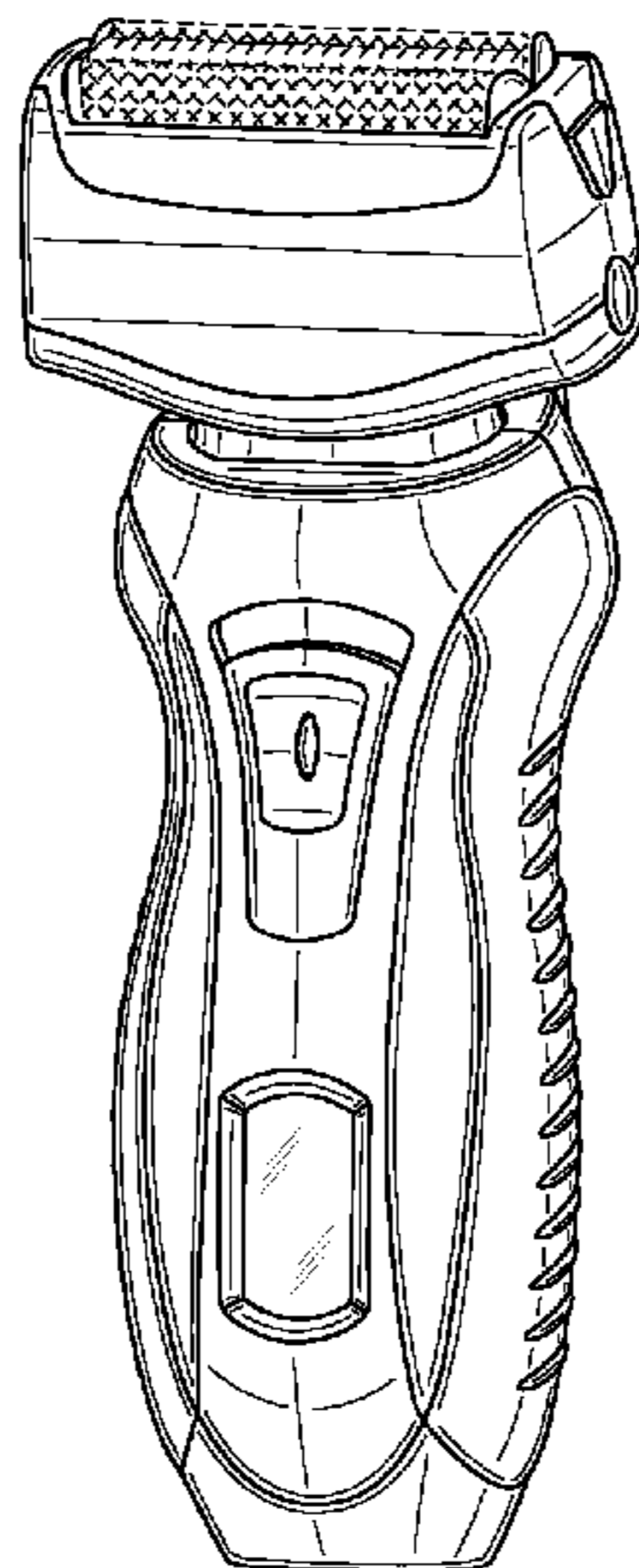

Fig. 1

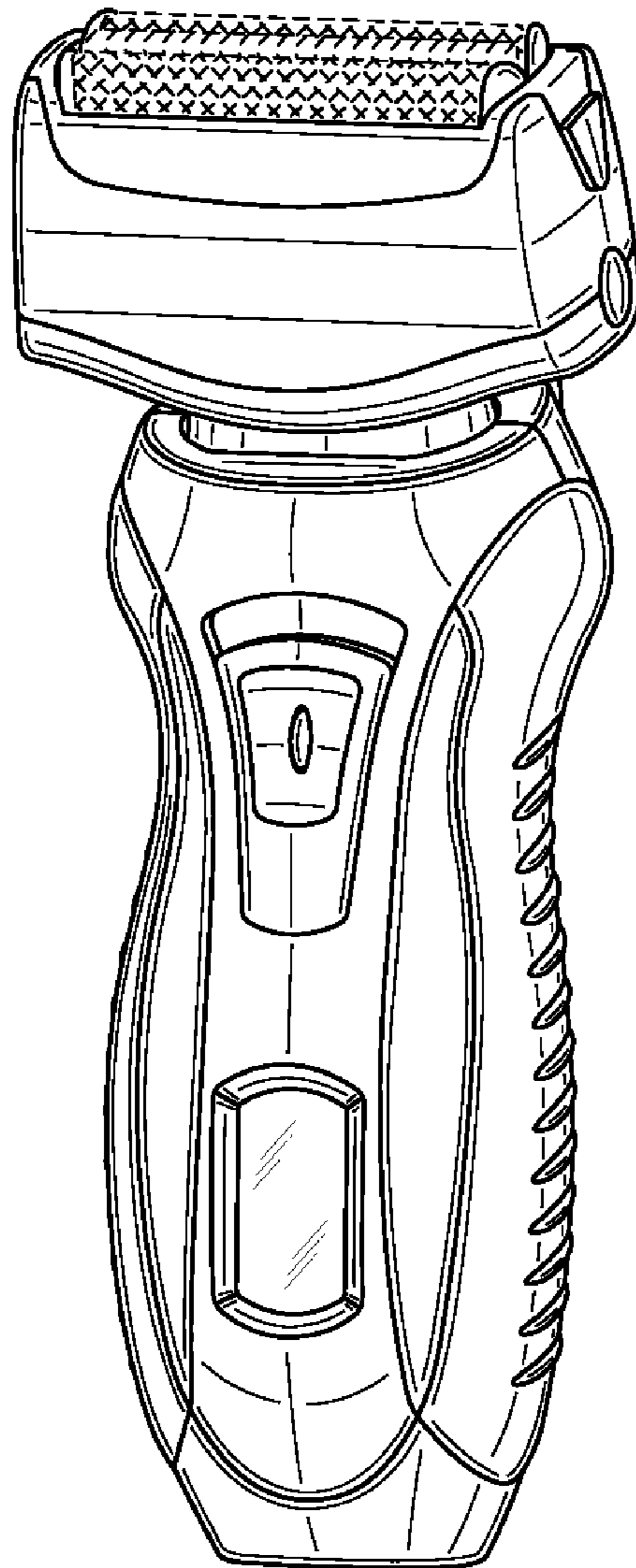

Fig. 2

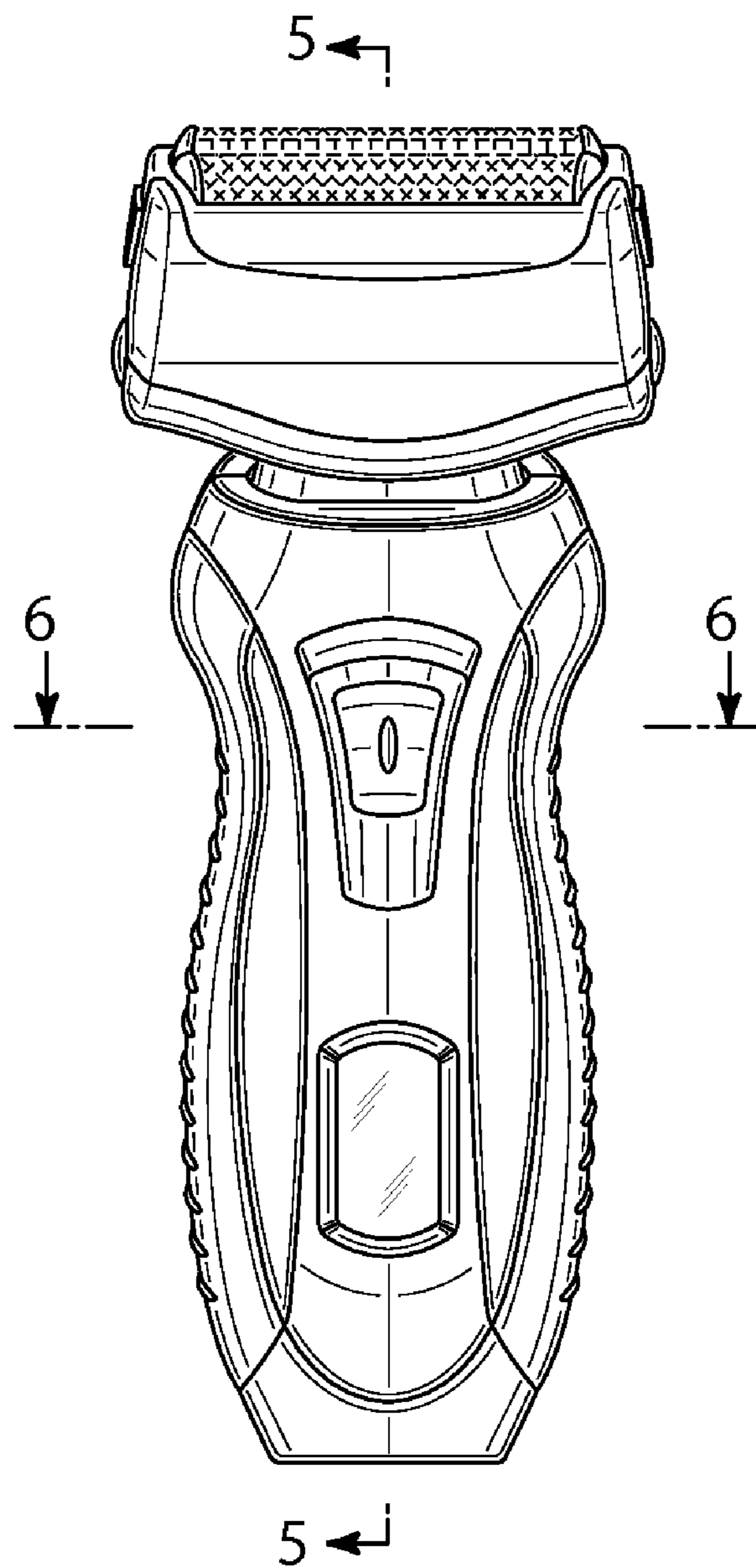

Fig. 3

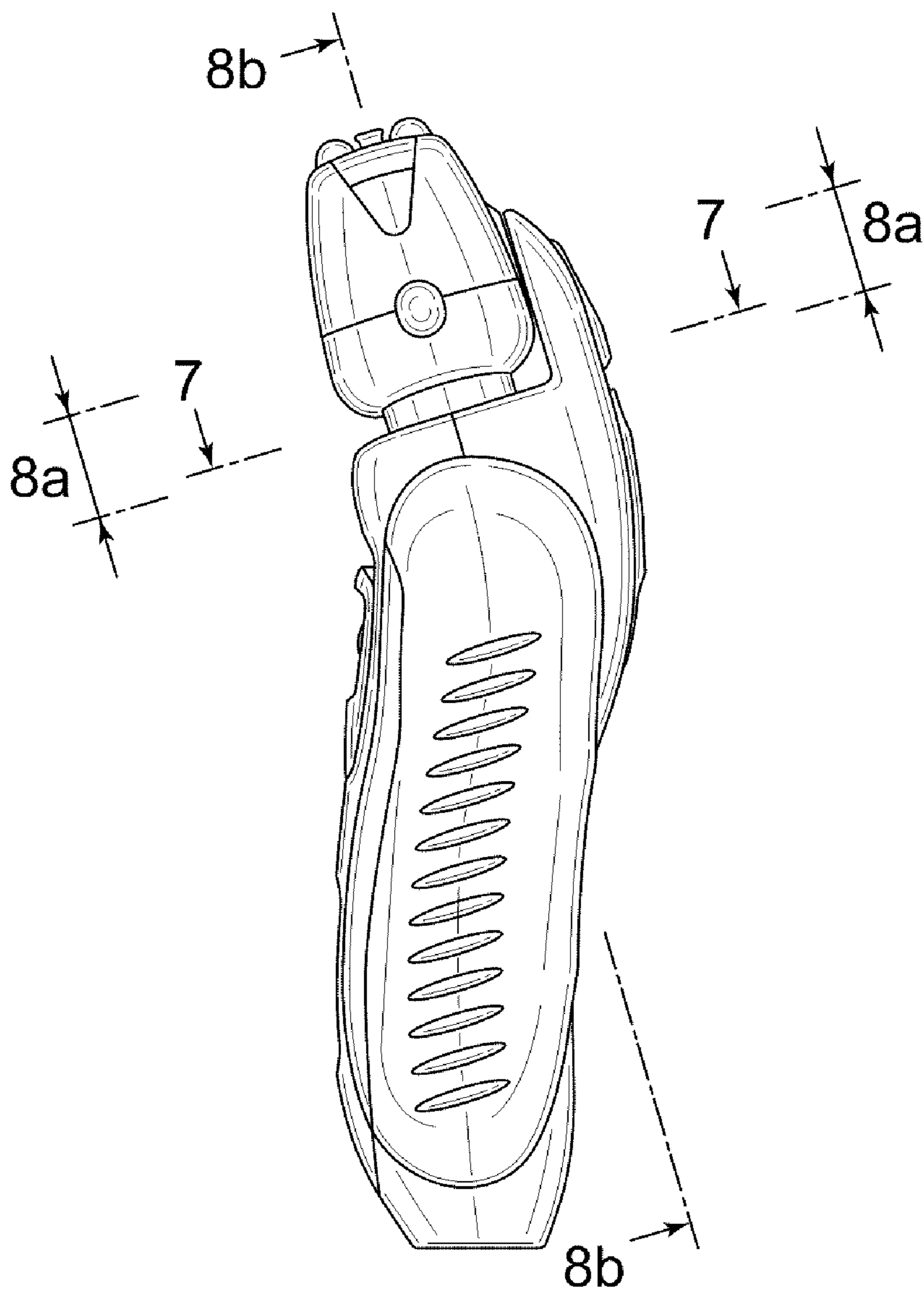

Fig. 4

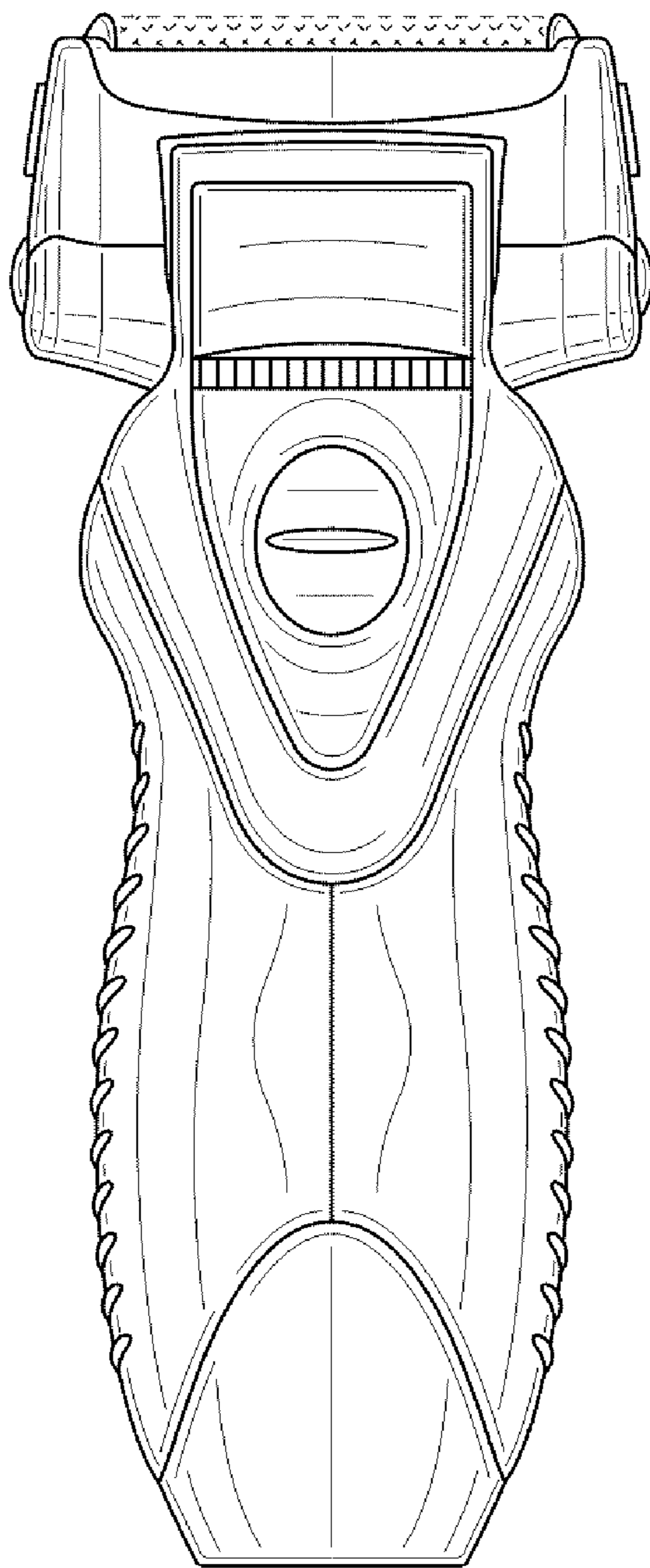

Fig. 5

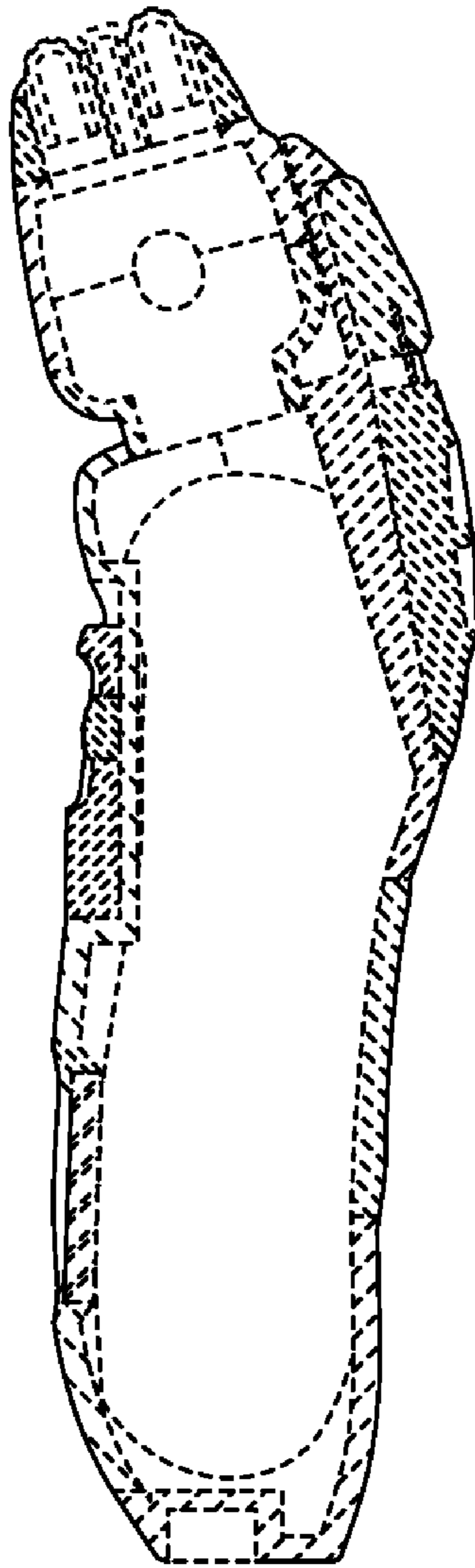

Fig. 6

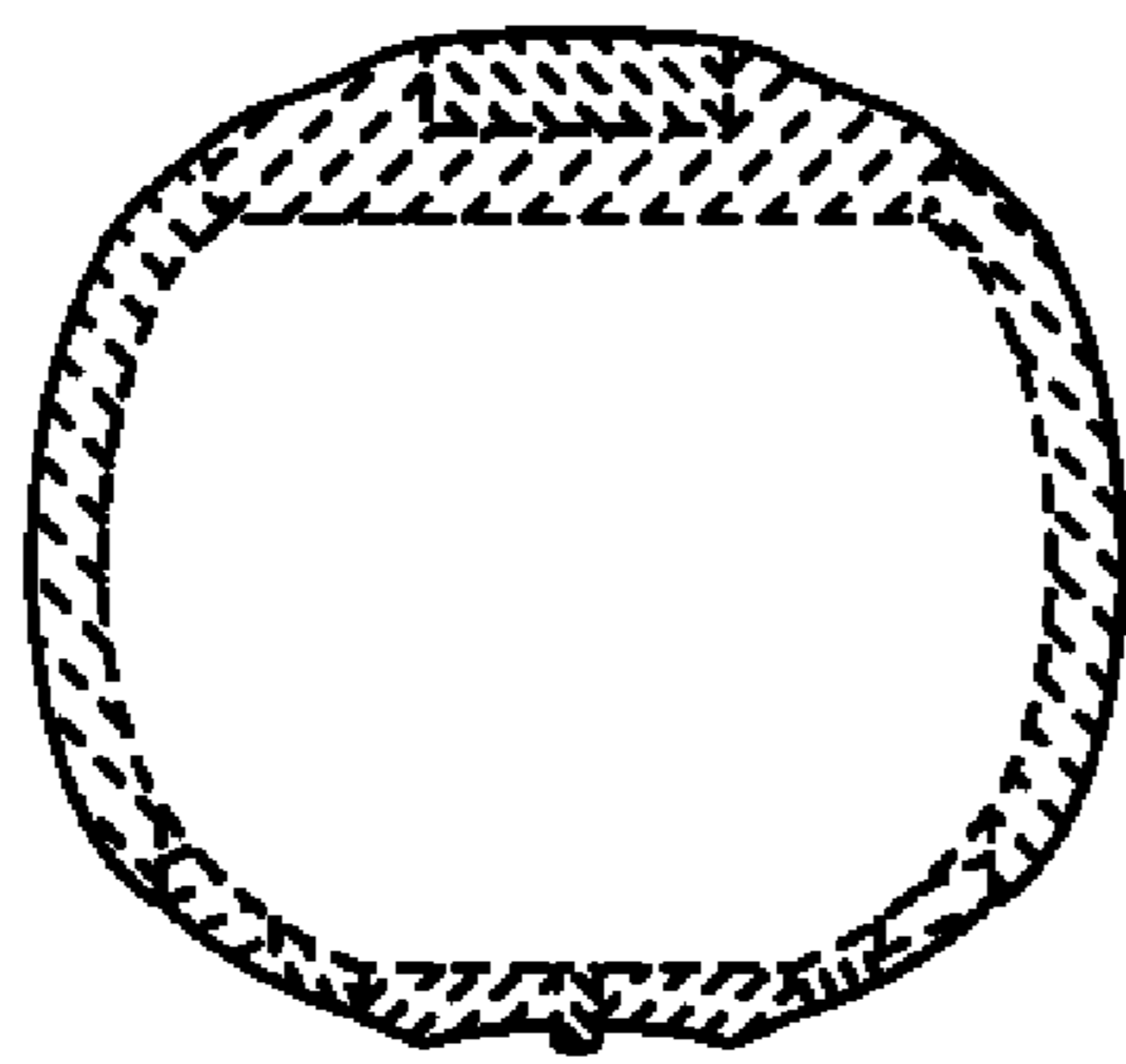

Fig. 7

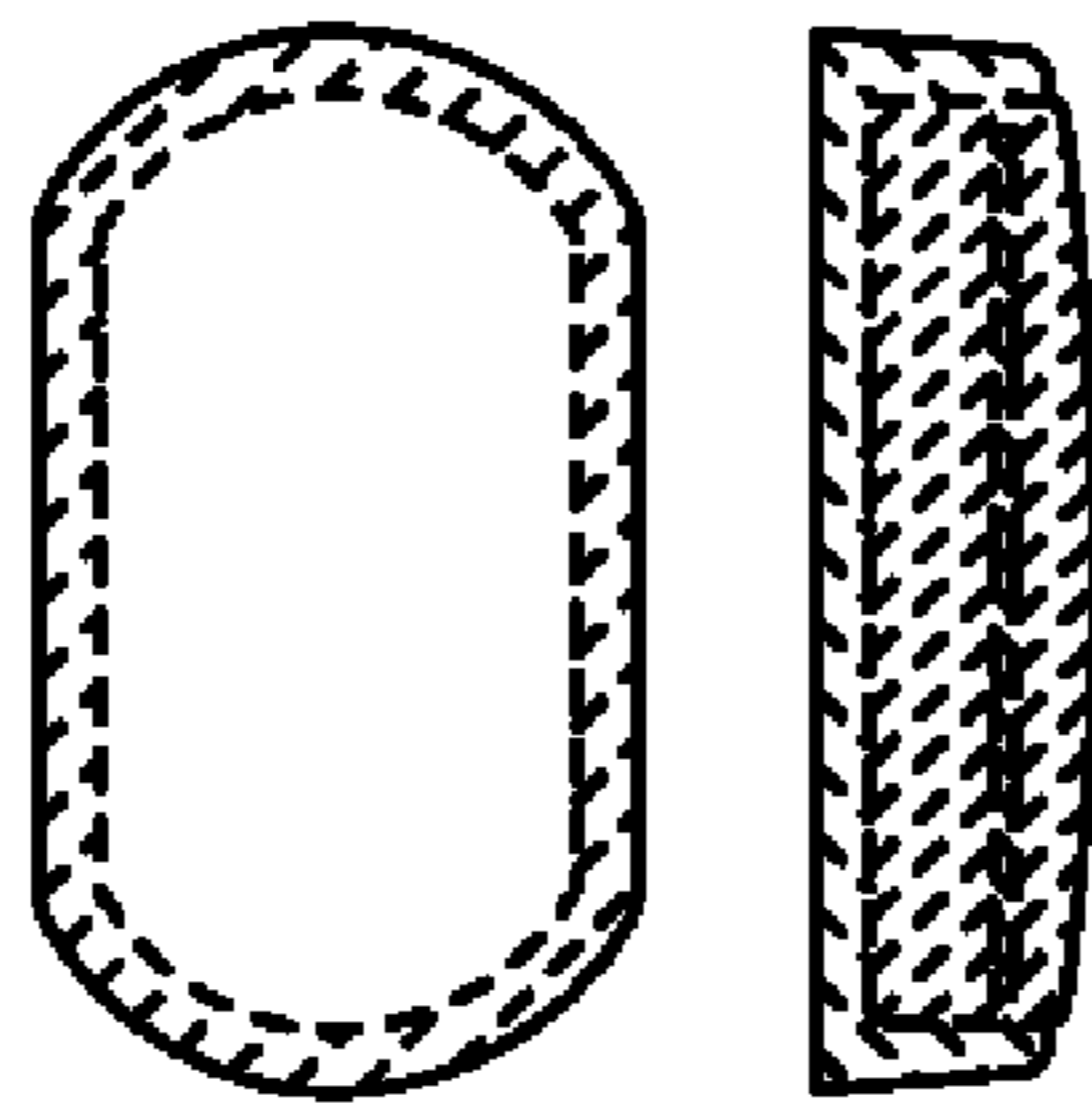

Fig. 8



Fig. 9

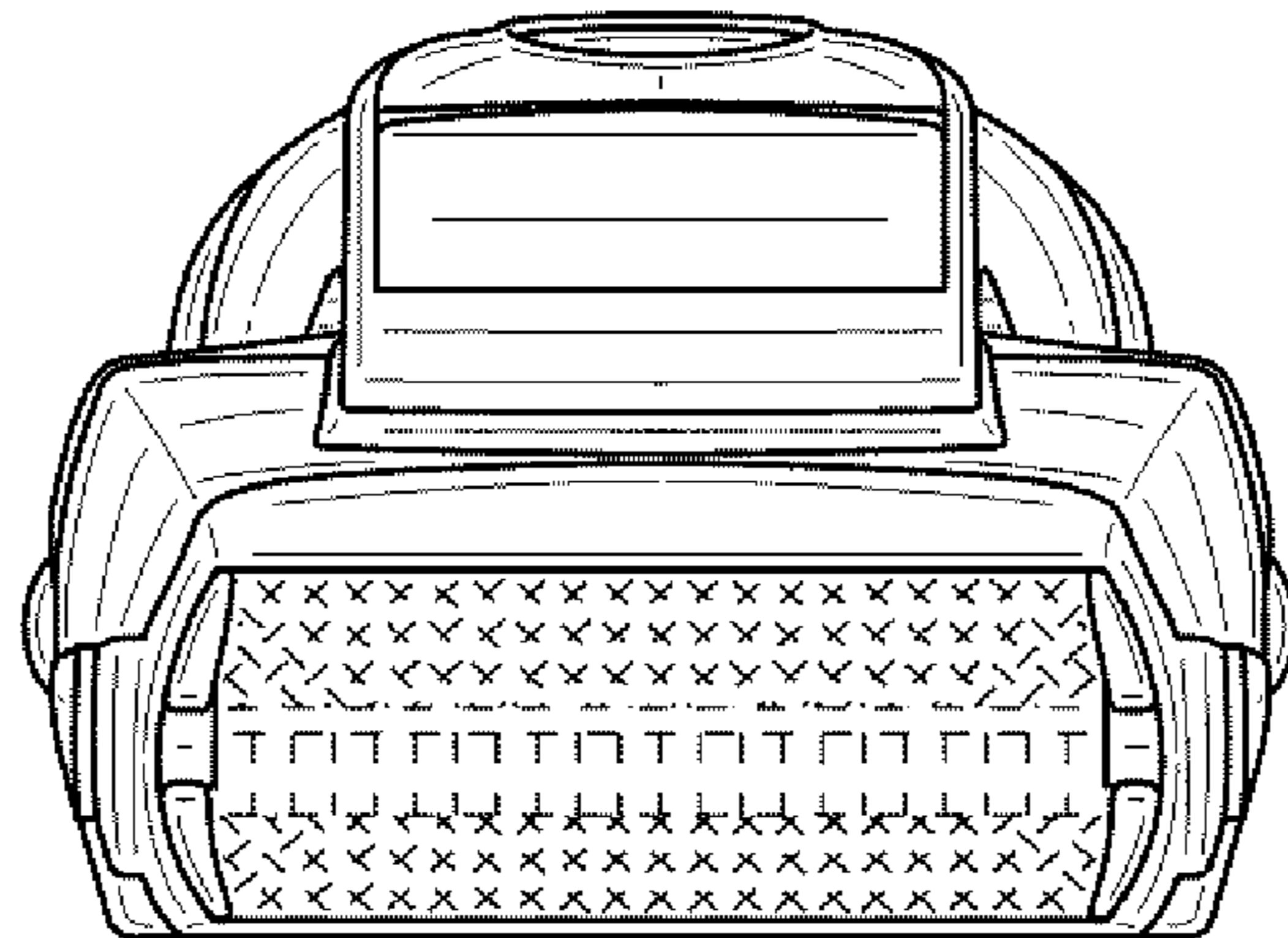

Fig. 10

