



US00D621313S

(12) **United States Design Patent**
Kimura et al.

(10) **Patent No.:** **US D621,313 S**
(45) **Date of Patent:** **** Aug. 10, 2010**

(54) **DOOR MIRROR FOR MOTOR VEHICLE**

2008/0310041 A1* 12/2008 Sinelli et al. 359/879

(75) Inventors: **Dai Kimura**, Hiroshima (JP); **Hitomaro Asano**, Hiroshima (JP); **Shun Yamashita**, Hiroshima (JP)

FOREIGN PATENT DOCUMENTS

JP	D1174116	5/2003
JP	D1177405	6/2003
JP	D1257776	12/2005
JP	D1345525	12/2008
JP	D1347790	1/2009

(73) Assignee: **Mazda Motor Corporation** (JP)

(**) Term: **14 Years**

* cited by examiner

(21) Appl. No.: **29/344,985**

Primary Examiner—Caron Veynar

Assistant Examiner—Katrina A Kile

(22) Filed: **Oct. 7, 2009**

(74) *Attorney, Agent, or Firm*—Studebaker & Brackett PC;
Donald R. Studebaker

(30) **Foreign Application Priority Data**

Apr. 7, 2009 (CN) 2009 3 0009726

(57) **CLAIM**

(51) **LOC (9) Cl.** **12-16**

The ornamental design for a door mirror for motor vehicle, as shown and described.

(52) **U.S. Cl.** **D12/187**

(58) **Field of Classification Search** D12/187,
D12/188–189, 96; D6/300, 309; 359/838,
359/841, 843, 844, 868, 871, 604, 881, 514,
359/866; 248/479–483, 475.1

DESCRIPTION

See application file for complete search history.

FIG. 1 is a first perspective view of a door mirror for motor vehicle;

FIG. 2 is a second perspective view thereof;

FIG. 3 is a front view thereof;

FIG. 4 is a rear view thereof;

FIG. 5 is a left side view thereof;

FIG. 6 is a right side view thereof;

FIG. 7 is a top view thereof; and,

FIG. 8 is a bottom view thereof.

(56) **References Cited**

U.S. PATENT DOCUMENTS

D410,421 S *	6/1999	Pfeiffer	D12/187
D577,639 S *	9/2008	Choi et al.	D12/187
D578,047 S *	10/2008	Kaoud et al.	D12/187
D603,774 S *	11/2009	Chen	D12/187
D605,995 S *	12/2009	Woolley et al.	D12/187
2005/0180032 A1 *	8/2005	Seguchi et al.	359/838
2008/0247068 A1 *	10/2008	Wakabayashi	359/871

1 Claim, 4 Drawing Sheets

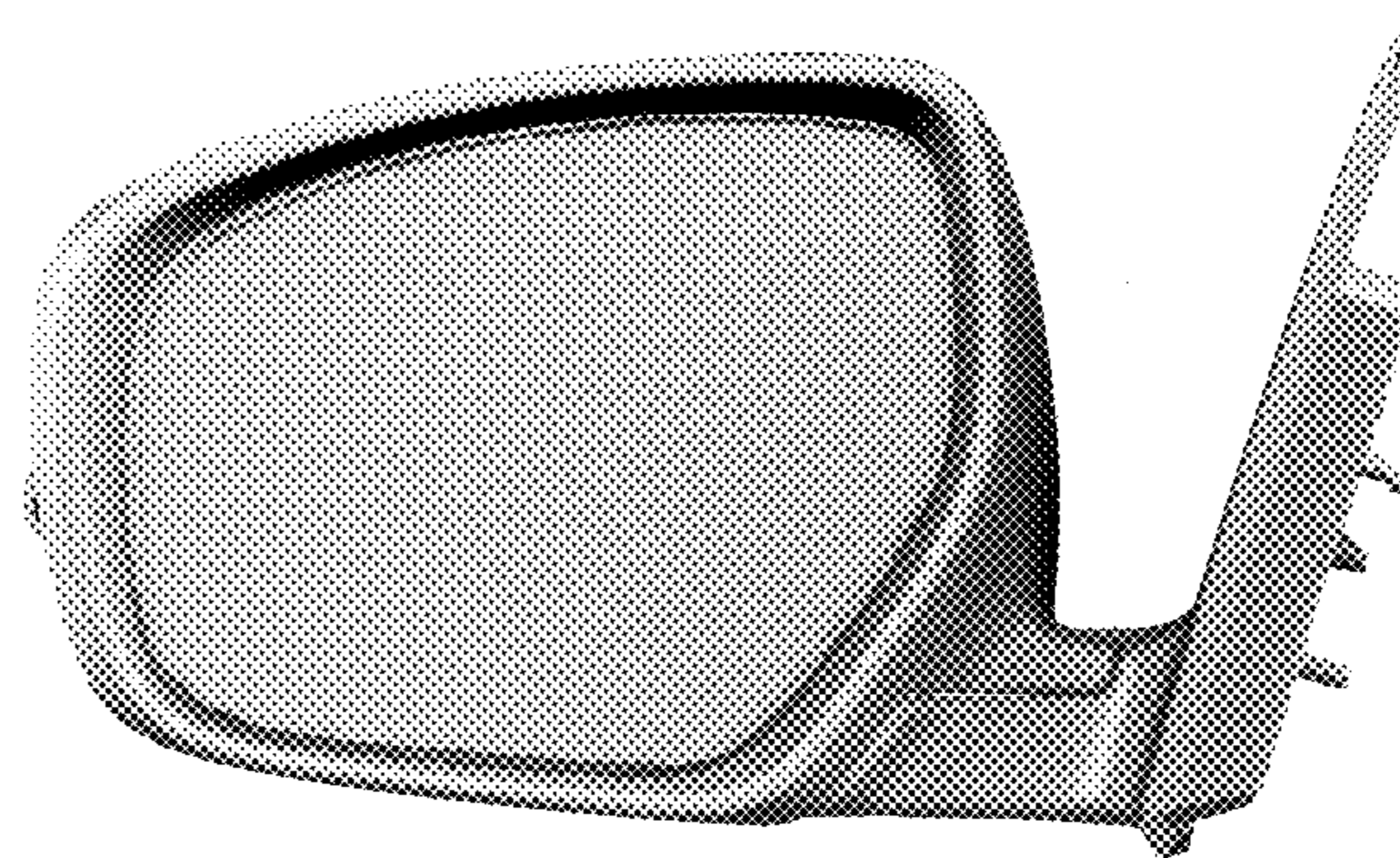
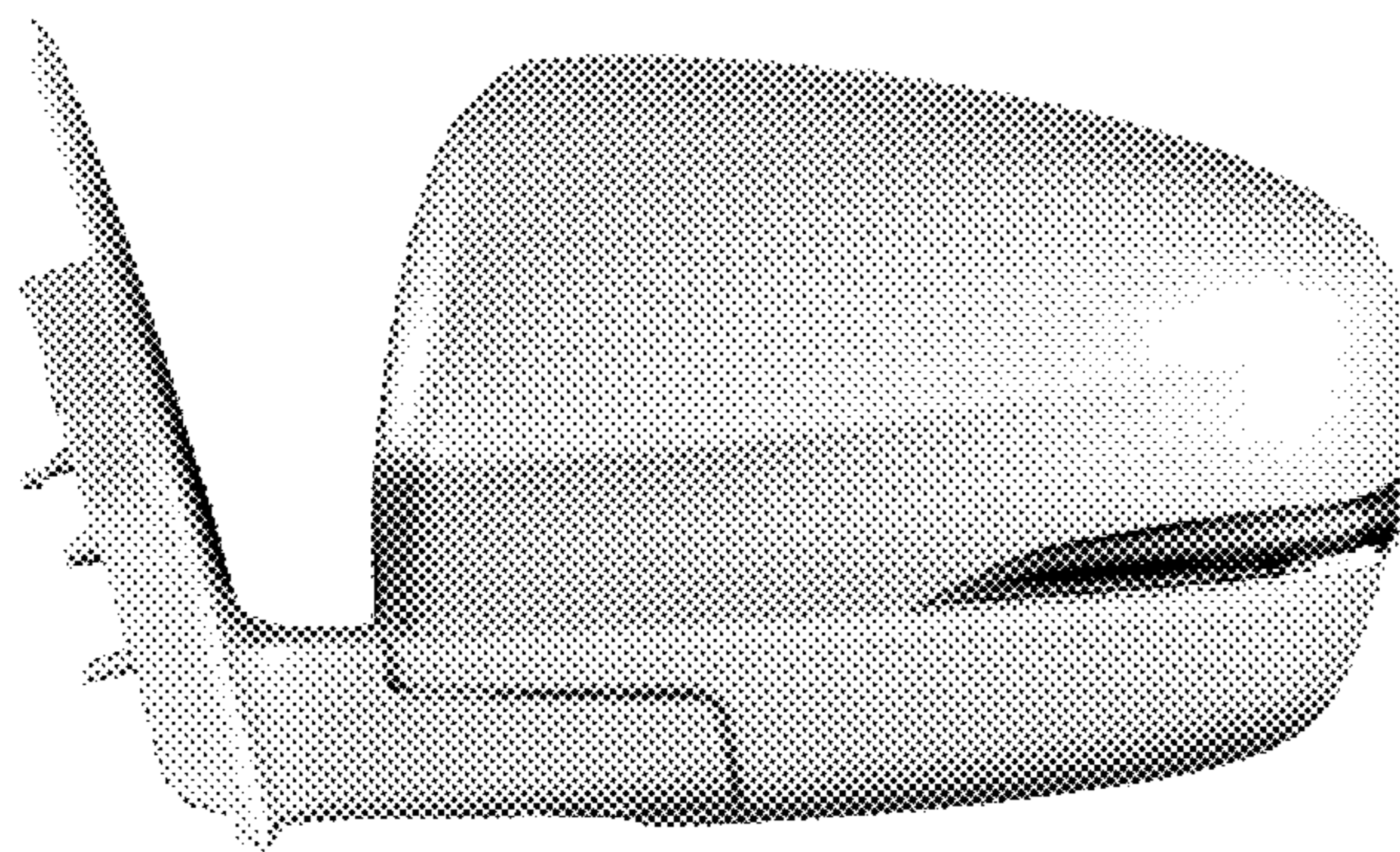

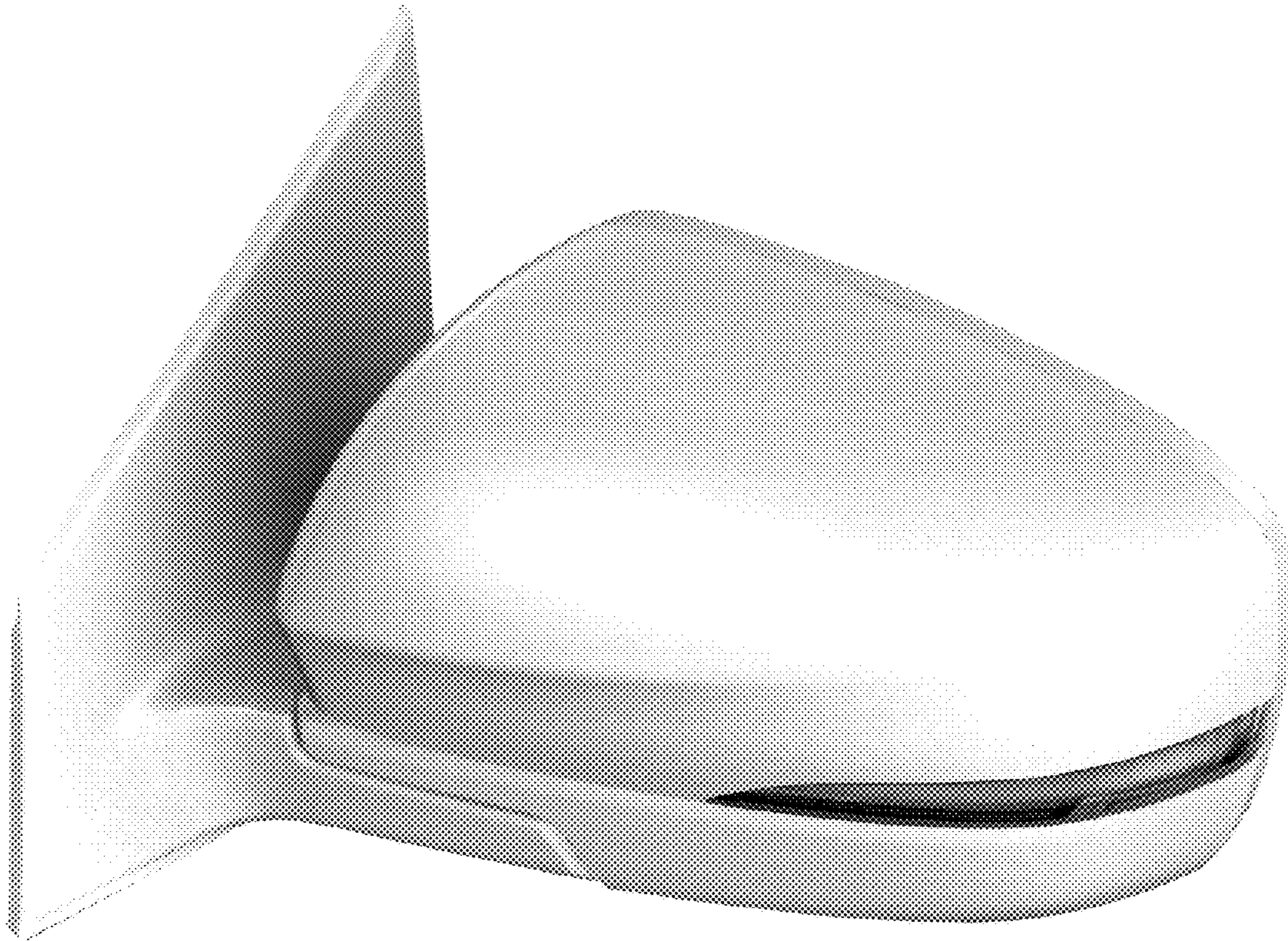
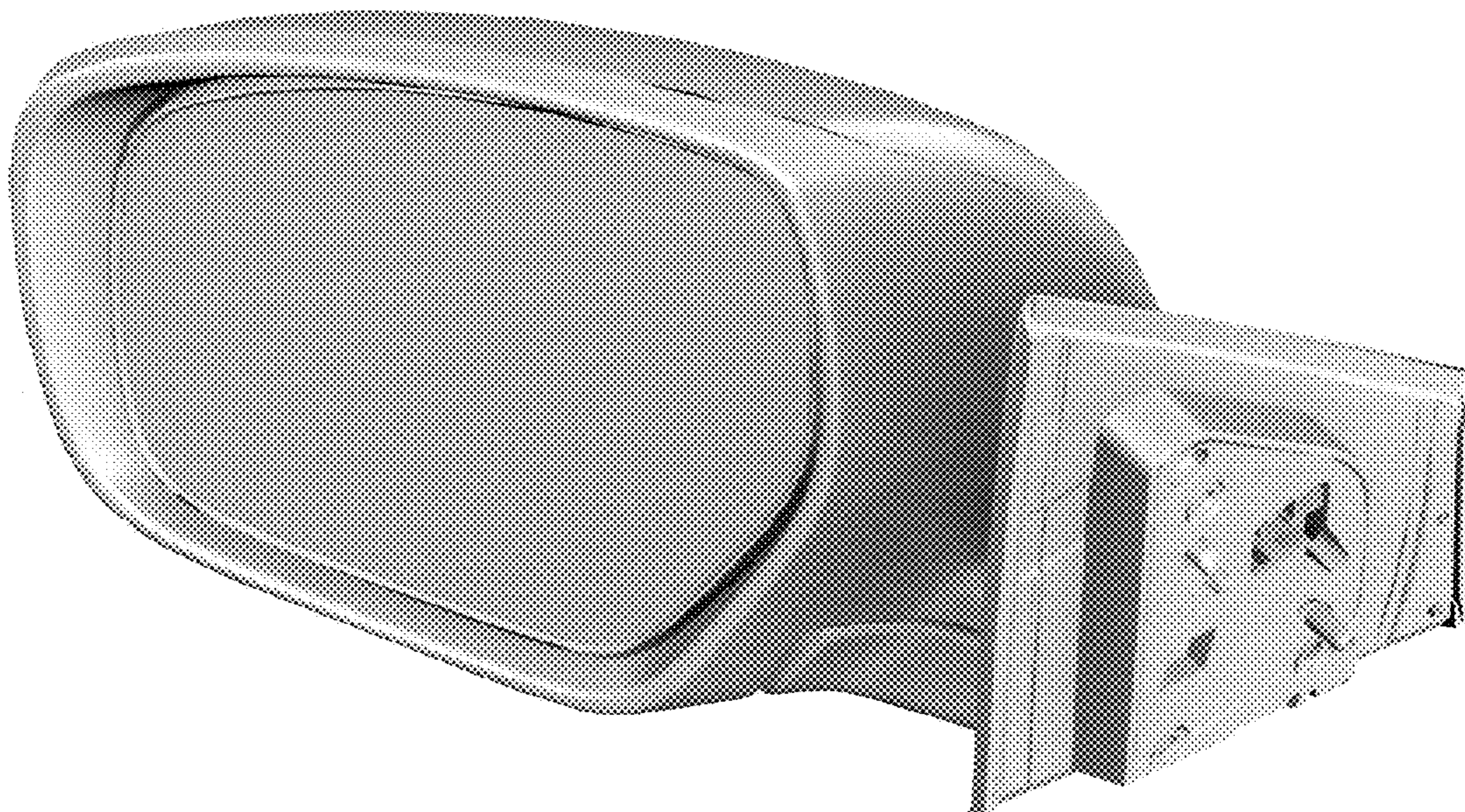

FIG. 1

FIG. 2



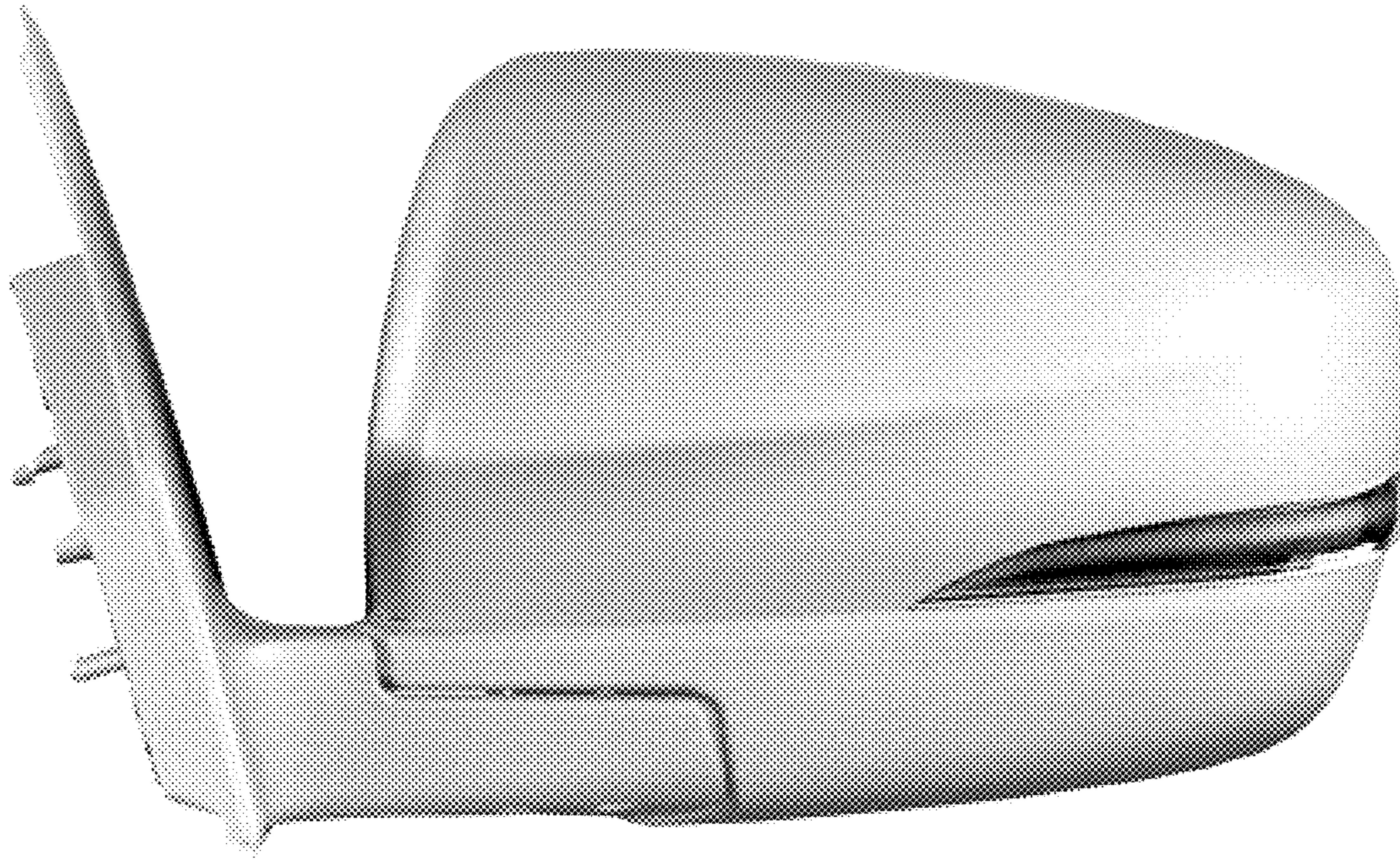
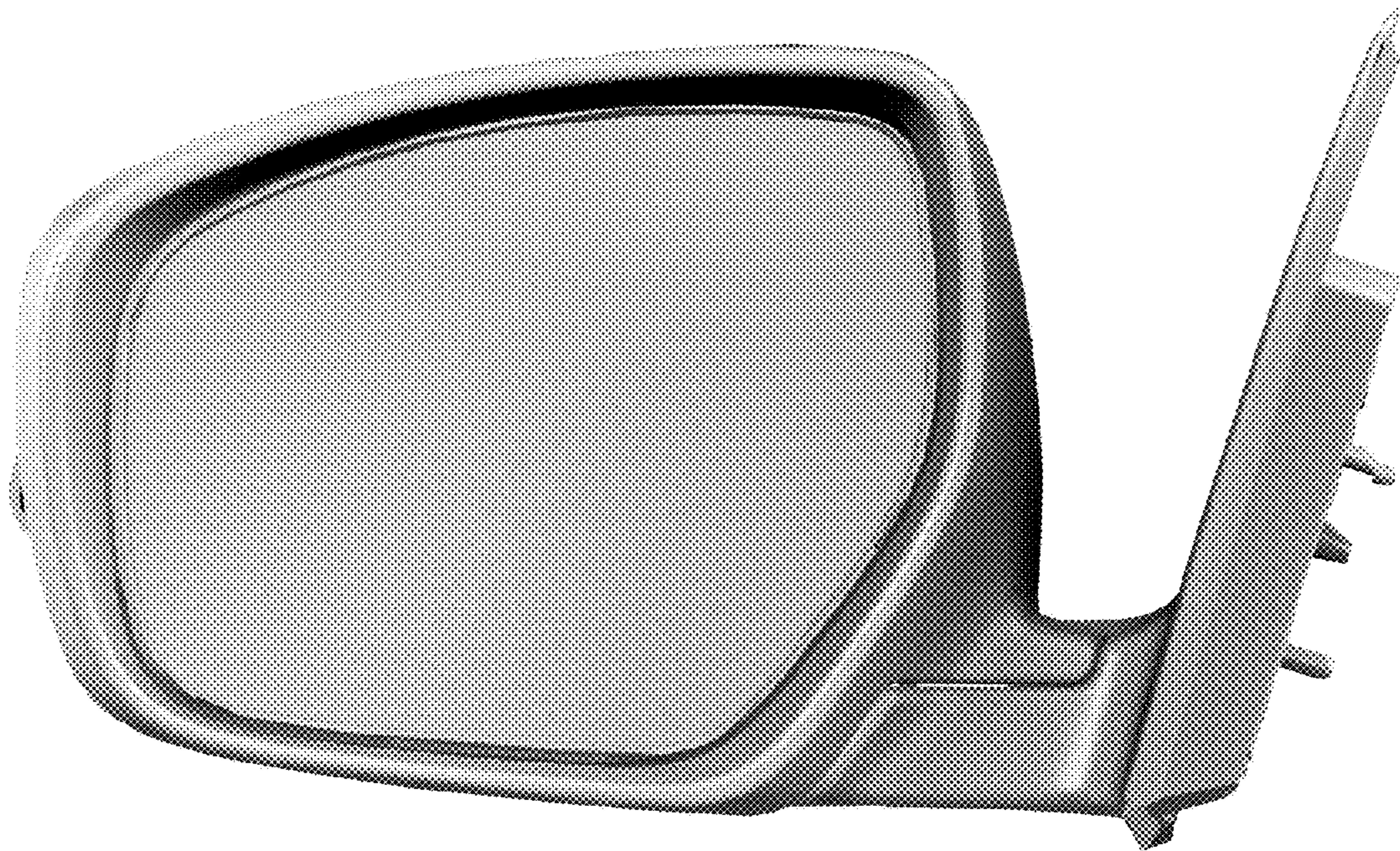

FIG.3

FIG.4



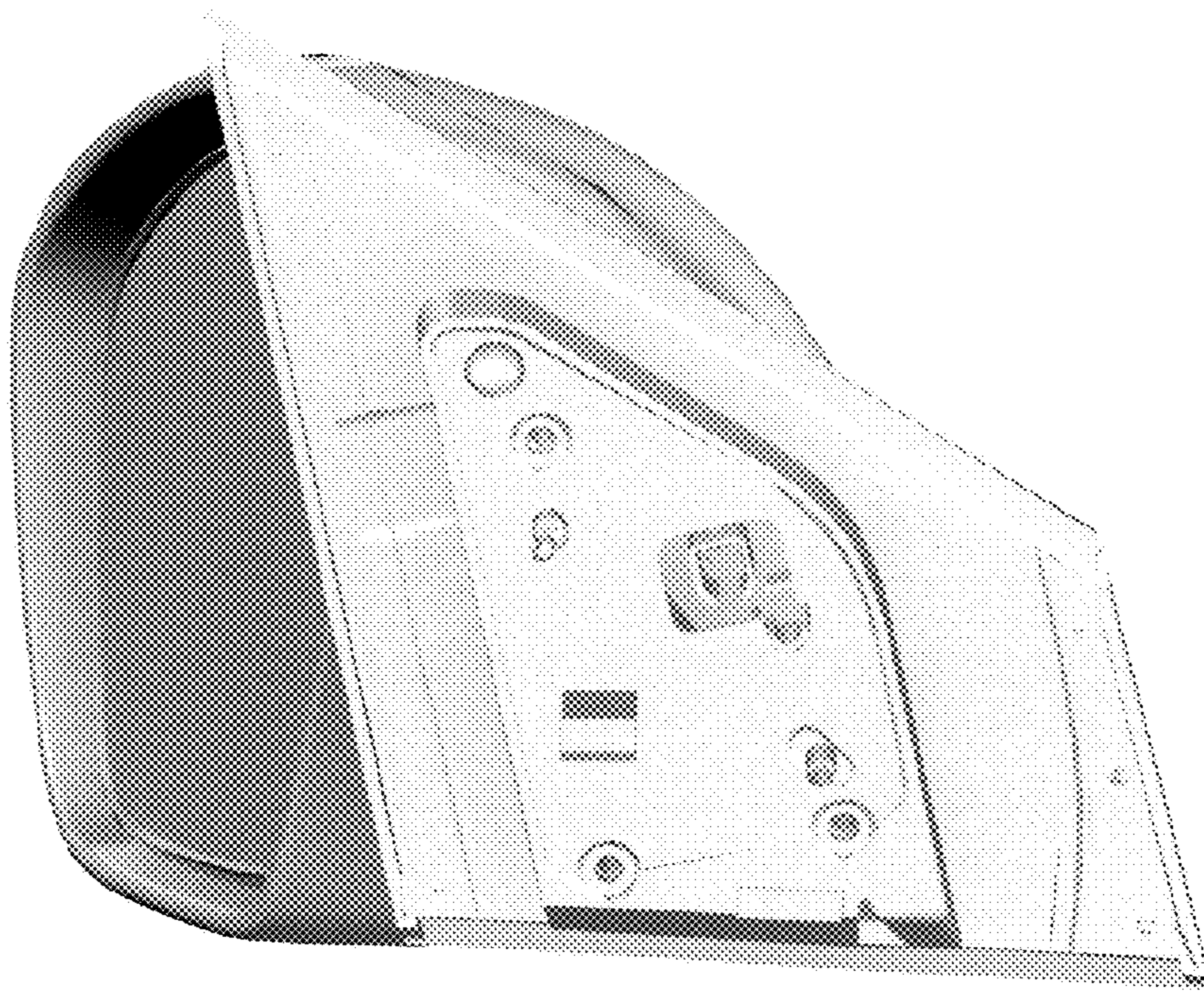
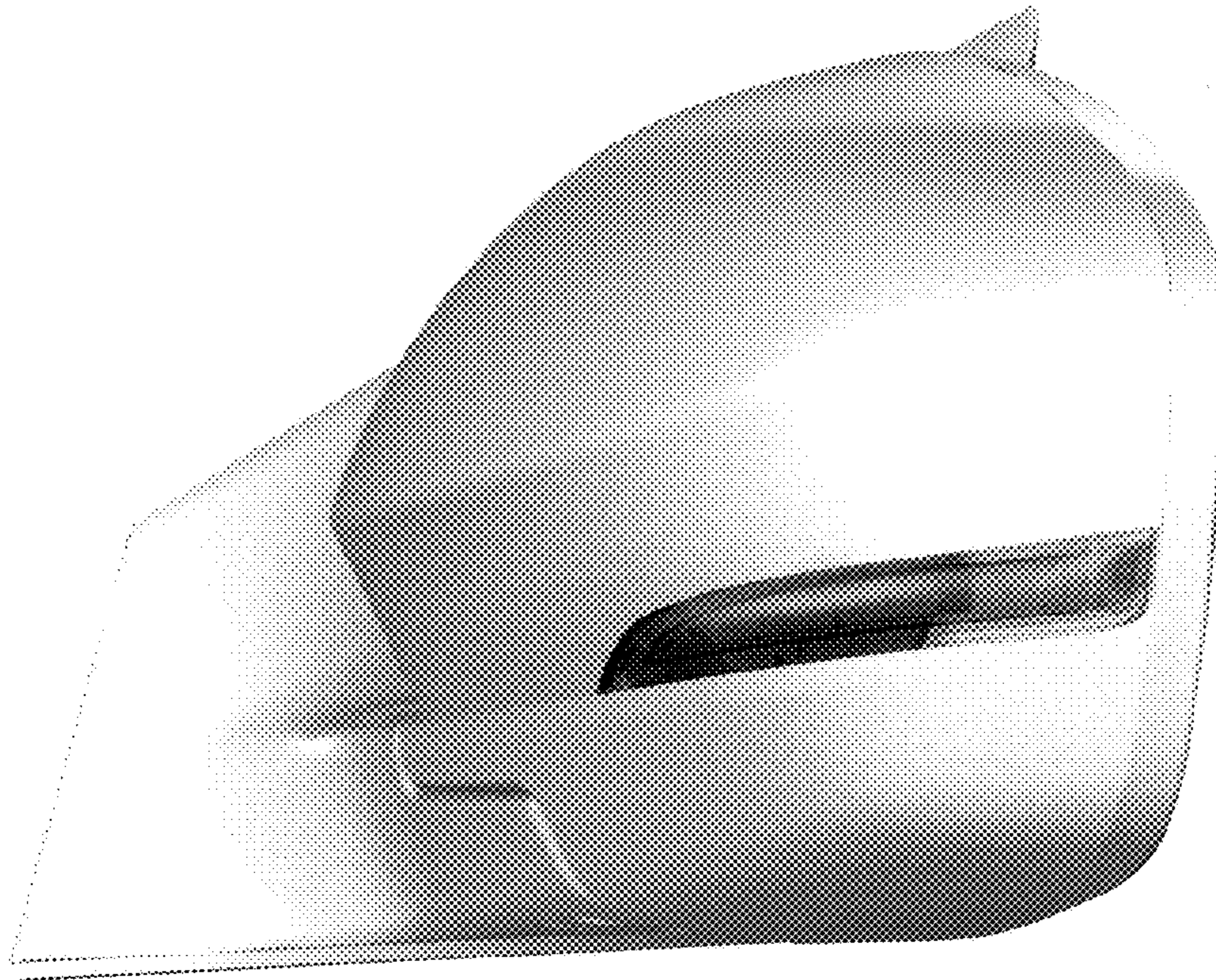

FIG.5

FIG.6



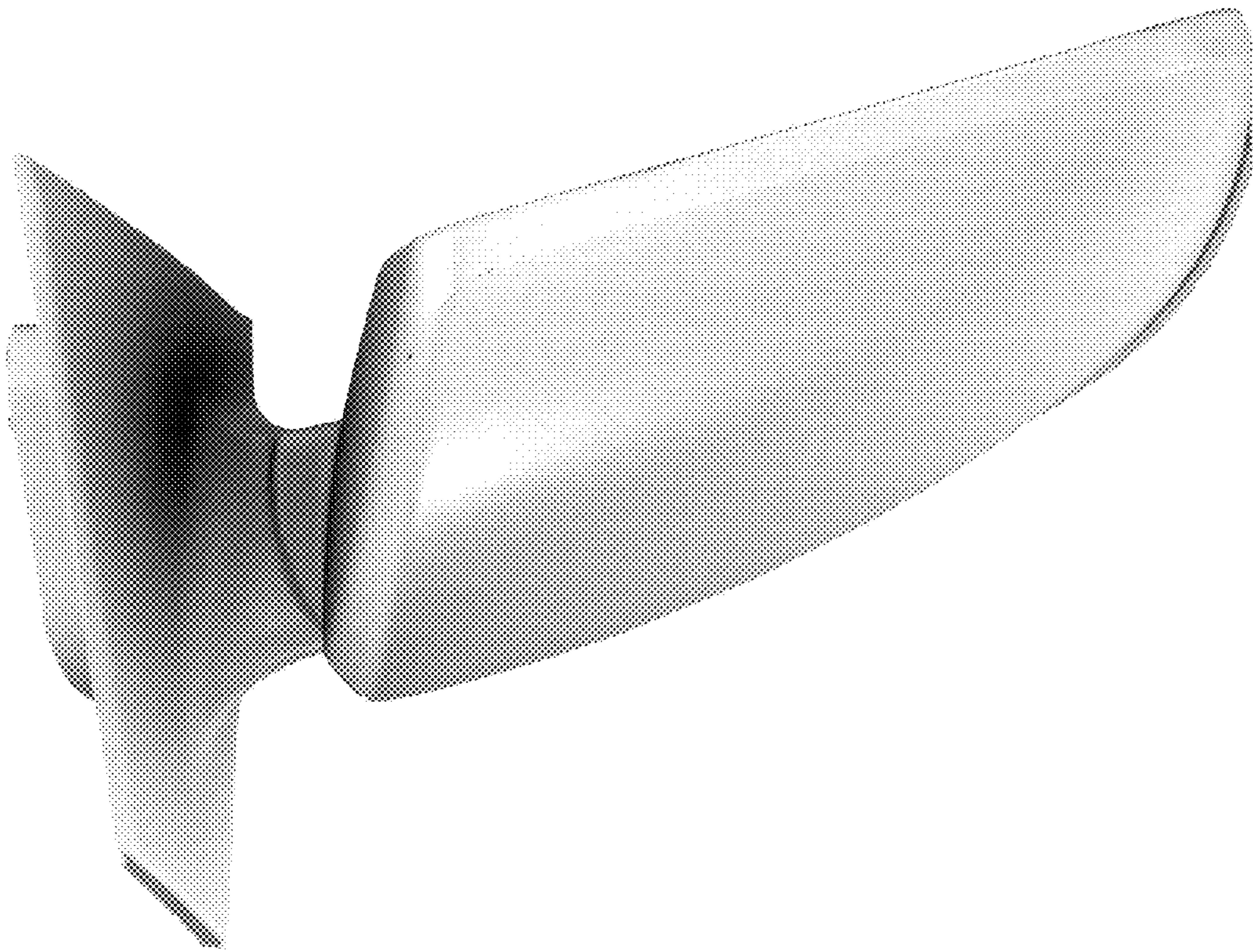

FIG.7

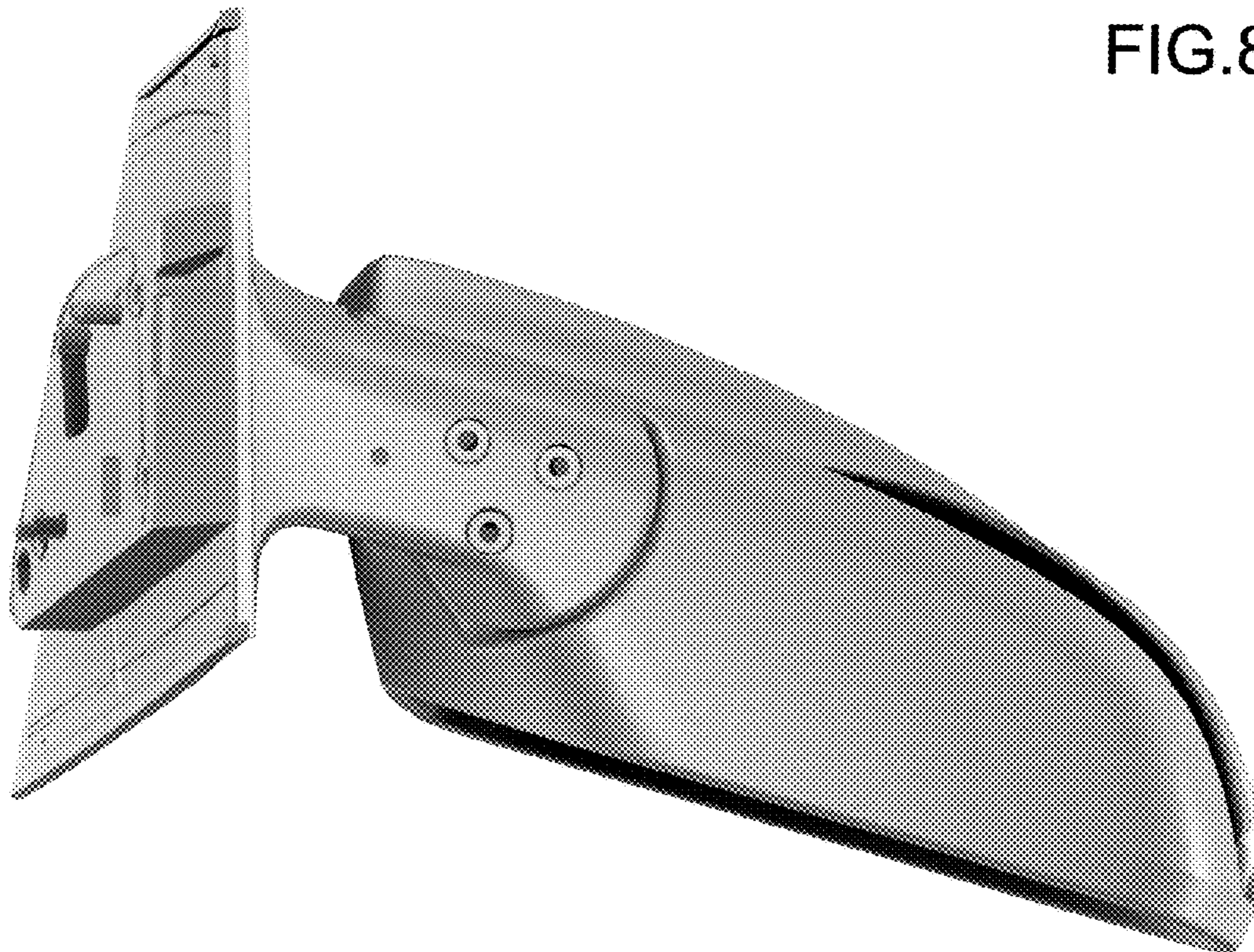

FIG.8