



US00D621283S

(12) **United States Design Patent**  
**Overgaard**

(10) **Patent No.:** **US D621,283 S**

(45) **Date of Patent:** **\*\* Aug. 10, 2010**

(54) **COMBINED BOTTLE, CAP, POURING MECHANISM AND INTERIOR TEMPERATURE REGULATING MECHANISM**

(75) Inventor: **Erik Overgaard**, Oslo (NO)

(73) Assignee: **Reactor Spirits Norway, Ltd.**, Sandvika (NO)

(\*\*) Term: **14 Years**

(21) Appl. No.: **29/329,287**

(22) Filed: **Dec. 11, 2008**

(51) **LOC (9) Cl.** ..... **09-01**

(52) **U.S. Cl.** ..... **D9/719**

(58) **Field of Classification Search** ..... D9/500,  
D9/501, 503-505, 516, 529, 715, 719; D24/107,  
D24/108, 110, 115, 119, 224, 231; 141/22,  
141/24; 215/6, 11.2, 11.4, 17, 18, 400; 222/49;  
604/212, 217

See application file for complete search history.

(56) **References Cited**

**U.S. PATENT DOCUMENTS**

3,101,751	A *	8/1963	Ballin	141/24
5,464,048	A *	11/1995	Allen	141/24
D416,195	S *	11/1999	Faughey et al.	D9/719
D416,793	S *	11/1999	Faughey et al.	D24/110
D435,450	S *	12/2000	Eisenbarth	D9/500
6,273,152	B1 *	8/2001	Buehler et al.	141/22
D474,406	S *	5/2003	Kaposi	D9/505
H2101	H *	5/2004	Faughey et al.	141/22
D491,066	S *	6/2004	Le Goff	D9/500

\* cited by examiner

*Primary Examiner*—Shanda C Hill

(74) *Attorney, Agent, or Firm*—Sherr & Vaughn, PLLC

(57) **CLAIM**

The ornamental design for a “combined bottle, cap, pouring mechanism and interior temperature regulating mechanism,” as shown and described.

**DESCRIPTION**

FIG. 1 is a perspective view of the combined bottle, cap, pouring mechanism and interior temperature mechanism showing my new design;

FIG. 2 is a front elevation view thereof;

FIG. 3 is a rear elevation view thereof;

FIG. 4 is a left side elevation view thereof;

FIG. 5 is a right side elevation view thereof;

FIG. 6 is a top plan view thereof;

FIG. 7 is a bottom plan view thereof;

FIG. 8 bottom plan view of the cap of the combined bottle, cap, pouring mechanism and interior temperature mechanism;

FIG. 9 is a perspective view thereof;

FIG. 10 is a perspective view of the pouring mechanism and the interior temperature mechanism of the combined bottle, cap, pouring mechanism and interior temperature mechanism;

FIG. 11 is a front elevation view thereof;

FIG. 12 is a rear elevation view thereof;

FIG. 13 is a left side elevation view thereof;

FIG. 14 is a right side elevation view thereof;

FIG. 15 is a top plan view thereof; and,

FIG. 16 is a bottom plan view thereof.

**1 Claim, 9 Drawing Sheets**

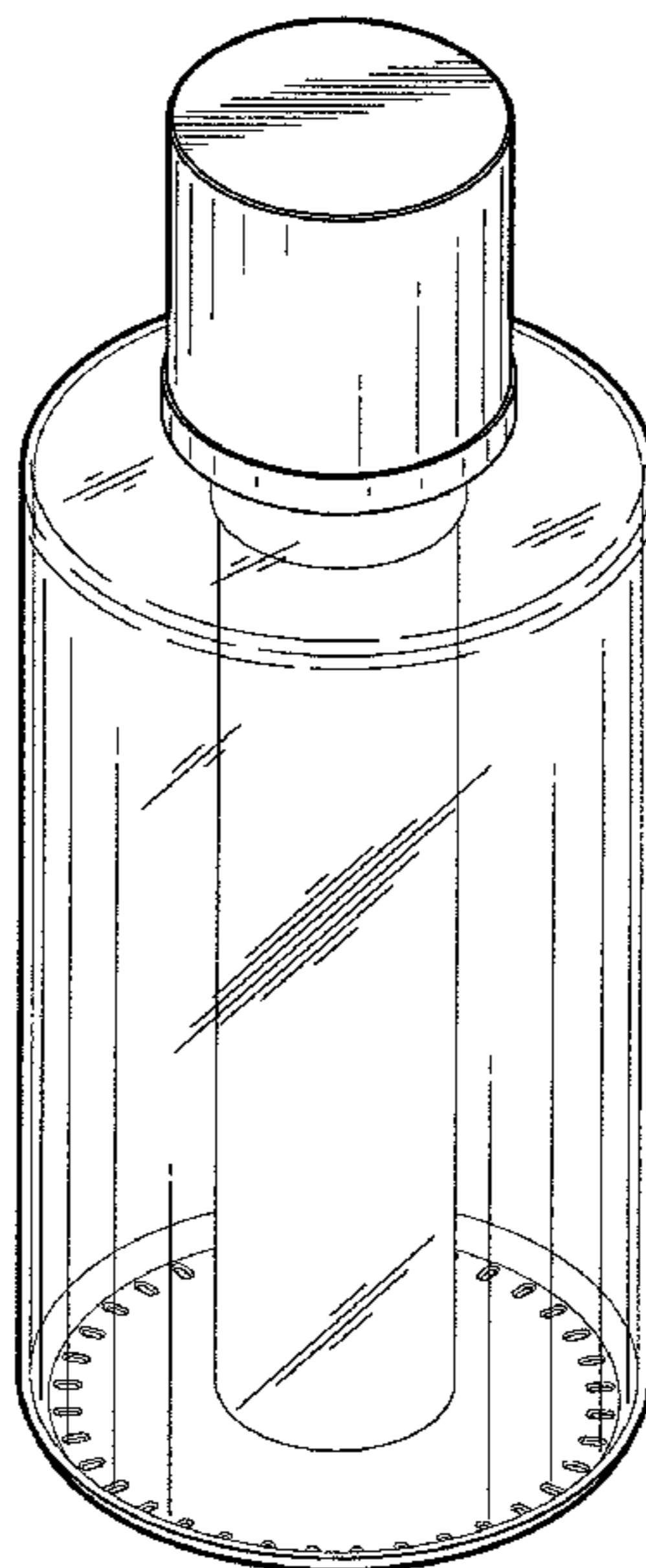
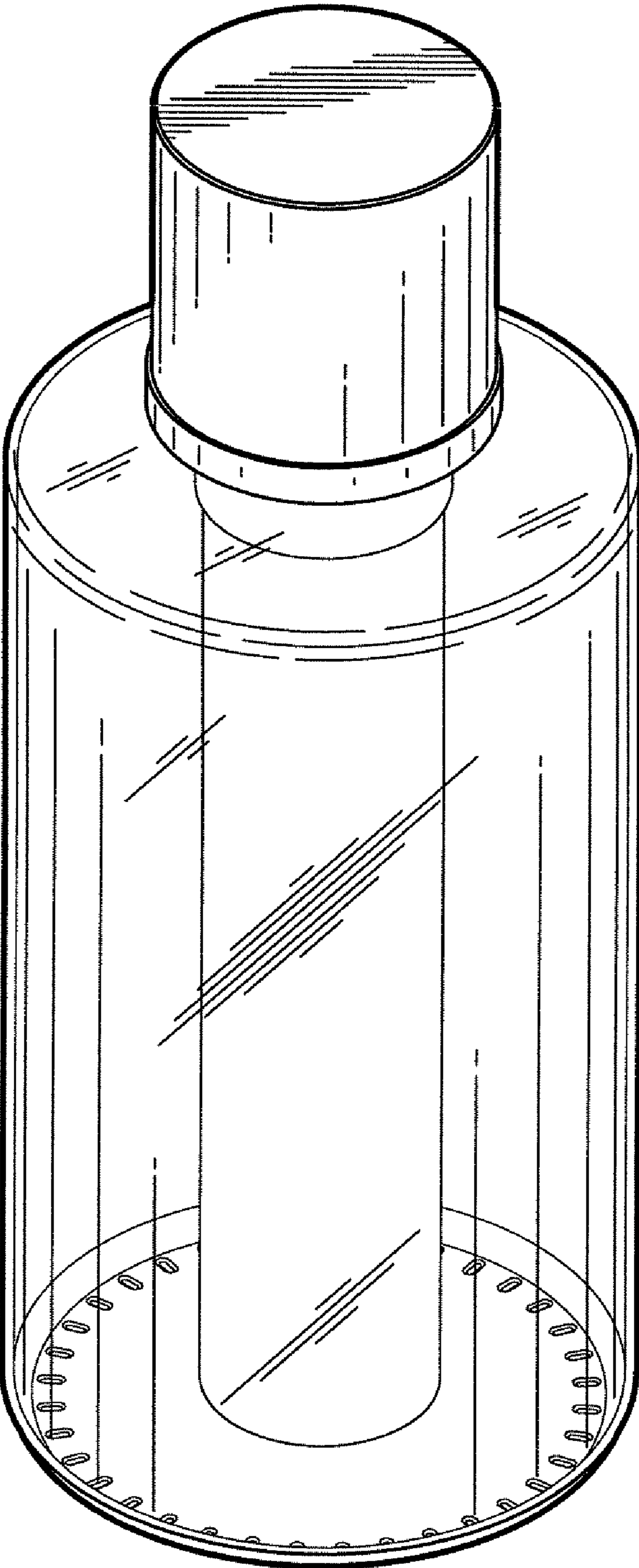

Fig. 1



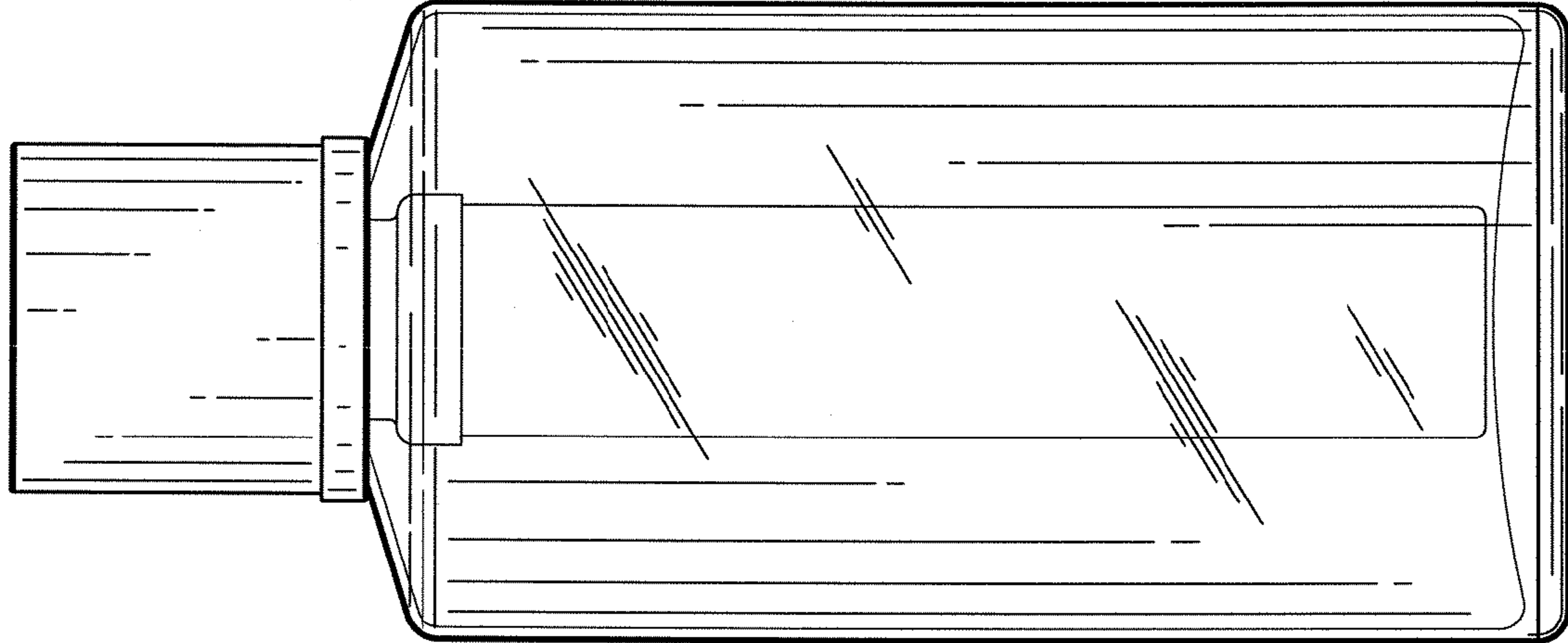

Fig. 3

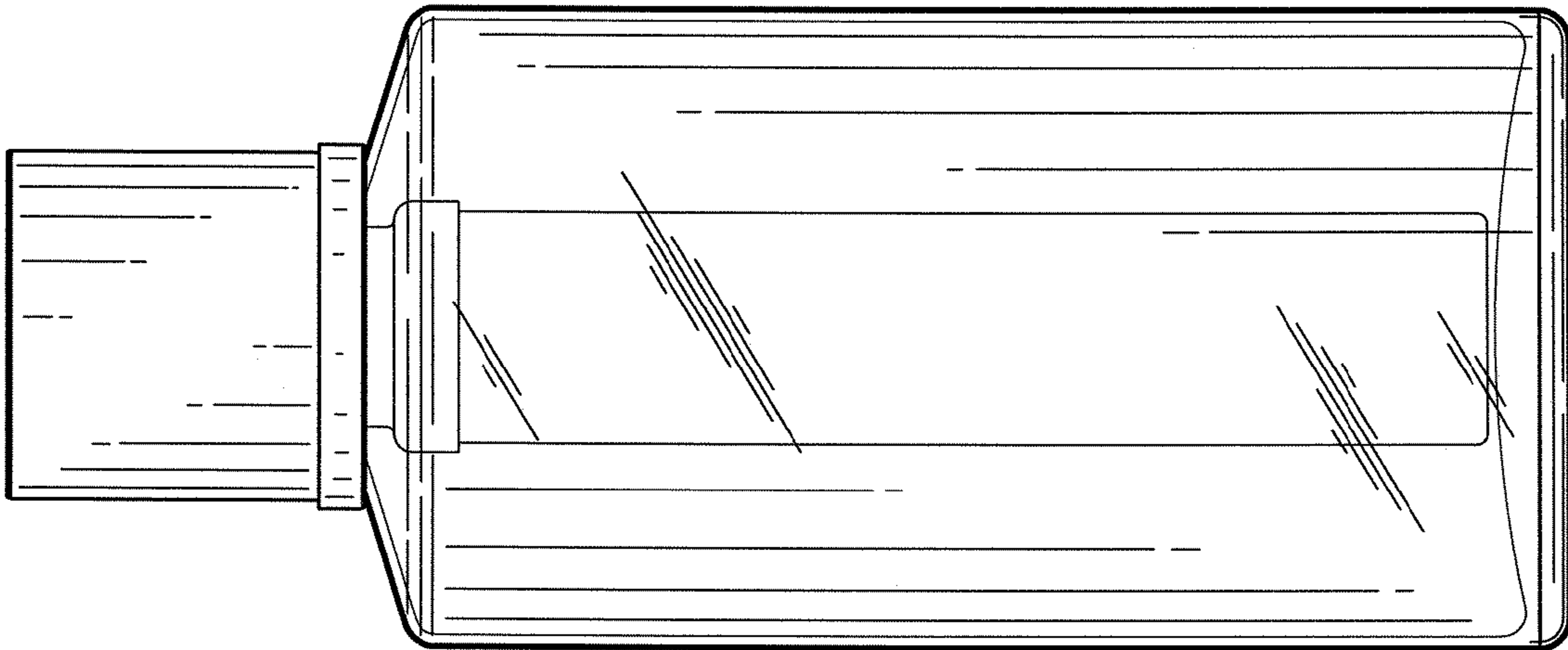

Fig. 2

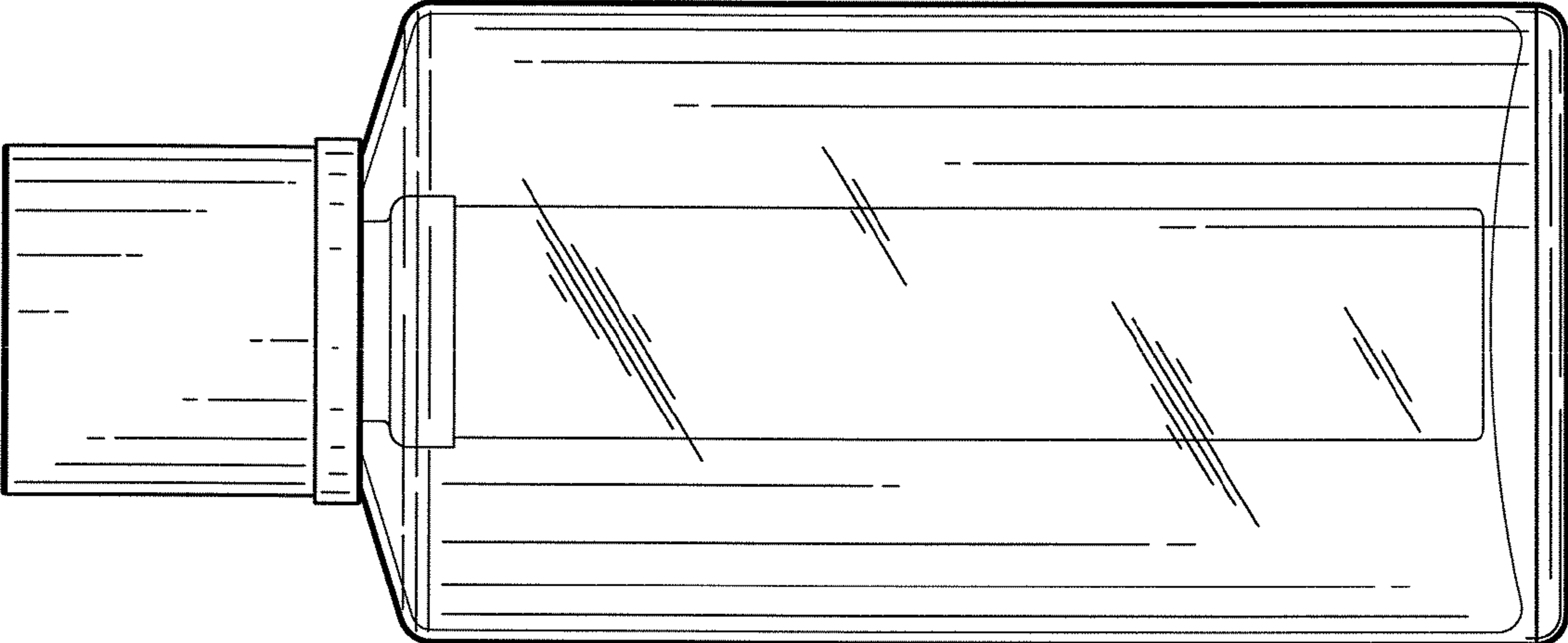

Fig. 5

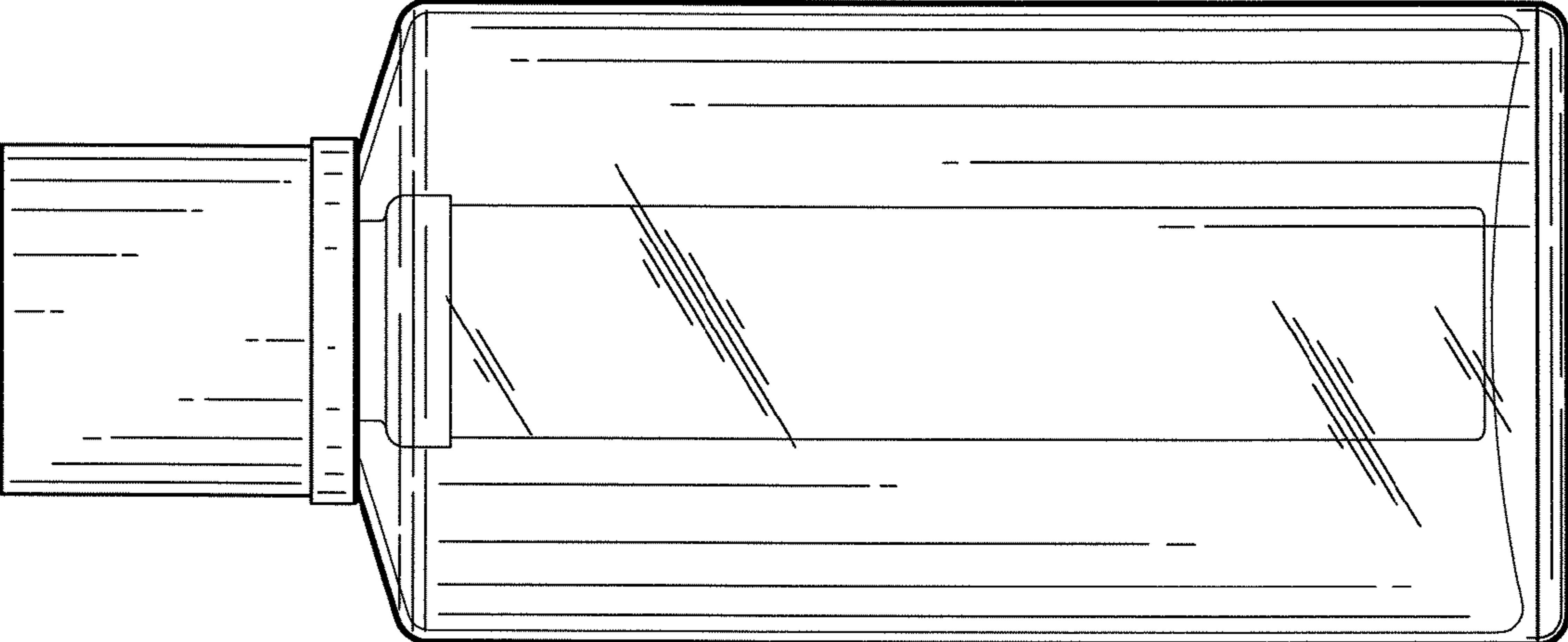

Fig. 4

Fig. 6

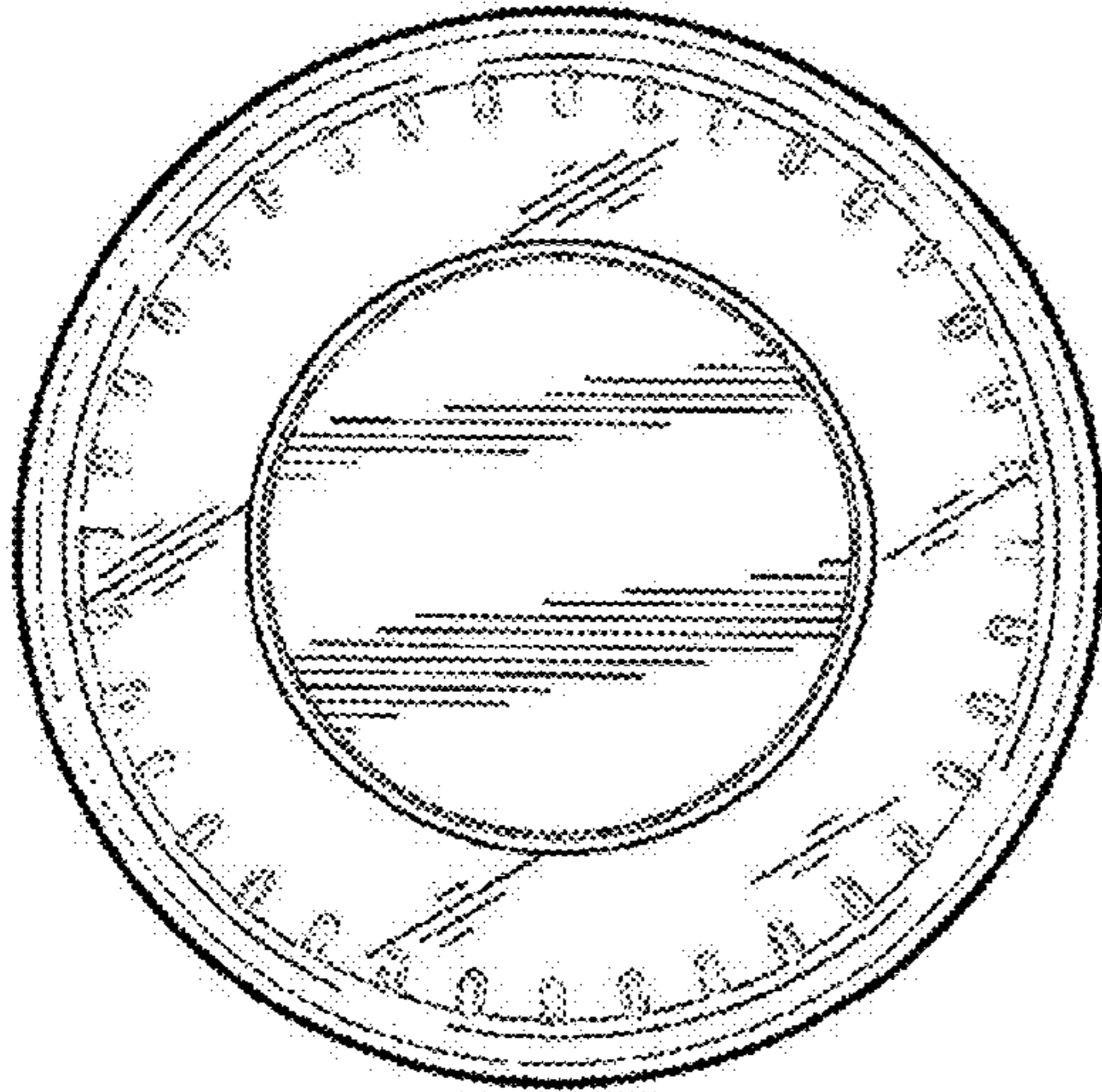

Fig. 7

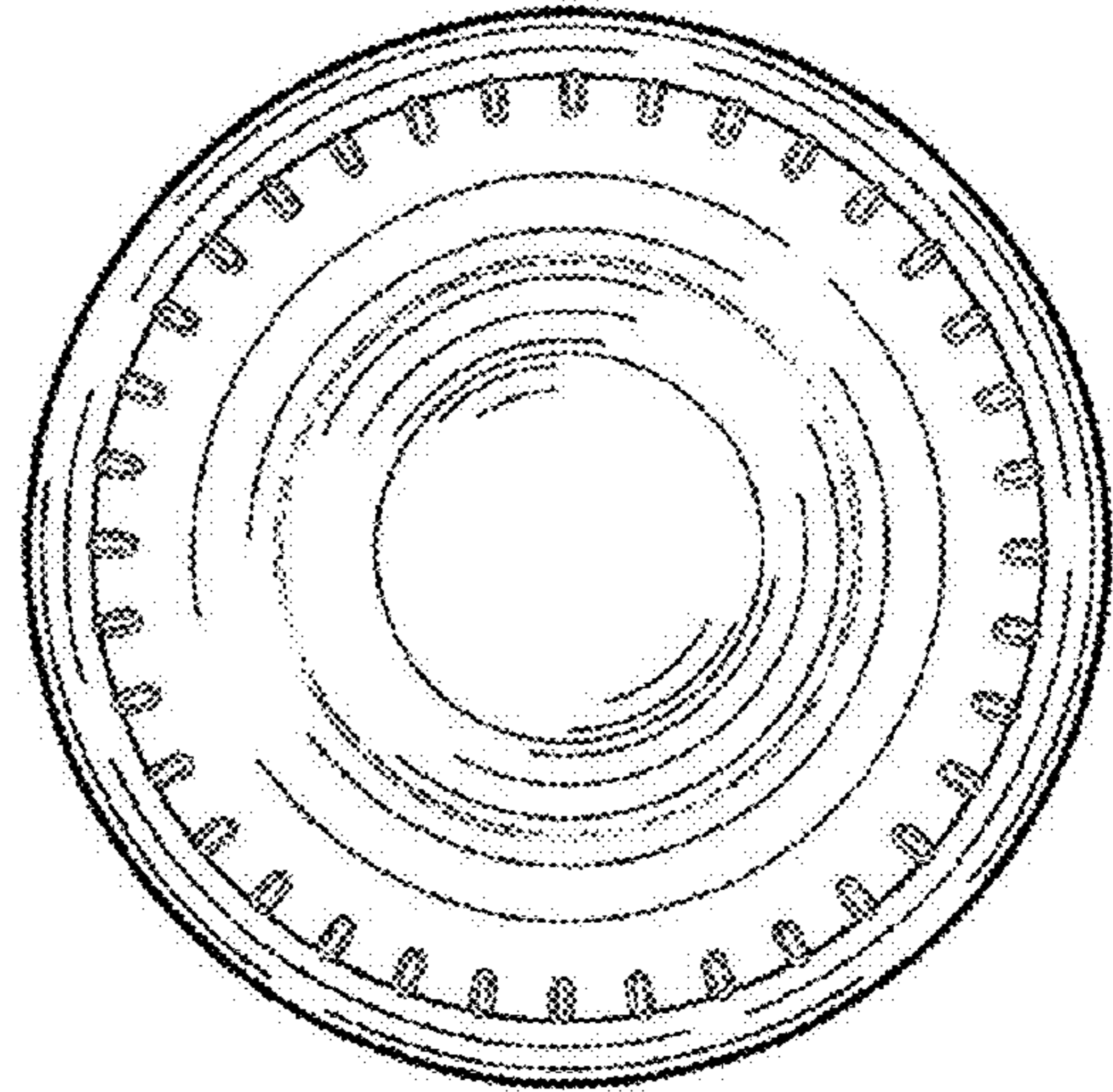

Fig. 8

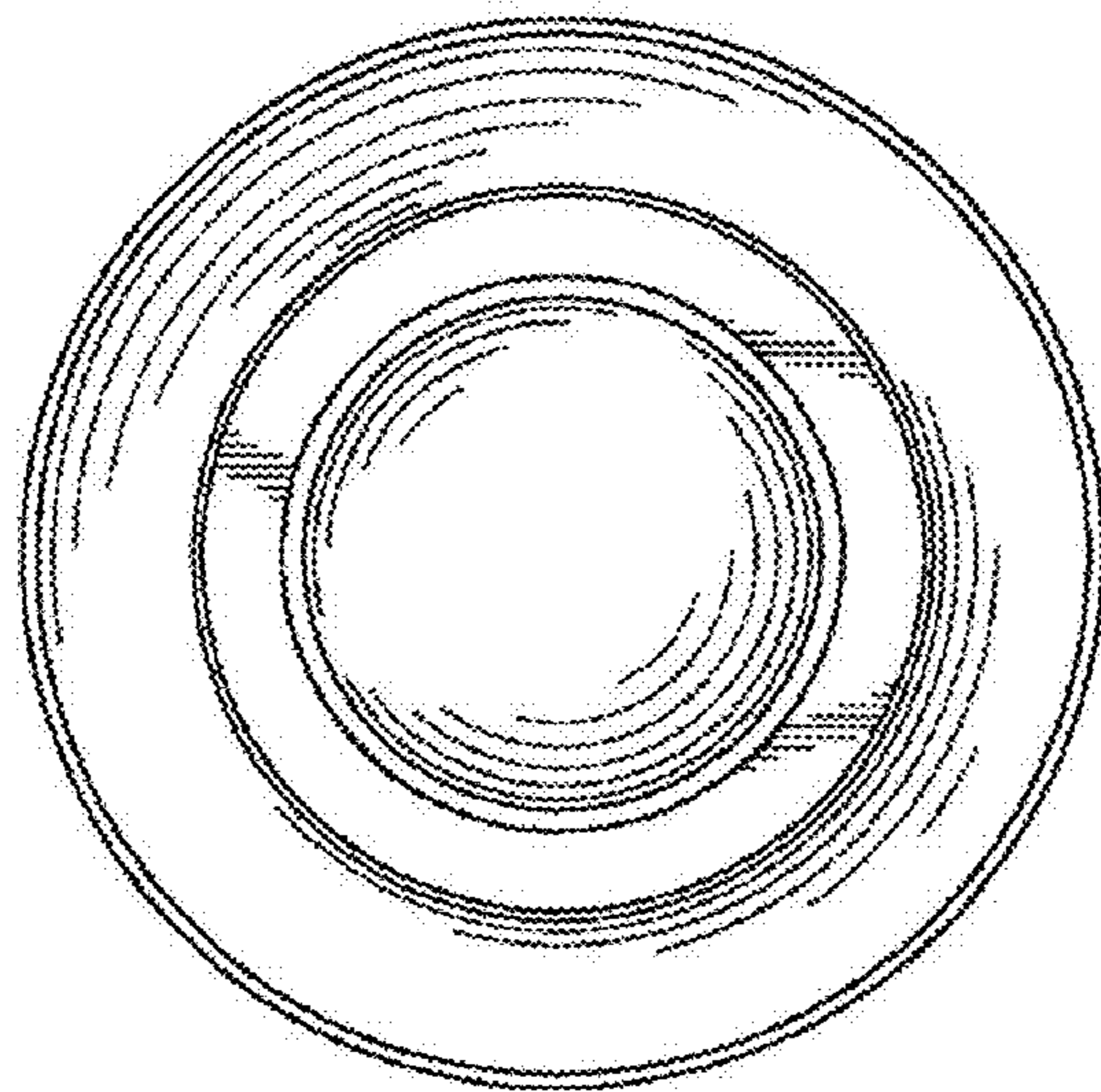

Fig. 9

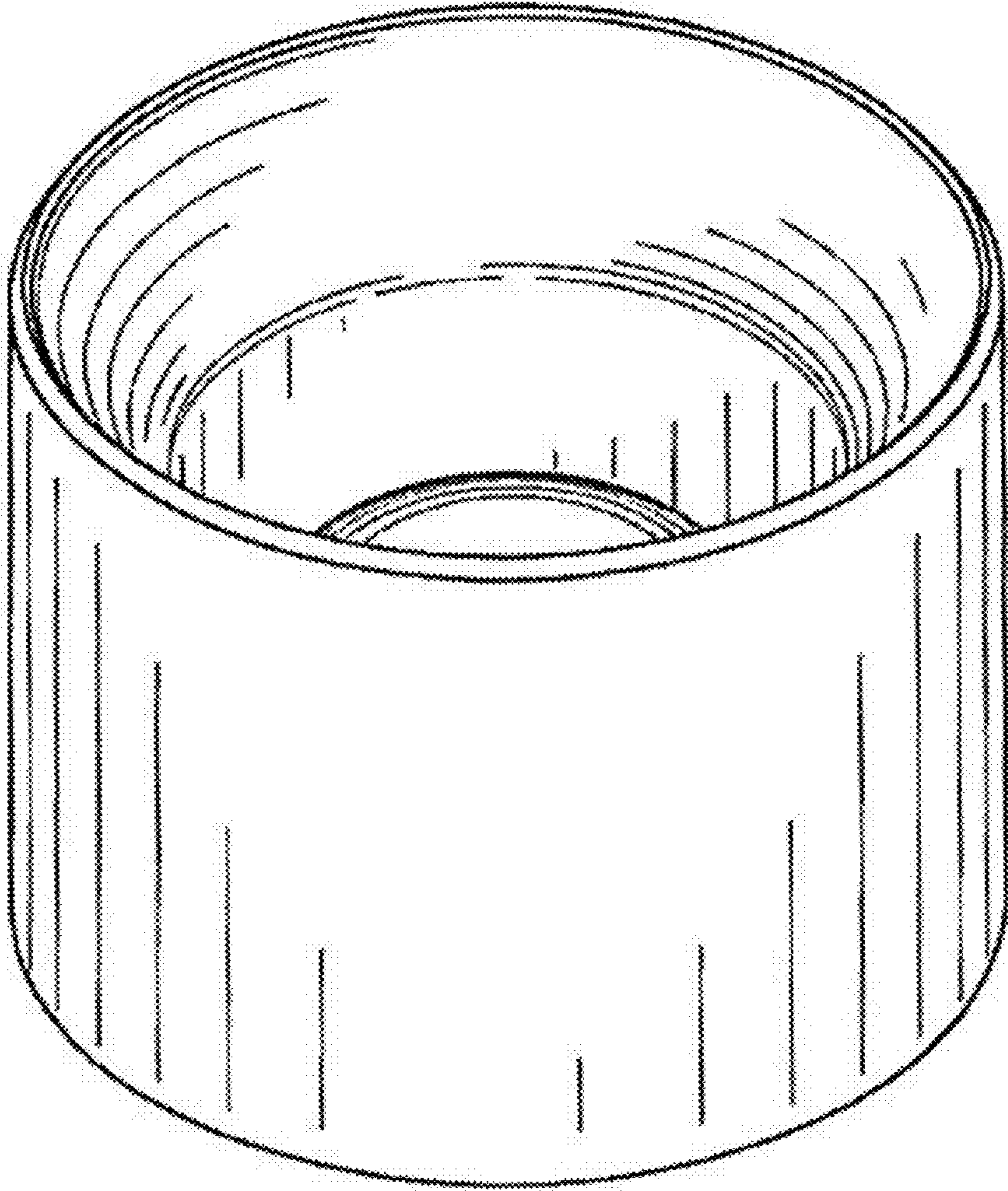
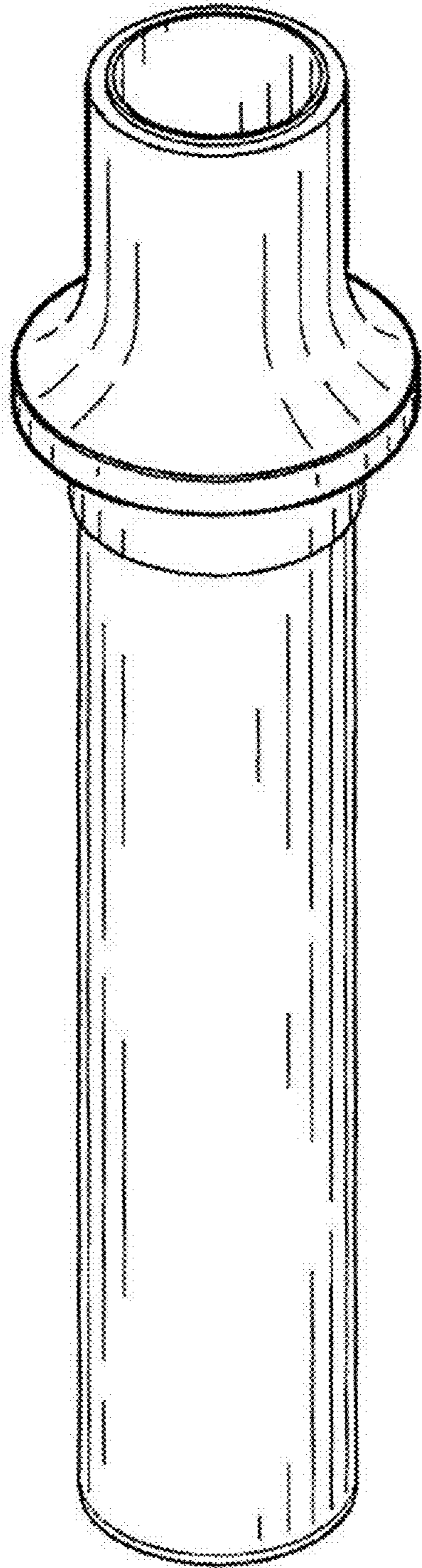

Fig. 10



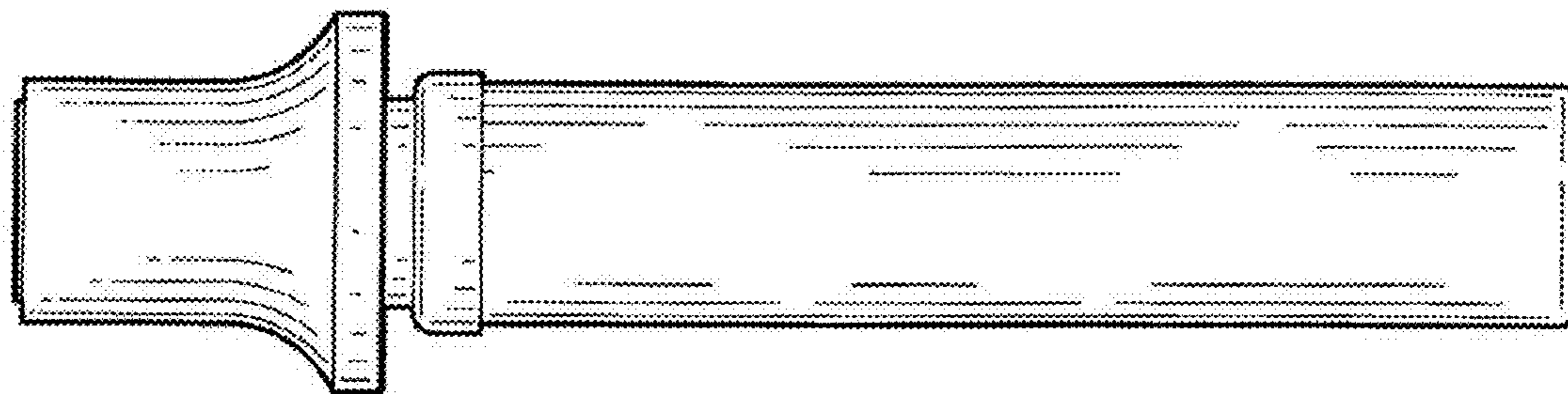

Fig. 12

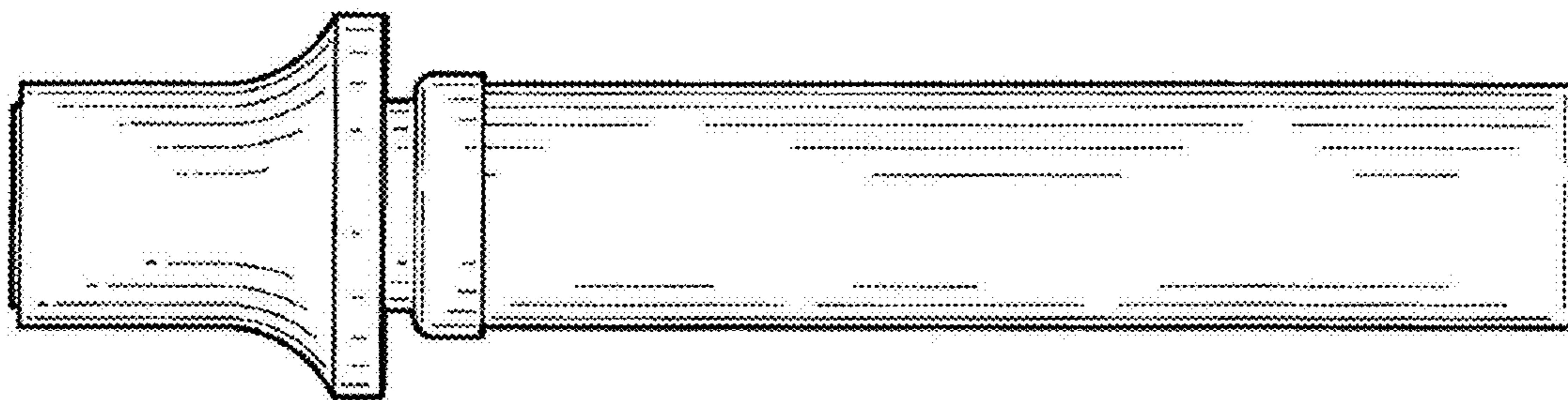

Fig. 11



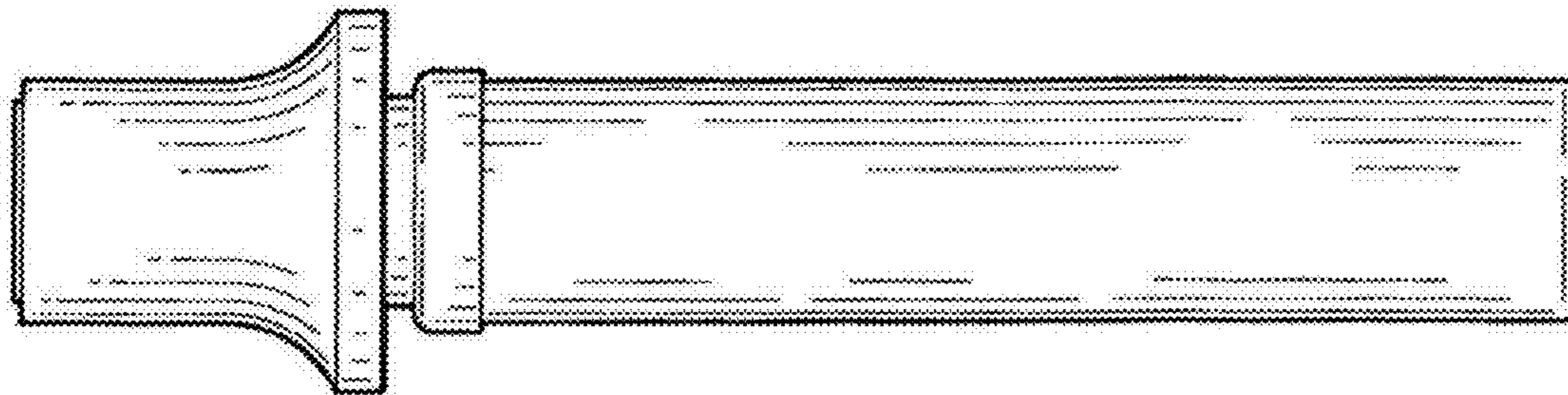

Fig. 14



Fig. 13

Fig. 15

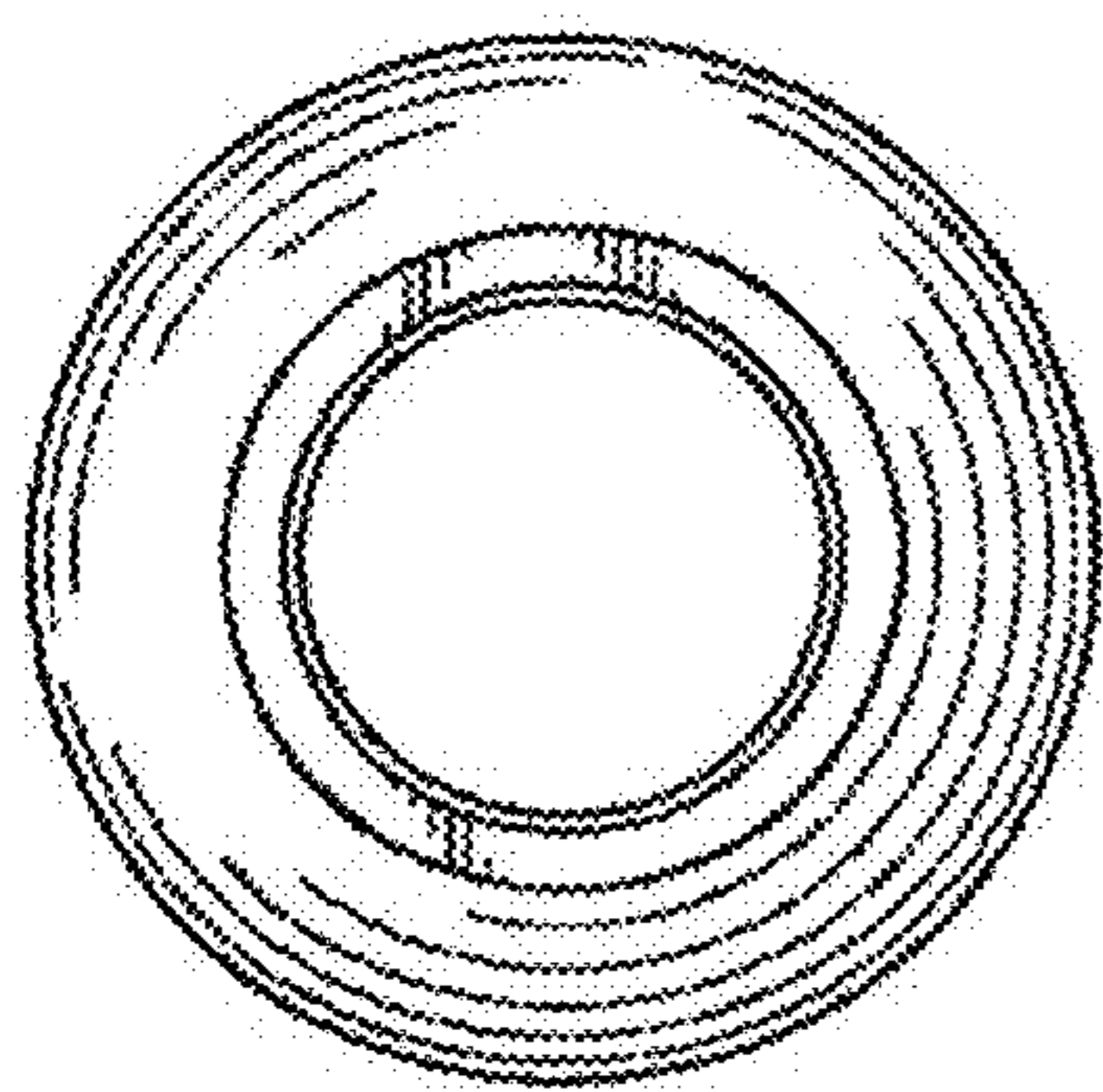

Fig. 16

