



US00D621242S

(12) **United States Design Patent**
Gois, Sr.

(10) **Patent No.:** **US D621,242 S**

(45) **Date of Patent:** **** Aug. 10, 2010**

(54) **PURSE RING WITH EXTENDED APERTURE**

(76) Inventor: **John F. Gois, Sr.**, 4803 La Cruz Dr., La Mesa, CA (US) 91941

(**) Term: **14 Years**

(21) Appl. No.: **29/346,047**

(22) Filed: **Oct. 26, 2009**

(51) **LOC (9) Cl.** **08-05**

(52) **U.S. Cl.** **D8/367**

(58) **Field of Classification Search** D8/367;
24/598.3, 579.11, 600.1-600.2, 600.9, 600.4
See application file for complete search history.

(56) **References Cited**

U.S. PATENT DOCUMENTS

5,287,645 A * 2/1994 Gois 43/14
5,505,013 A * 4/1996 Gois 43/14

* cited by examiner

Primary Examiner—Holly H Baynham
(74) *Attorney, Agent, or Firm*—Nydegger & Associates

(57) **CLAIM**

The ornamental design for a purse ring with extended aperture, as shown.

DESCRIPTION

FIG. 1 is a top plan view of the purse ring with its sleeve positioned to establish an enclosed aperture;
FIG. 2 is a front view of the purse ring;
FIG. 3 is a rear view of the purse ring;
FIG. 4 is a right side view of the purse ring;
FIG. 5 is a left side view of the purse ring;
FIG. 6 is a bottom view of the purse ring; and,
FIG. 7 is a top plan view of the purse ring with its sleeve repositioned to provide access into the aperture.

1 Claim, 2 Drawing Sheets

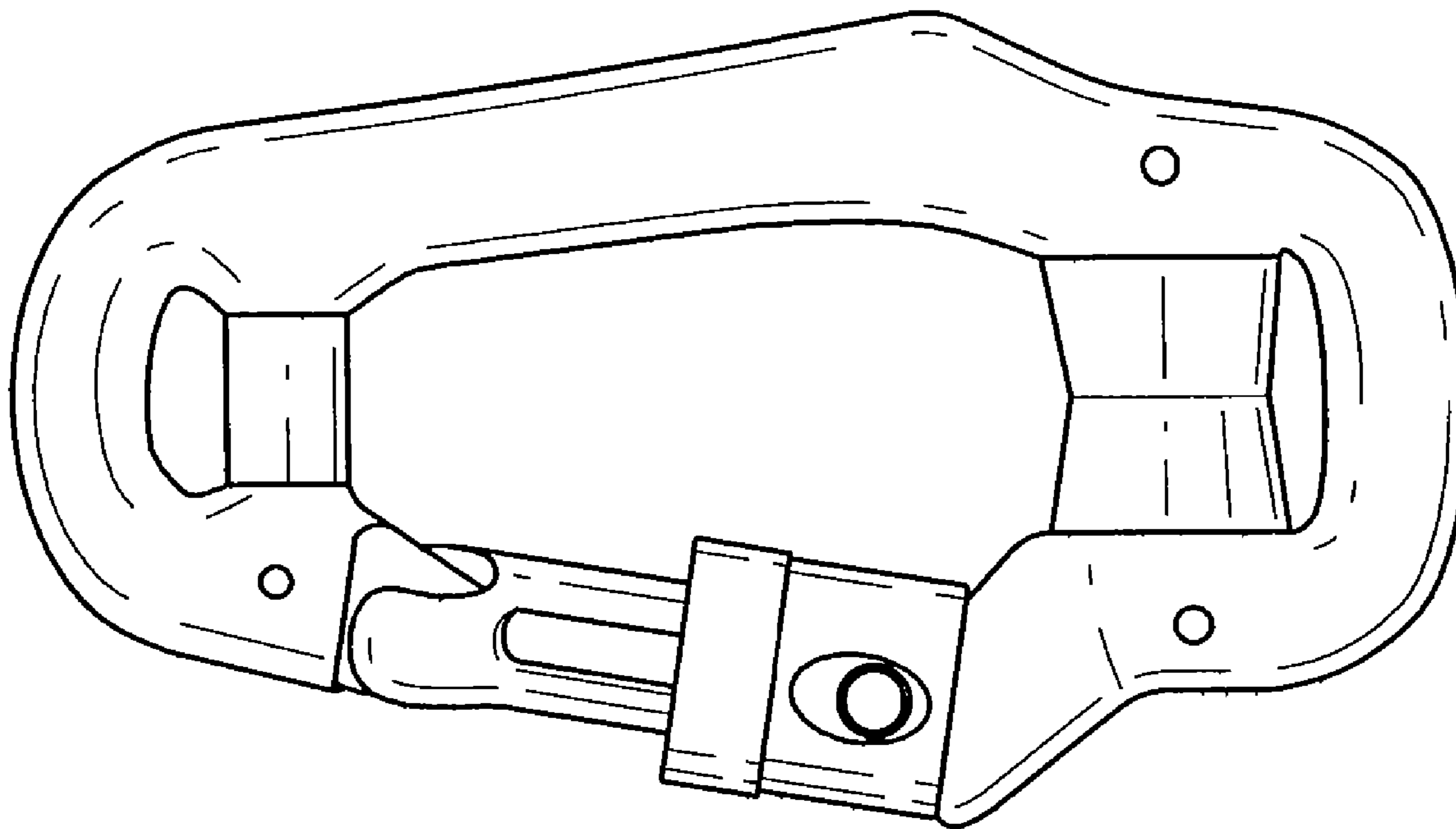

FIG. 1

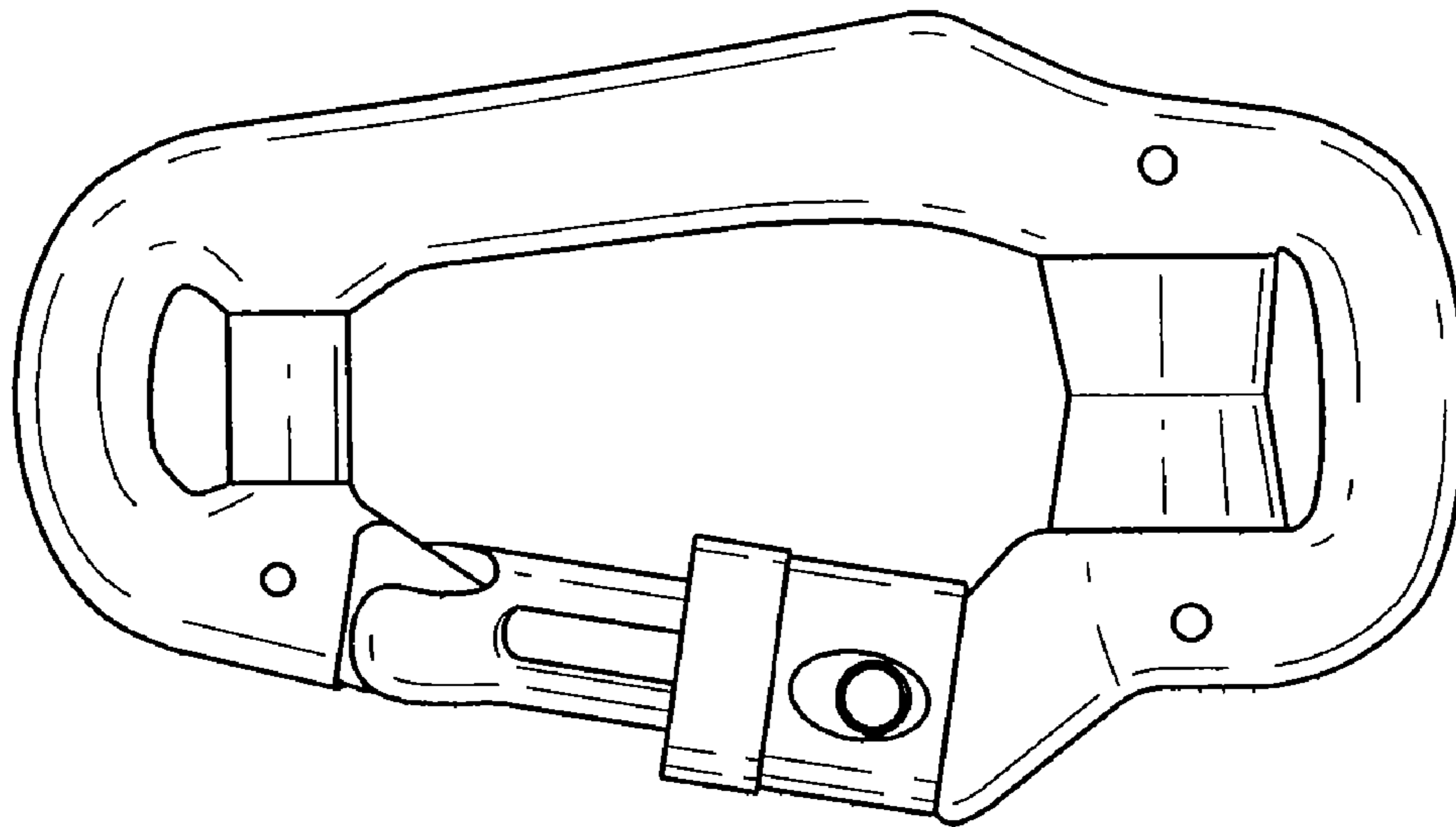

FIG. 2

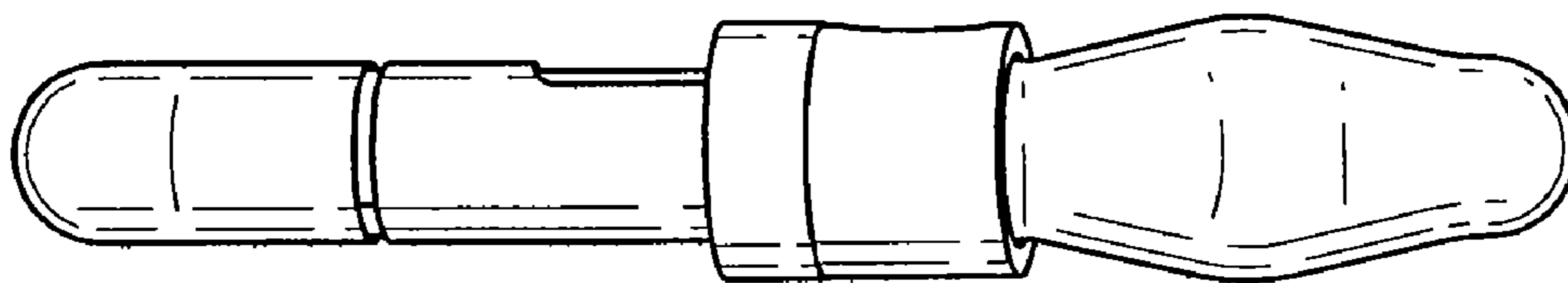

FIG. 3

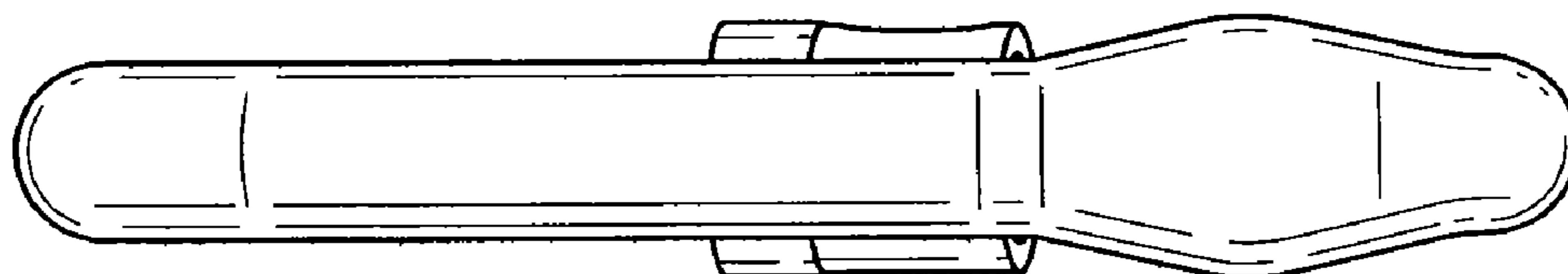

FIG. 4

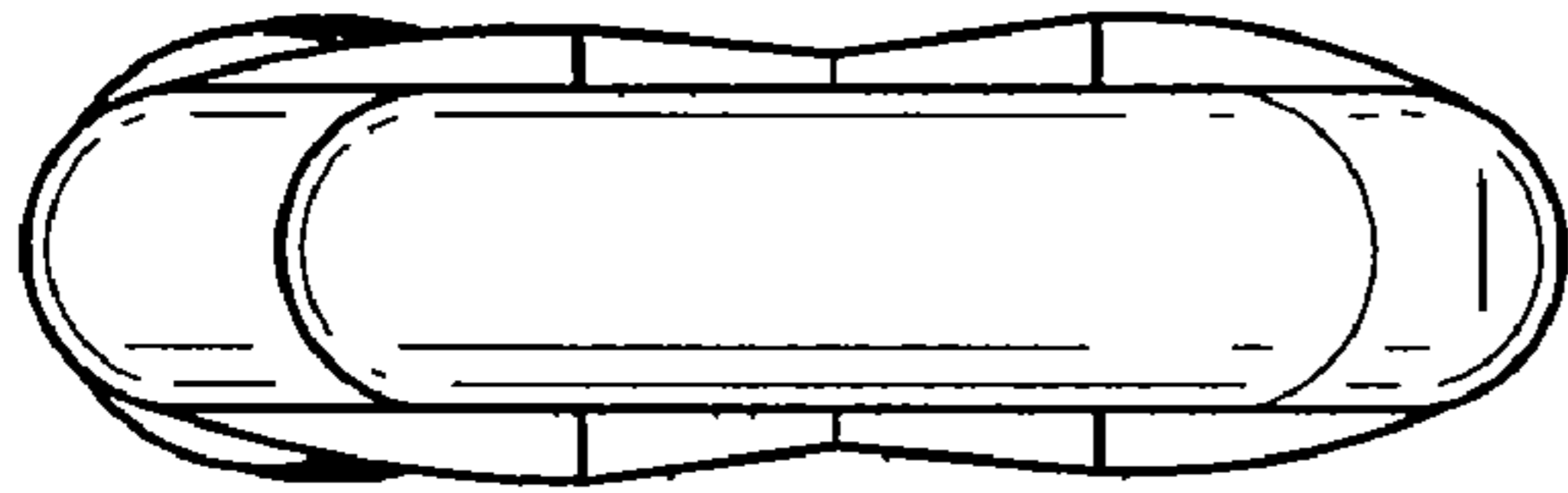

FIG. 5

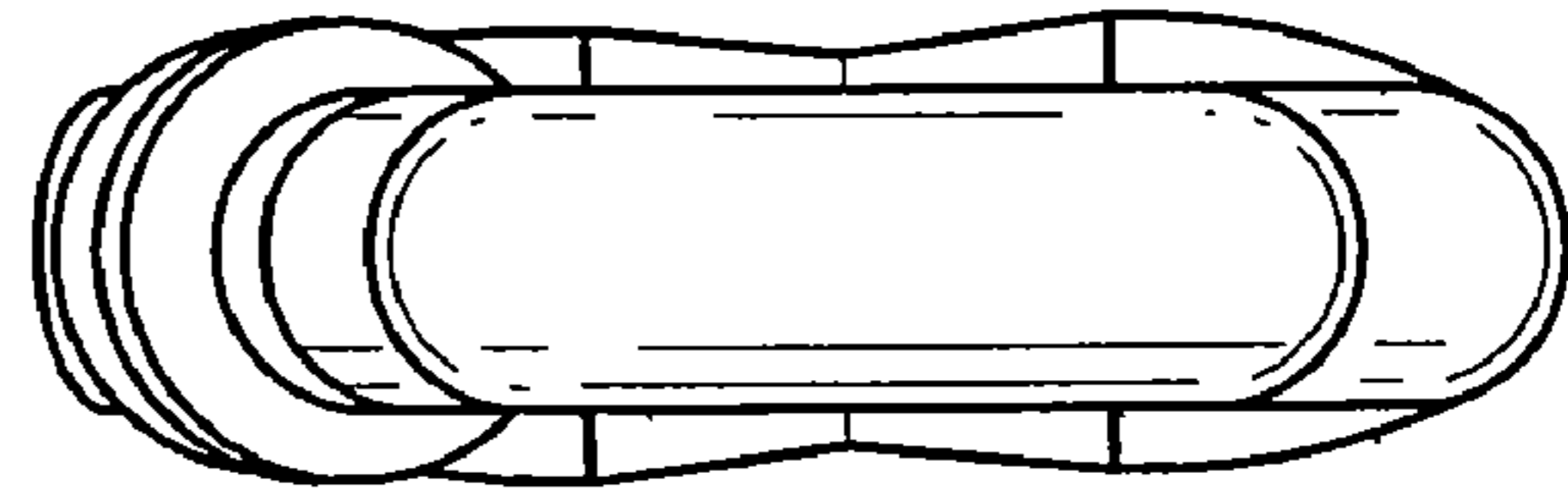

FIG. 6

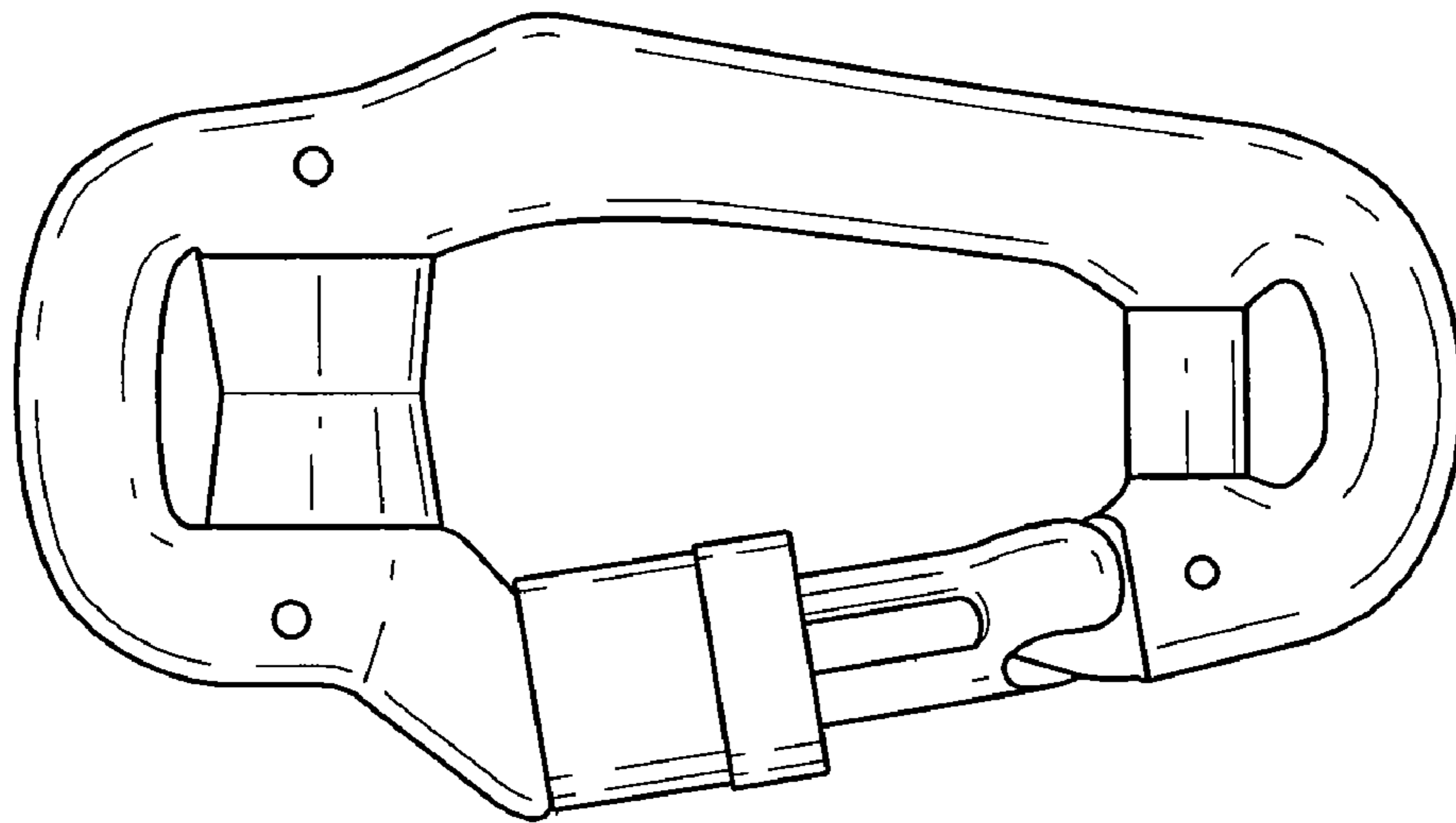

FIG. 7

