



US00D621125S

(12) **United States Design Patent**
Heintzelman

(10) **Patent No.:** **US D621,125 S**

(45) **Date of Patent:** **** Aug. 3, 2010**

(54) **DIVERSION BOOK SAFE**

(76) Inventor: **Keith A. Heintzelman**, 398 Gold Ridge Rd., Dahlonega, GA (US) 30533

(**) Term: **14 Years**

(21) Appl. No.: **29/316,313**

(22) Filed: **Sep. 14, 2009**

(51) **LOC (9) Cl.** **25-02**

(52) **U.S. Cl.** **D99/28**

(58) **Field of Classification Search** D99/28,
D99/34, 35, 37; D6/432, 438, 441, 448,
D6/457, 470, 510, 509, 559; 109/7, 35, 38-39,
109/45, 47-48, 50, 59 R, 70, 71, 77, 73; 211/4,
211/64; 312/135, 215, 297, 305, 409; 190/19;
232/4 R

See application file for complete search history.

(56) **References Cited**

U.S. PATENT DOCUMENTS

1,460,716 A *	7/1923	Greer	232/4 R
1,913,232 A *	6/1933	Dalton	232/4 R
4,467,920 A *	8/1984	Smith	206/457

* cited by examiner

Primary Examiner—Lisa P Lichtenstein

(74) *Attorney, Agent, or Firm*—Rodgers & Rodgers

(57) **CLAIM**

The ornamental design for a diversion book safe, as shown and described.

DESCRIPTION

FIG. 1 is a perspective view of a diversion book safe showing my new design;

FIG. 2 is a top plan view thereof;

FIG. 3 is a left-side elevational view thereof;

FIG. 4 is a bottom plan view thereof;

FIG. 5 is a right-side inverted elevational view thereof;

FIG. 6 is a rear inverted elevational view thereof;

FIG. 7 is a front inverted elevational view thereof;

FIG. 8 is a perspective view showing the diversion book safe in an open condition; and,

FIG. 9 is a perspective view of a second embodiment of FIG. 1, the only difference being the configuration of the locking tab, it being understood that all other surfaces are the same as those of the first embodiment.

The broken lines in the figures are for the purpose of illustrating environment and form no part of the claimed design.

1 Claim, 4 Drawing Sheets

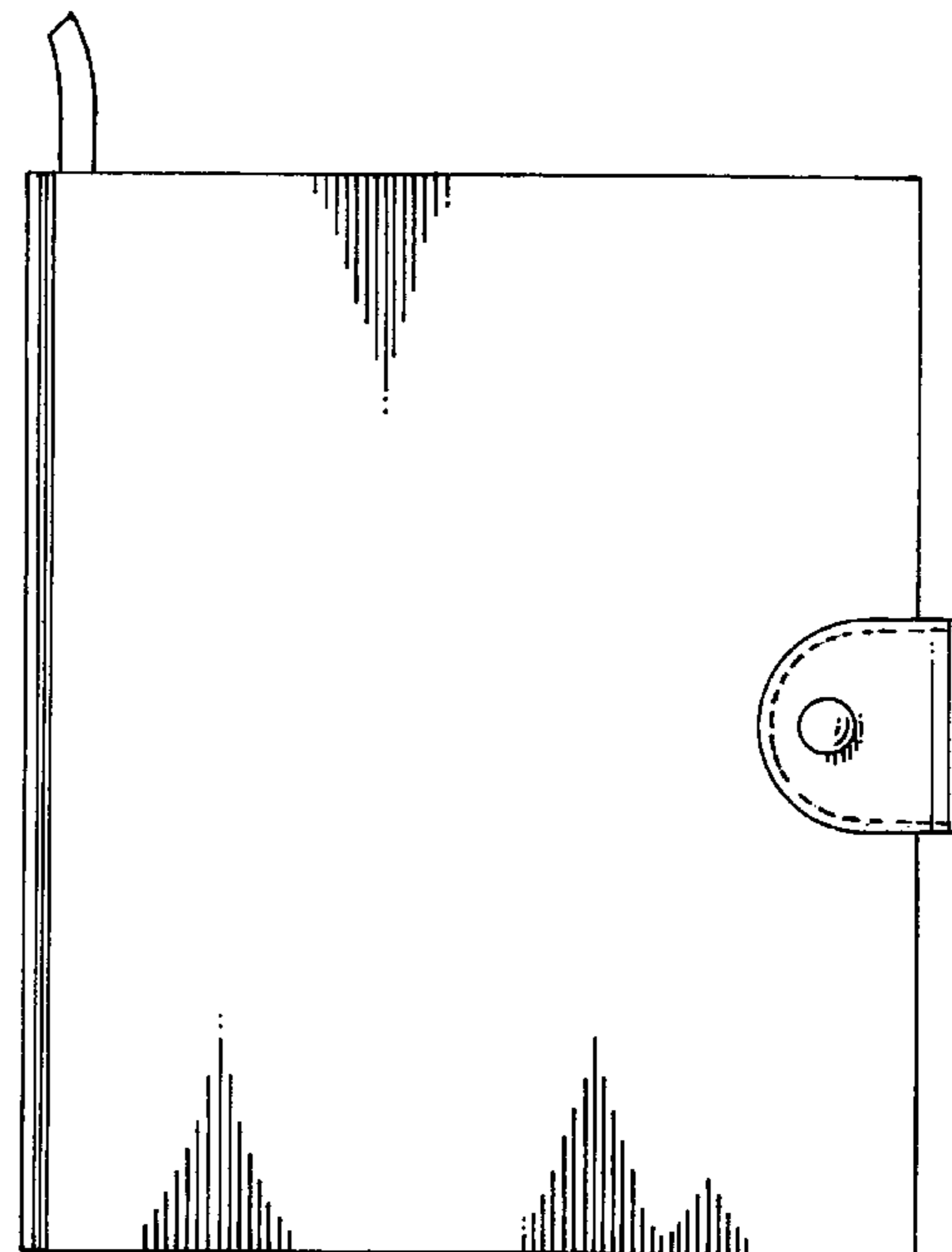
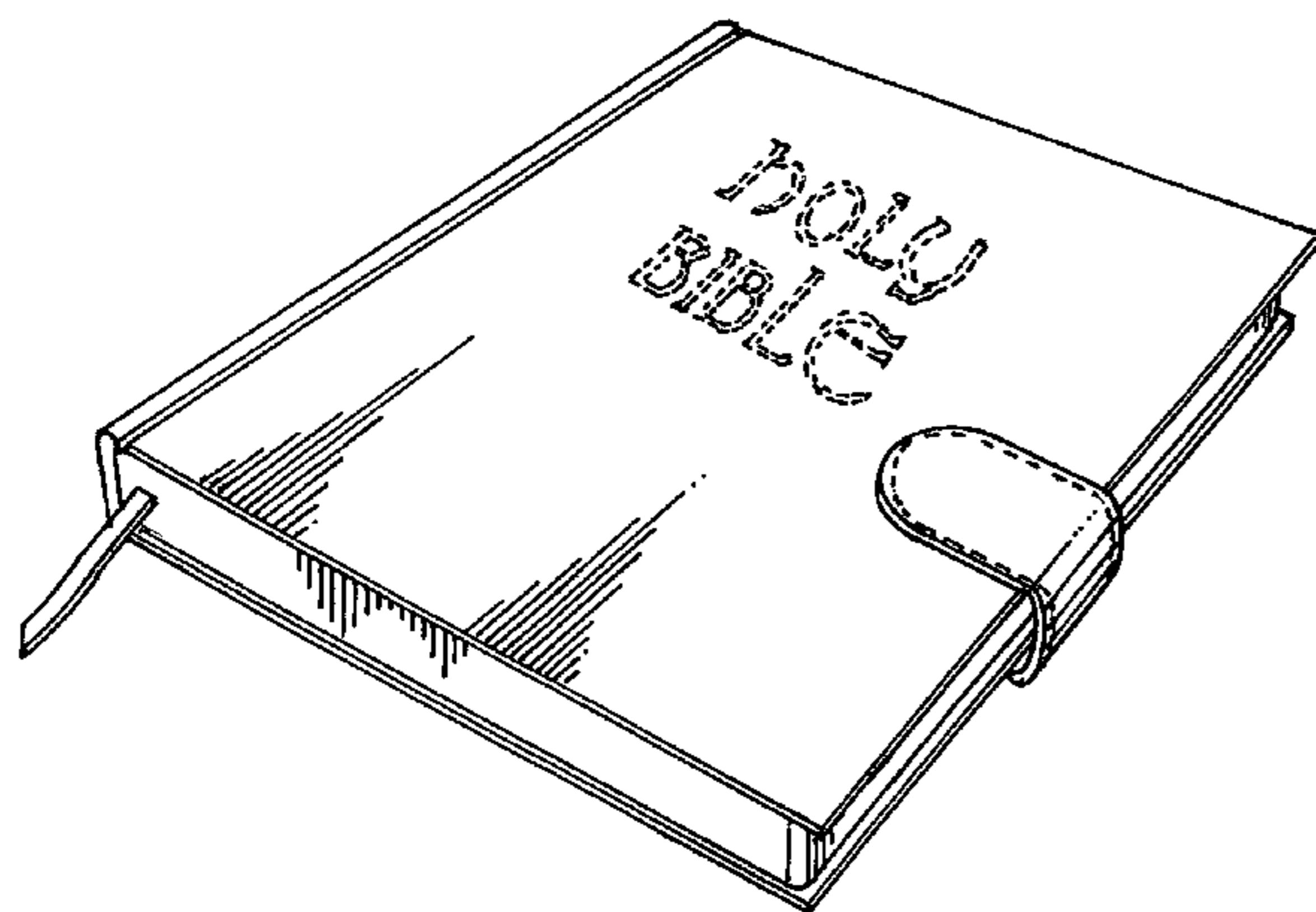

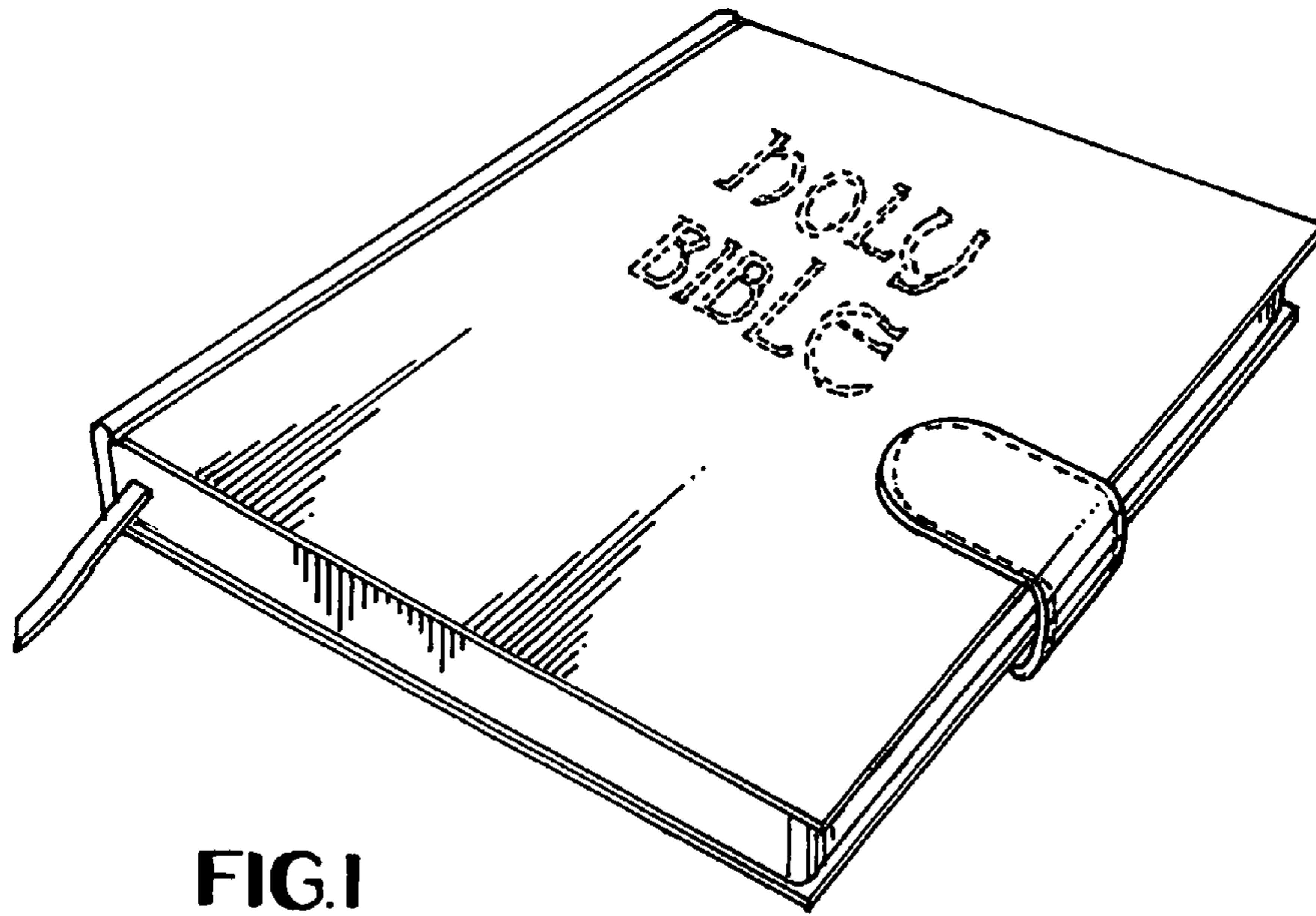

FIG. 1

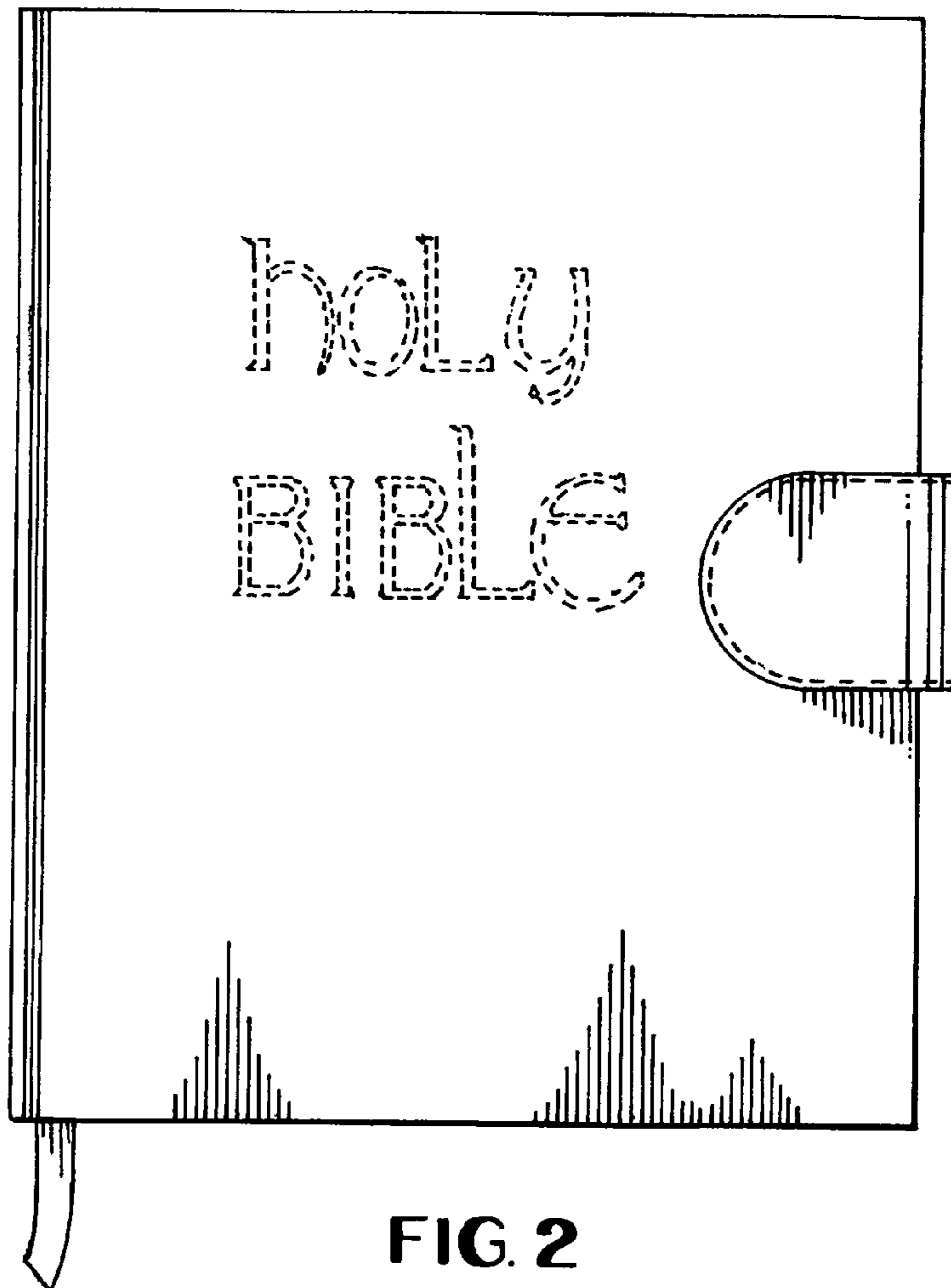

FIG. 2

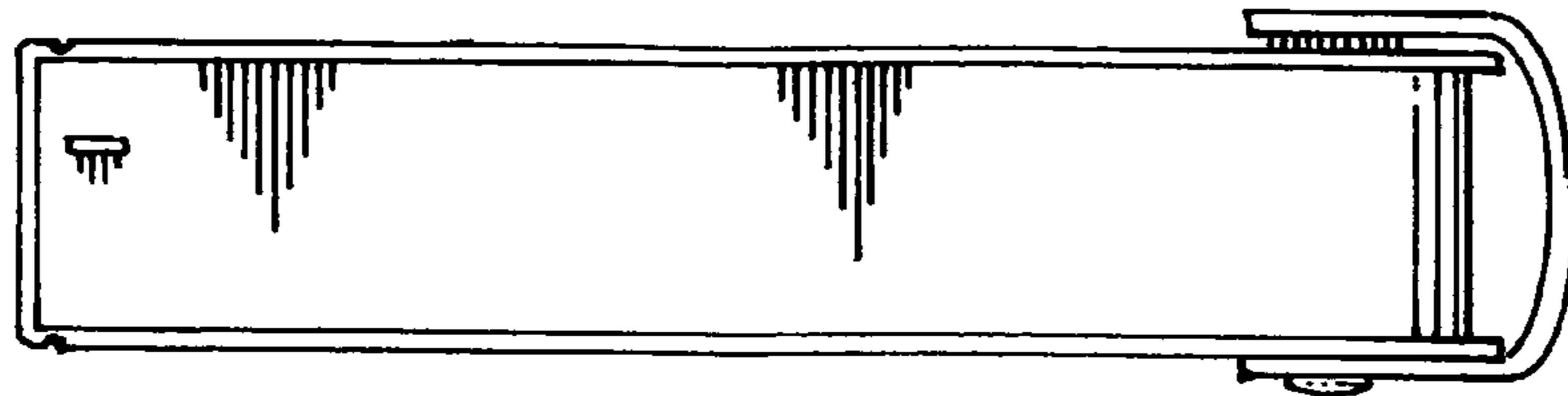

FIG. 3

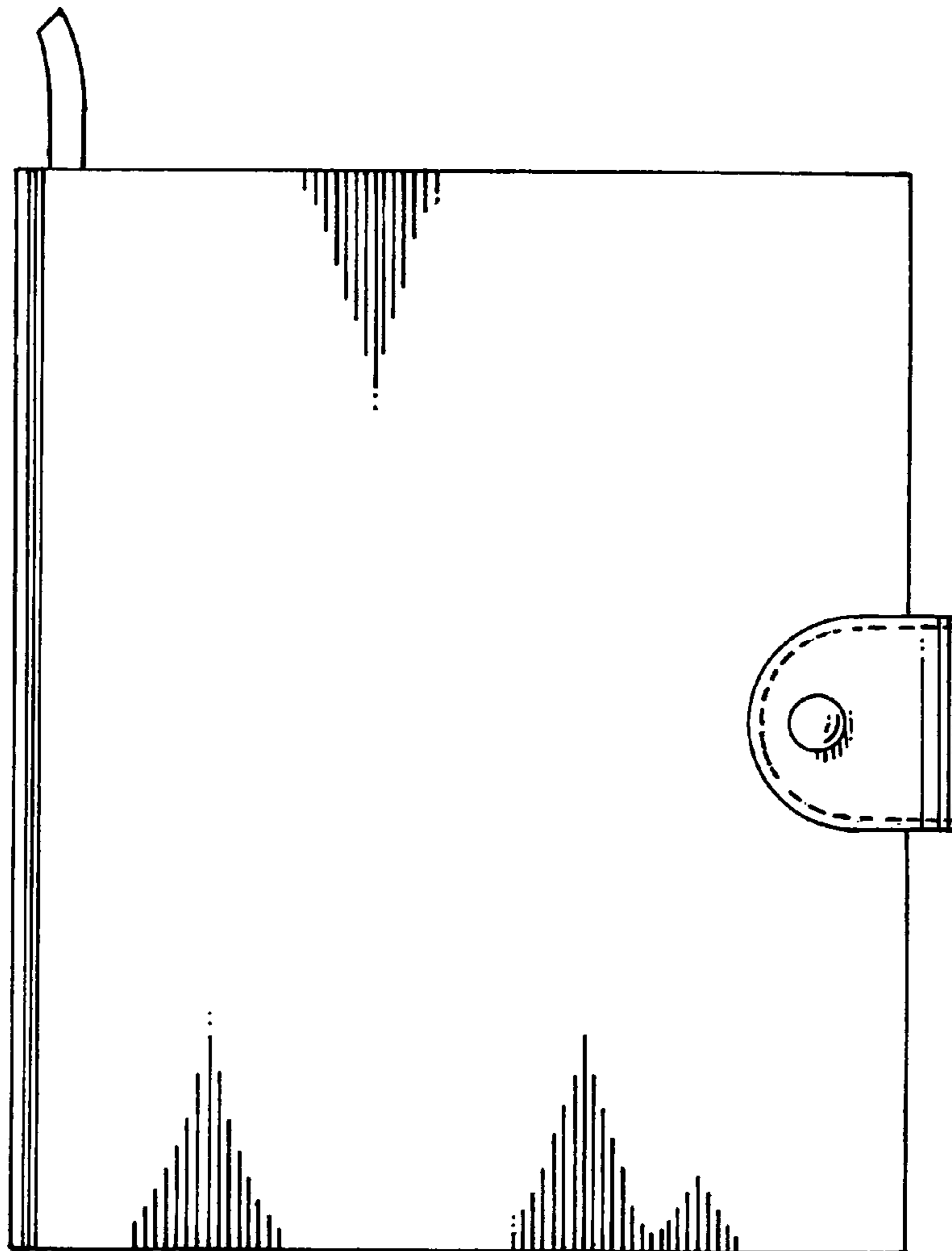

FIG. 4

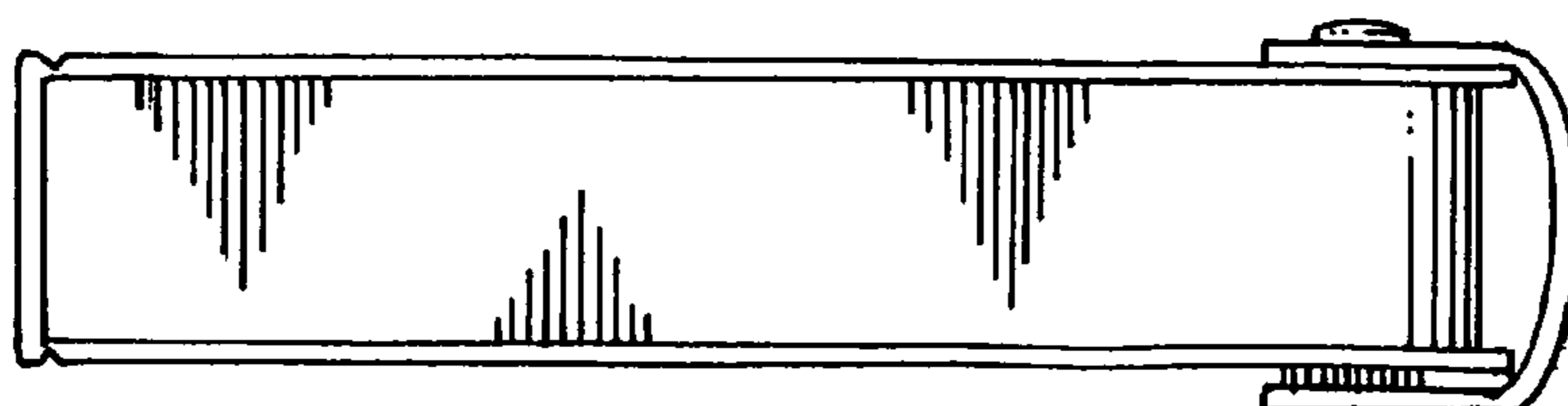

FIG. 5

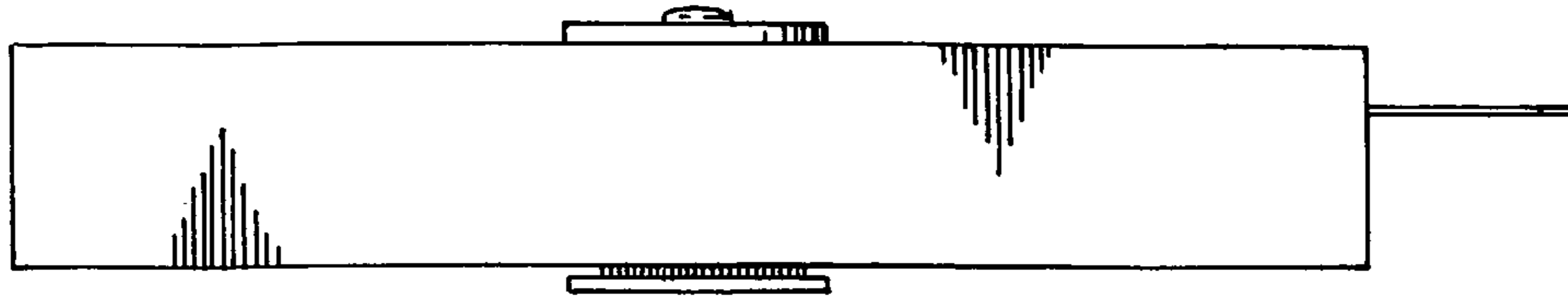

FIG. 6

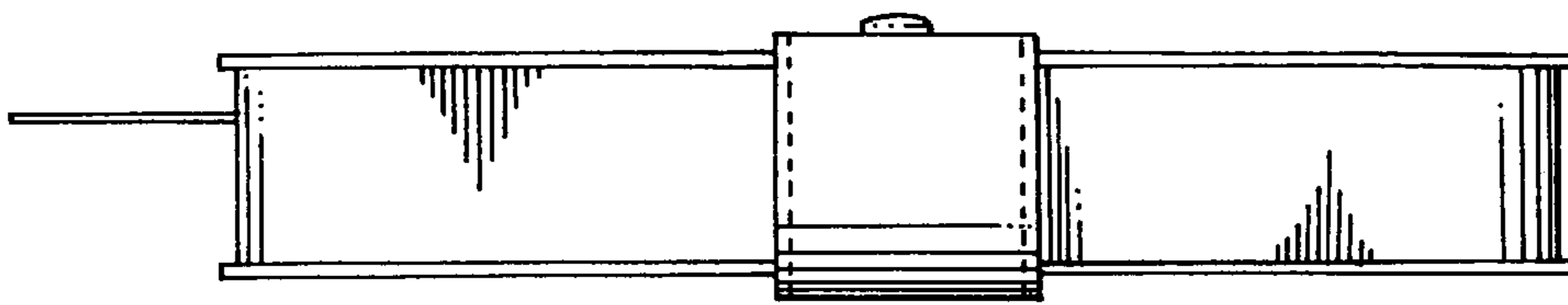

FIG. 7

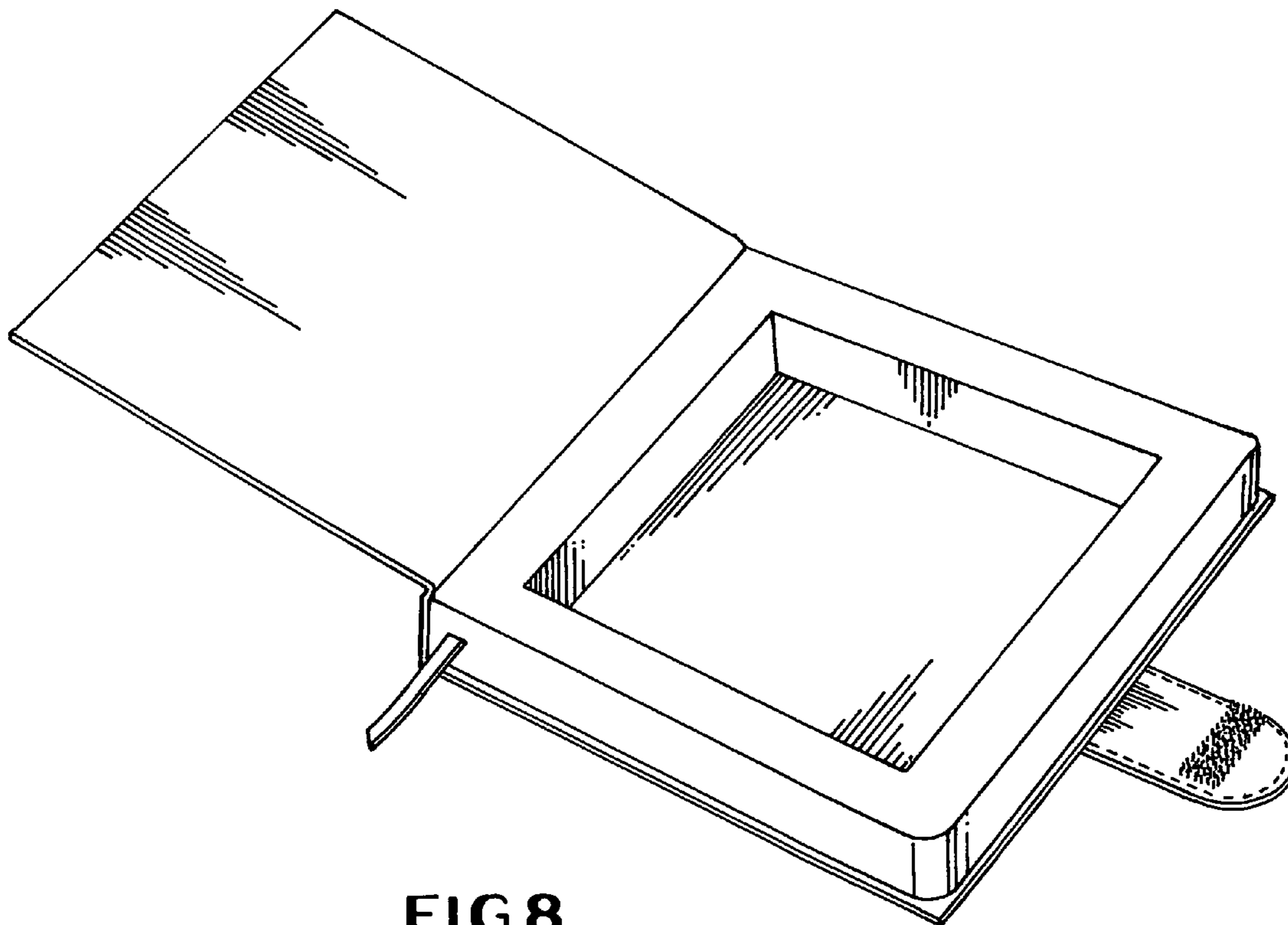

FIG. 8

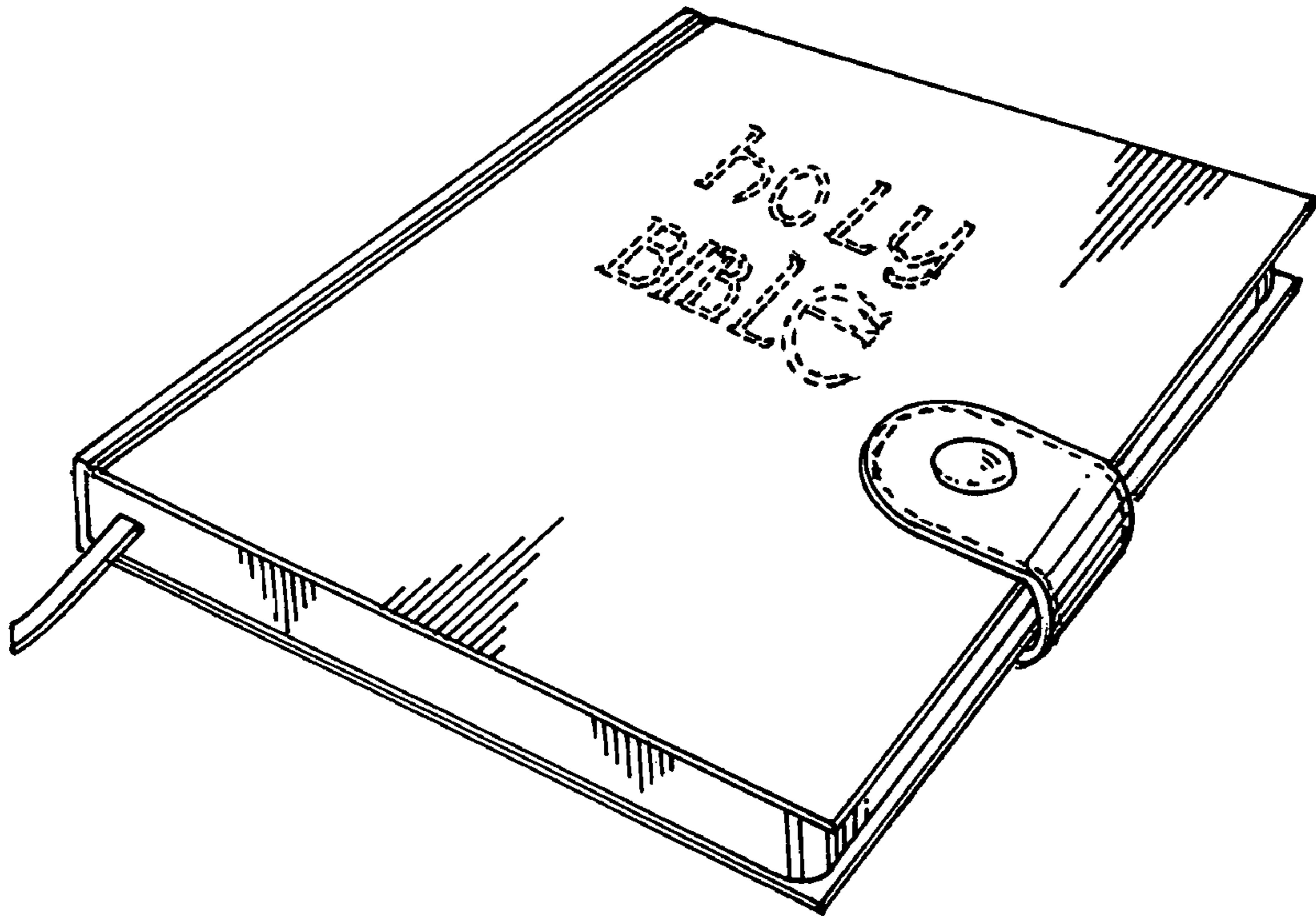

FIG. 9