



US00D621093S

(12) **United States Design Patent**
Jenkins

(10) **Patent No.:** **US D621,093 S**
(45) **Date of Patent:** **** Aug. 3, 2010**

(54) **NECK SUPPORT FOR SHAMPOO BOWLS**

6,651,269 B1 11/2003 Najjar

(76) Inventor: **Brenda S. Jenkins**, 1214 Berkley Hills
Pass, Evans, GA (US) 30809

* cited by examiner

Primary Examiner—Janice E Seeger
Assistant Examiner—Zenia I Bennett
(74) *Attorney, Agent, or Firm*—Richard C. Litman

(**) Term: **14 Years**

(21) Appl. No.: **29/311,851**

(57) **CLAIM**

(22) Filed: **Jul. 14, 2009**

The ornamental design for a neck support for shampoo bowls,
as shown and described.

(51) **LOC (9) Cl.** **28-03**

(52) **U.S. Cl.** **D28/20**

(58) **Field of Classification Search** D28/9,
D28/10, 20; D23/289, 308; D6/596, 601;
4/515, 516, 519, 523

DESCRIPTION

See application file for complete search history.

FIG. 1 is a perspective view of a neck support for shampoo
bowls showing my new design;

(56) **References Cited**

U.S. PATENT DOCUMENTS

FIG. 2 is a front elevational view thereof;

FIG. 3 is a rear elevational view thereof;

FIG. 4 is a right side elevational view with the left side being
a mirror image thereof;

| | | | | | | |
|-----------|---|---|---------|-----------|-------|--------|
| D102,809 | S | * | 1/1937 | Wutzler | | D28/20 |
| 2,172,589 | A | * | 9/1939 | Middleton | | 4/516 |
| D173,813 | S | * | 1/1955 | Mlitana | | D28/20 |
| D227,847 | S | * | 7/1973 | Molle | | D28/20 |
| D228,695 | S | * | 10/1973 | Vora | | D28/20 |
| D232,269 | S | * | 7/1974 | Cates | | D28/20 |
| D241,581 | S | * | 9/1976 | Gonzales | | D28/20 |
| D267,669 | S | * | 1/1983 | Pounds | | D28/20 |
| D272,860 | S | * | 2/1984 | Swatzell | | D28/20 |
| D273,142 | S | * | 3/1984 | Briggs | | D28/20 |
| 4,649,580 | A | | 3/1987 | Bastien | | |
| D335,419 | S | * | 5/1993 | Michalek | | D6/601 |
| D376,034 | S | * | 11/1996 | Willis | | D28/20 |
| 5,924,145 | A | | 7/1999 | Najar | | |

FIG. 5 is a top view thereof;

FIG. 6 is a bottom view thereof; and,

FIG. 7 is an environmental perspective view thereof.

The broken line showing of the chair and the sink in FIG. 7 is
for illustrative purposes only and forms no part of the claimed
design.

The broken lines located in the center of the neck support
shown in FIGS. 1-3 and 5-6 of the drawings represent stitching.

1 Claim, 7 Drawing Sheets

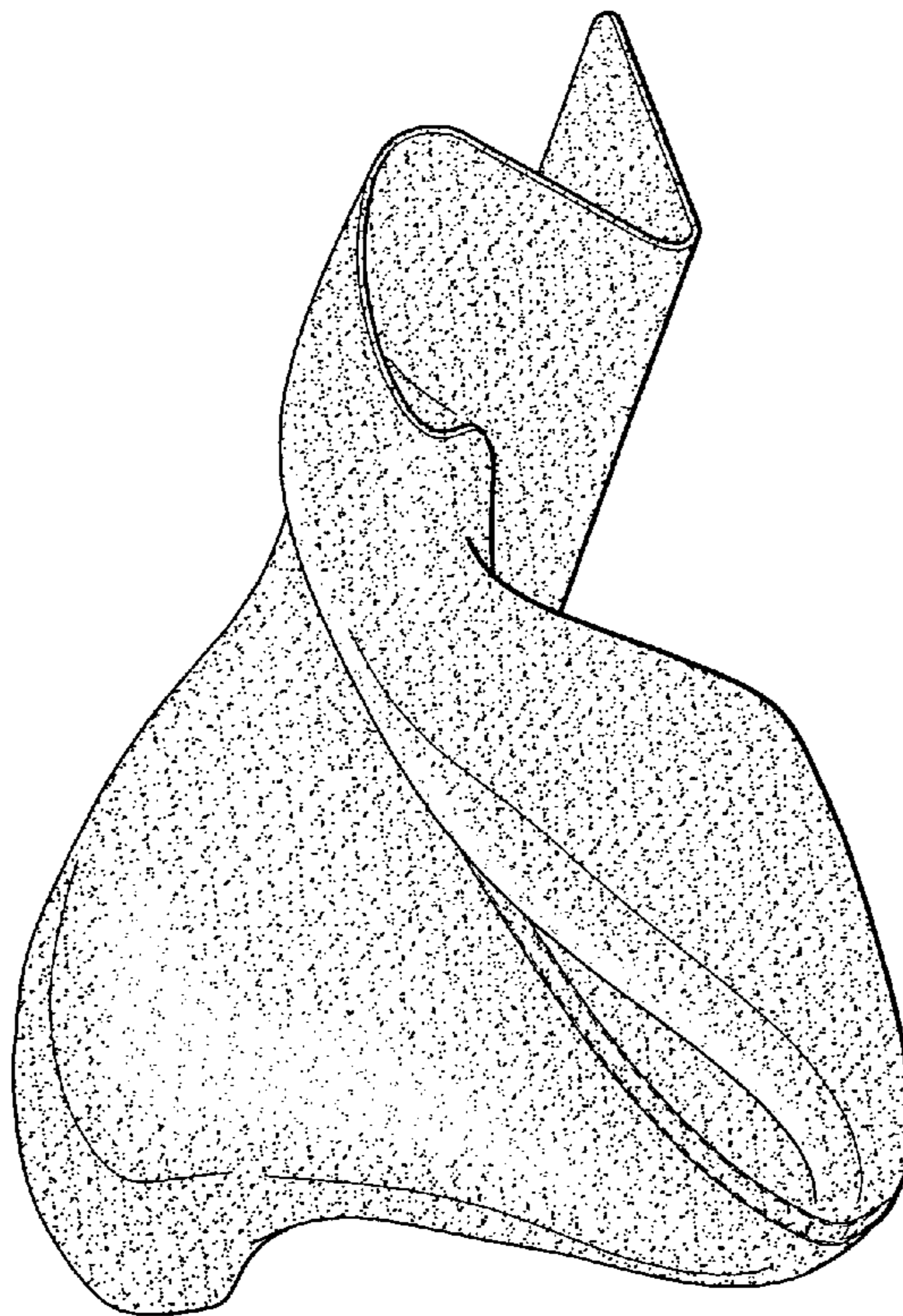

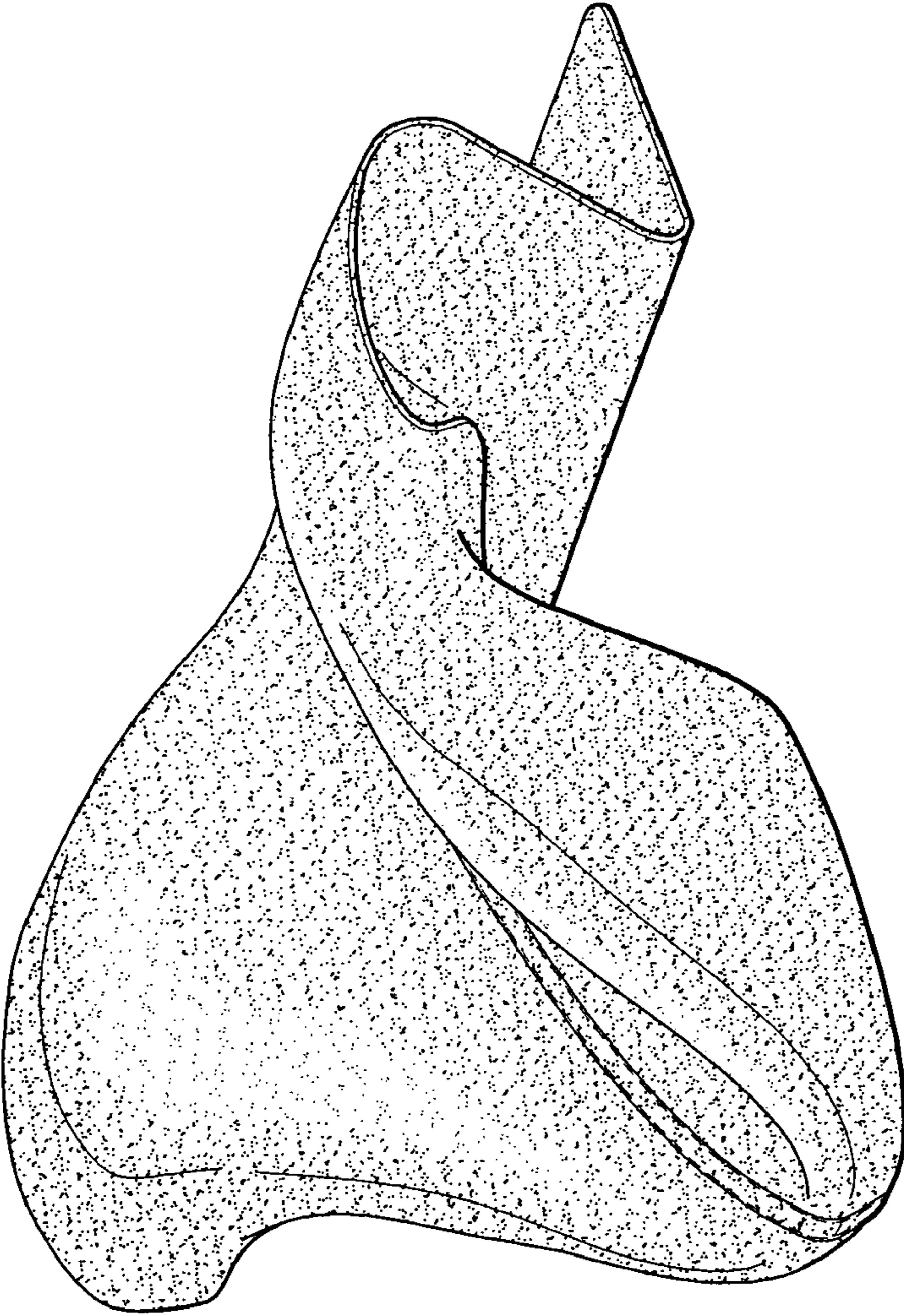

FIG. 1

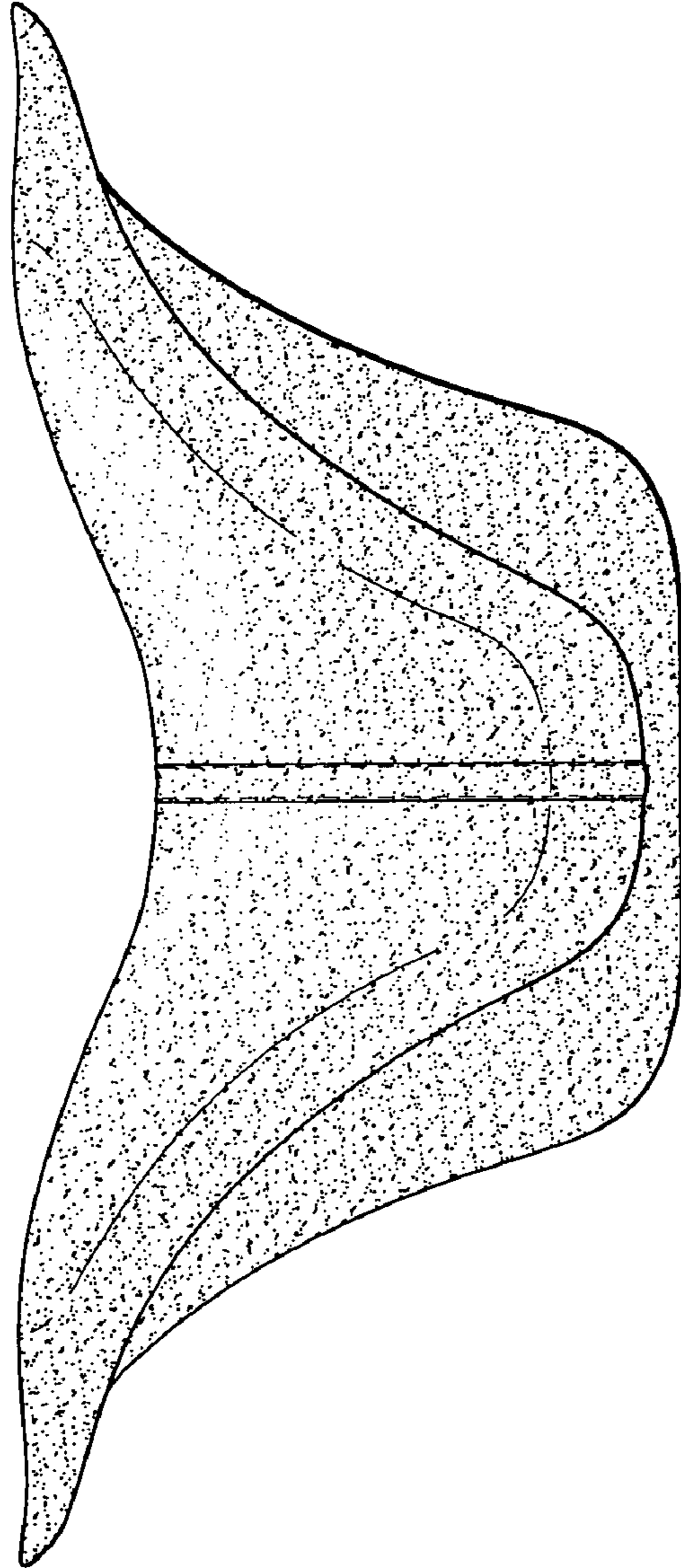

FIG. 2

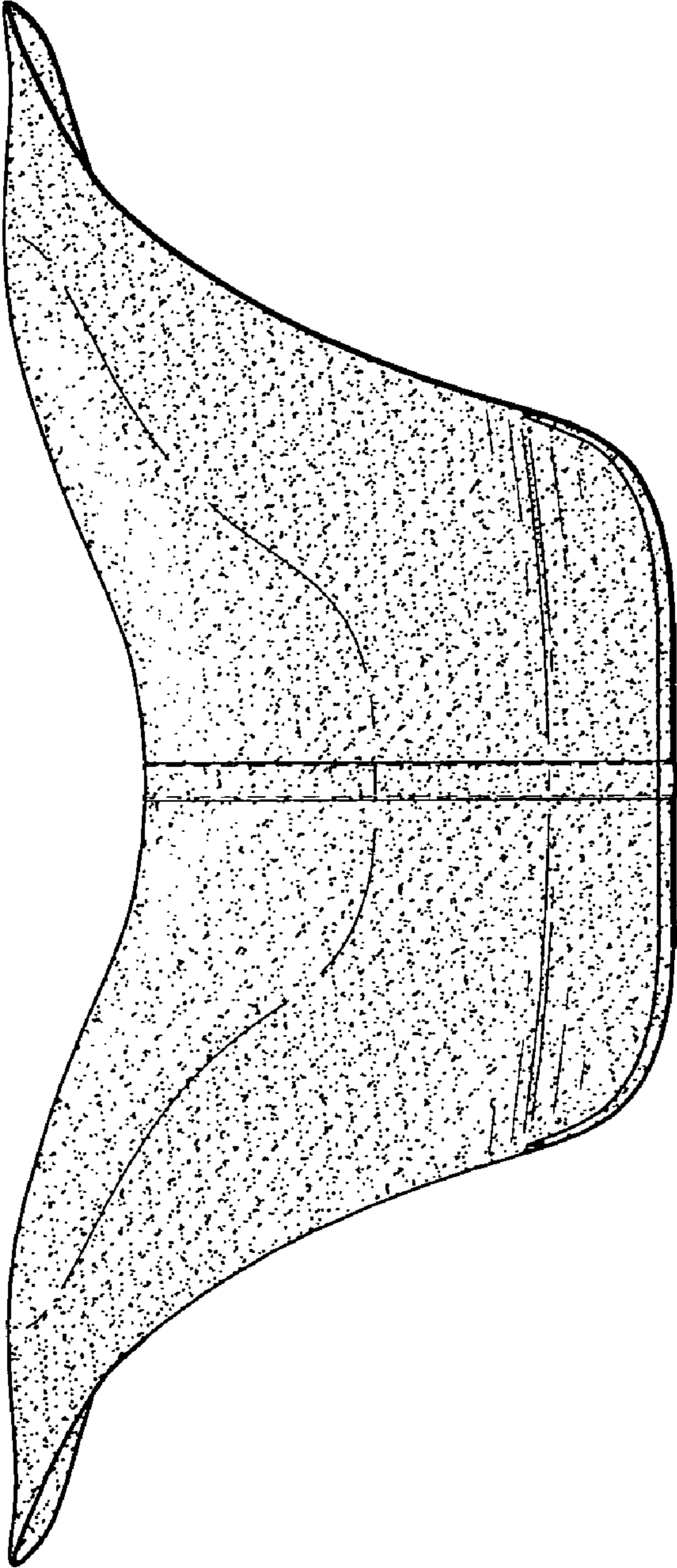

FIG. 3

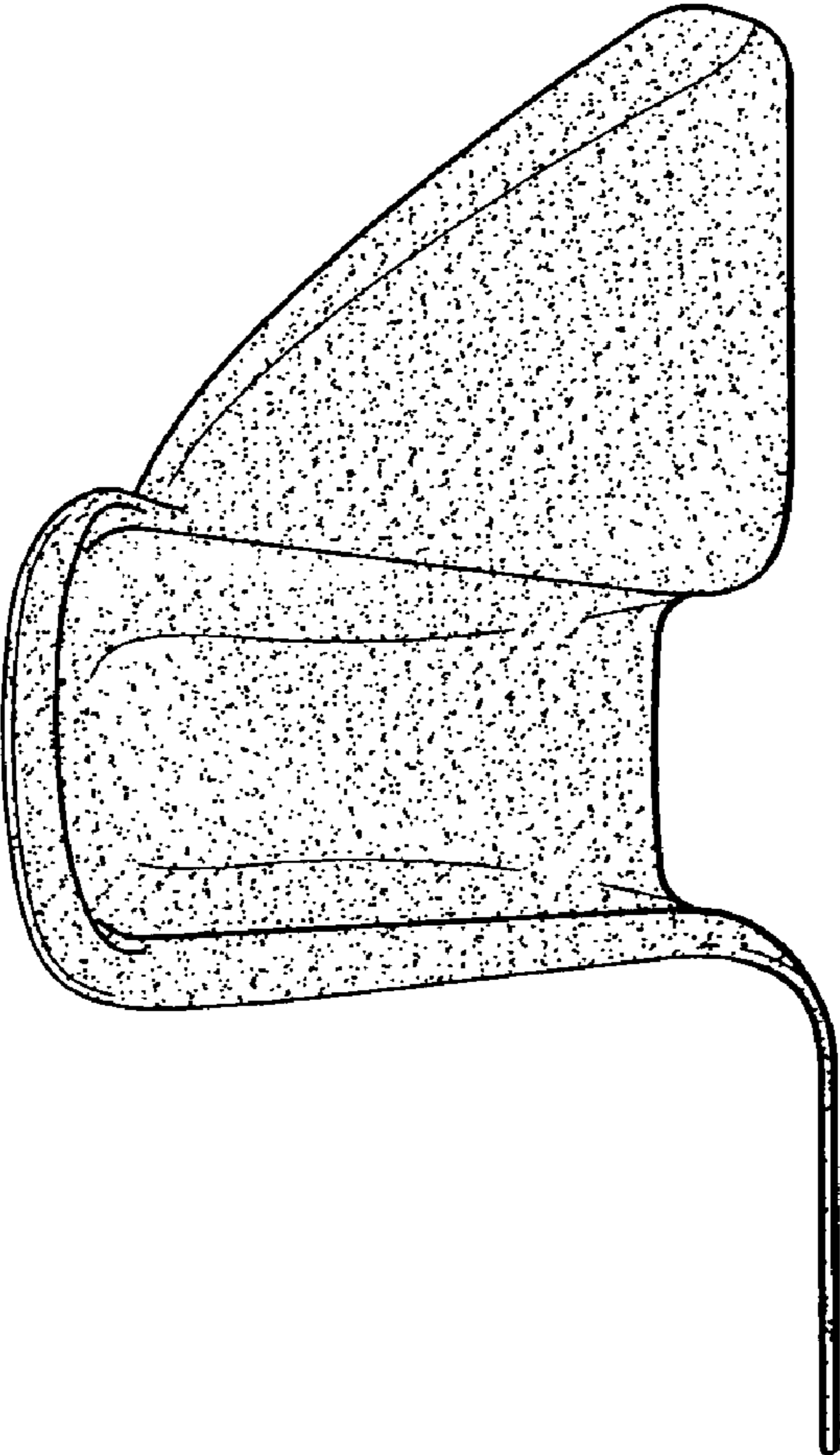

FIG. 4

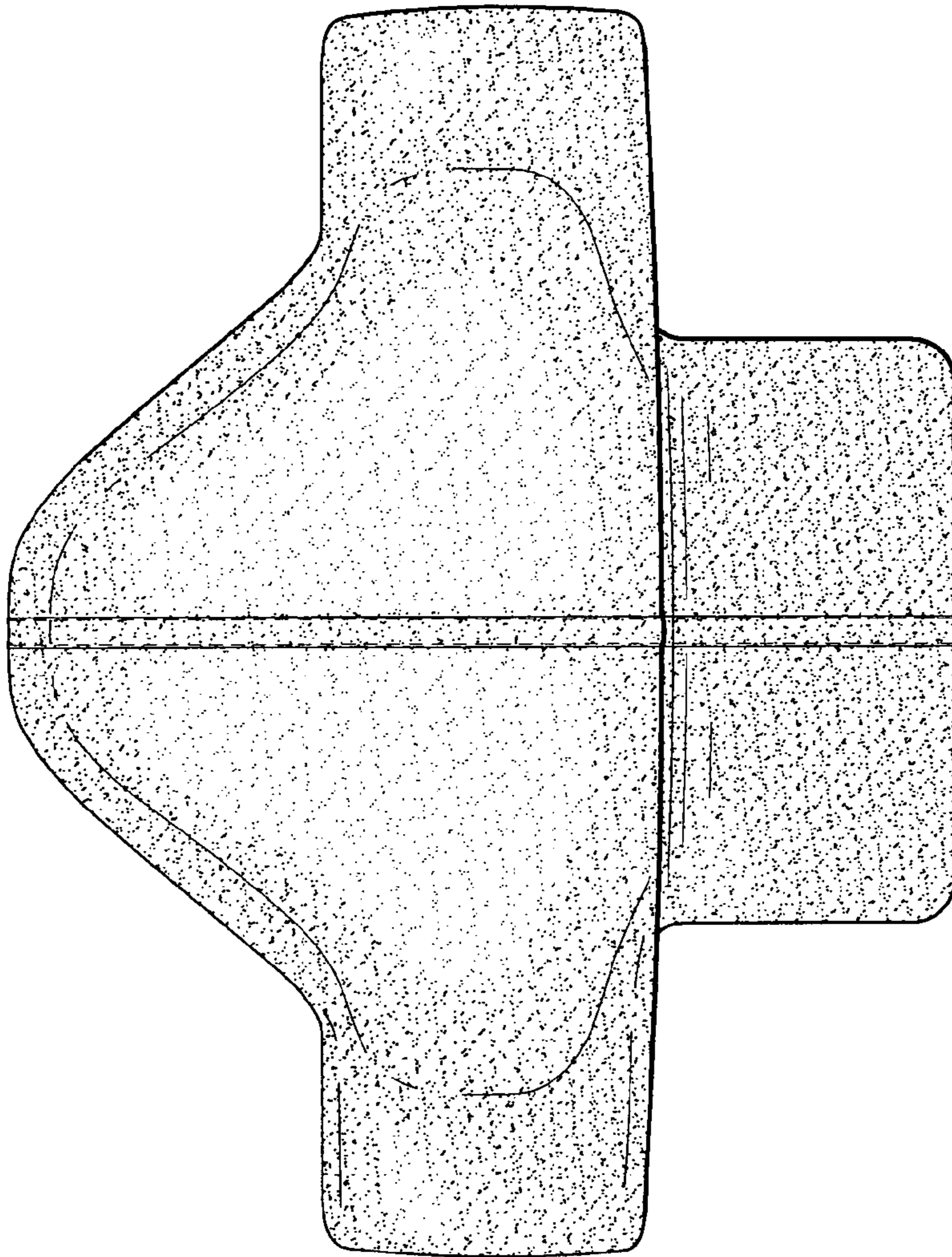

FIG. 5

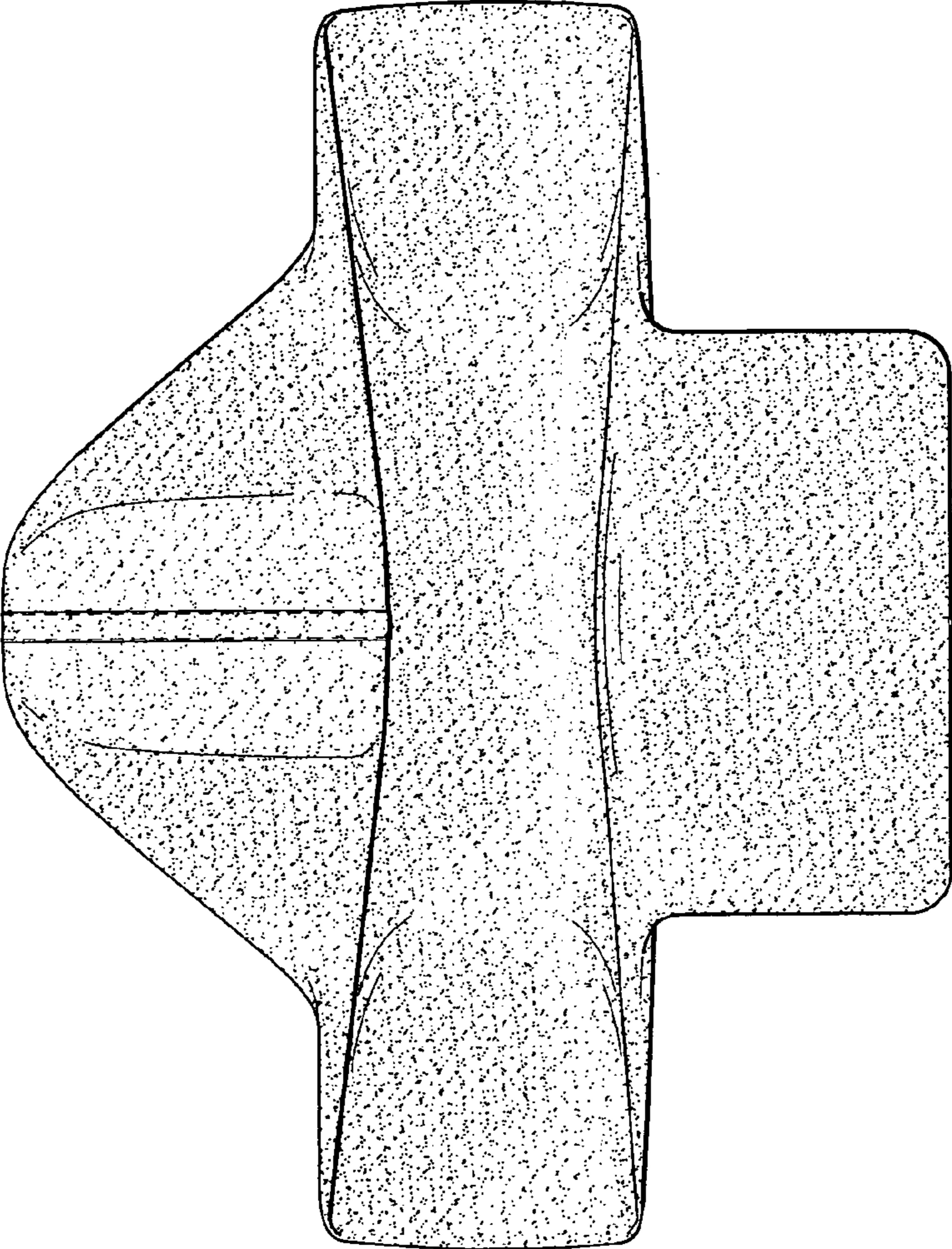

FIG. 6

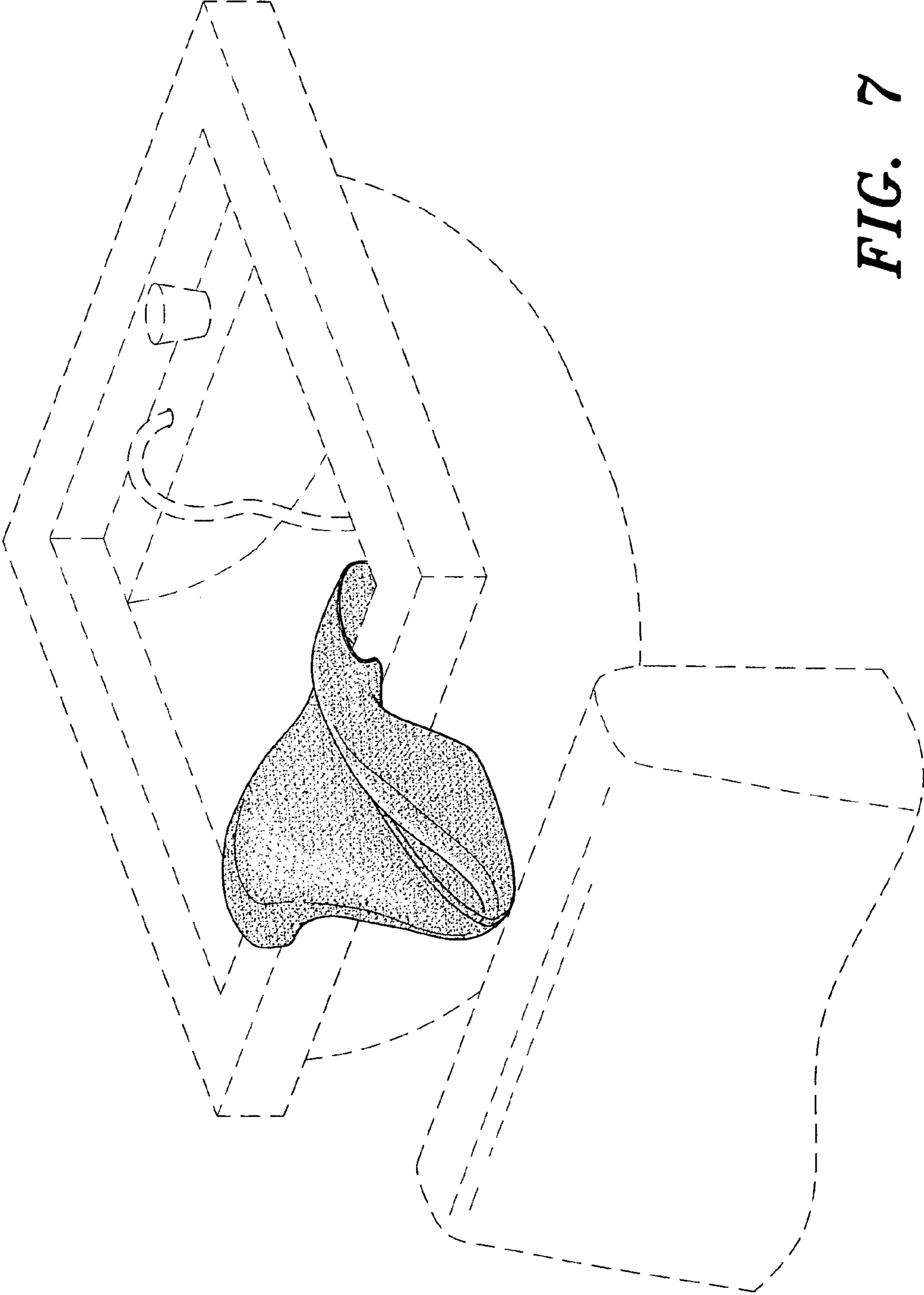

FIG. 7