



US00D621075S

(12) **United States Design Patent**
Haeussler

(10) **Patent No.:** **US D621,075 S**

(45) **Date of Patent:** **** Aug. 3, 2010**

(54) **ATTACHMENT PORTION OF A CLADDING TILE**

5,743,059 A * 4/1998 Fifield 52/519

(75) Inventor: **Wolfgang Haeussler**,
Orsingen-Nenzingen (DE)

* cited by examiner

Primary Examiner—Doris Clark

(74) *Attorney, Agent, or Firm*—Kreigsmann & Kreigsmann

(73) Assignee: **Creaton AG**, Wertingen (DE)

(57) **CLAIM**

(**) Term: **14 Years**

The ornamental design for an attachment portion of a cladding tile, as shown and described.

(21) Appl. No.: **29/315,910**

(22) Filed: **Aug. 4, 2009**

DESCRIPTION

(30) **Foreign Application Priority Data**

Feb. 4, 2009	(EP)	001082184-0001
Feb. 4, 2009	(EP)	001082184-0002
Feb. 4, 2009	(EP)	001082184-0003

FIG. 1 is a front perspective view of one embodiment of an attachment portion of a cladding tile showing my new design;

FIG. 2 is a rear perspective view of the attachment portion of a cladding tile shown in FIG. 1;

FIG. 3 is a front view of the attachment portion of a cladding tile shown in FIG. 1;

FIG. 4 is a rear view of the attachment portion of a cladding tile shown in FIG. 1;

FIG. 5 is a top view of the attachment portion of a cladding tile shown in FIG. 1;

FIG. 6 is a bottom view of the attachment portion of a cladding tile shown in FIG. 1;

FIG. 7 is a left side view of the attachment portion of a cladding tile shown in FIG. 1; and,

FIG. 8 is a right side view of the attachment portion of a cladding tile shown in FIG. 1.

(51) **LOC (9) Cl.** **25-01**

(52) **U.S. Cl.** **D25/140**

(58) **Field of Classification Search** D25/139,
D25/140, 138; 52/386, 387; D8/349

See application file for complete search history.

The broken lines are for illustrative purposes only and form no part of the claimed design.

(56) **References Cited**

U.S. PATENT DOCUMENTS

4,803,821	A *	2/1989	Funaki	52/387
4,890,433	A *	1/1990	Funaki	52/386
D367,419	S *	2/1996	Murasaki	D8/382
D370,539	S *	6/1996	Treat	D25/140
5,566,517	A *	10/1996	Ishii et al.	52/387

1 Claim, 3 Drawing Sheets

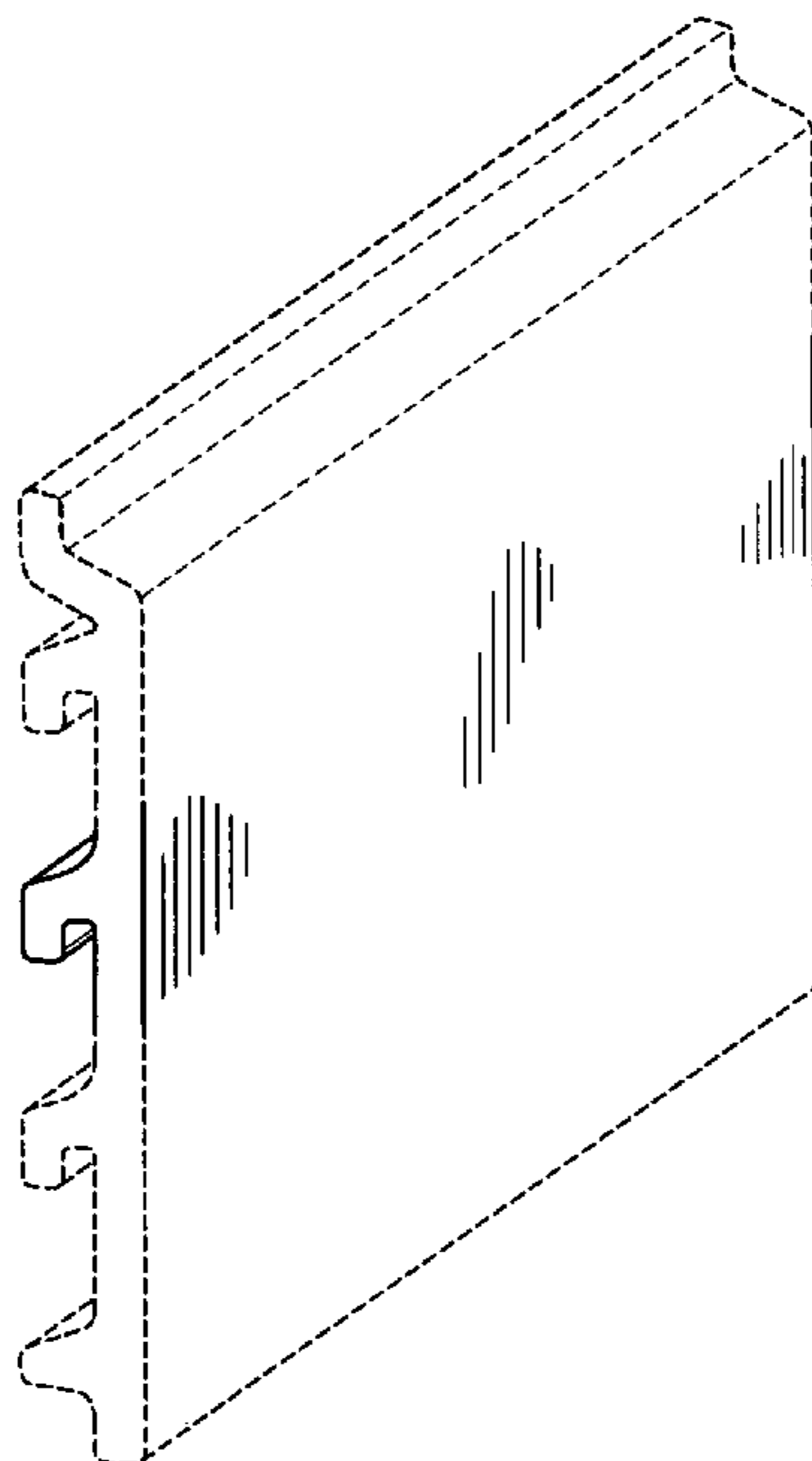

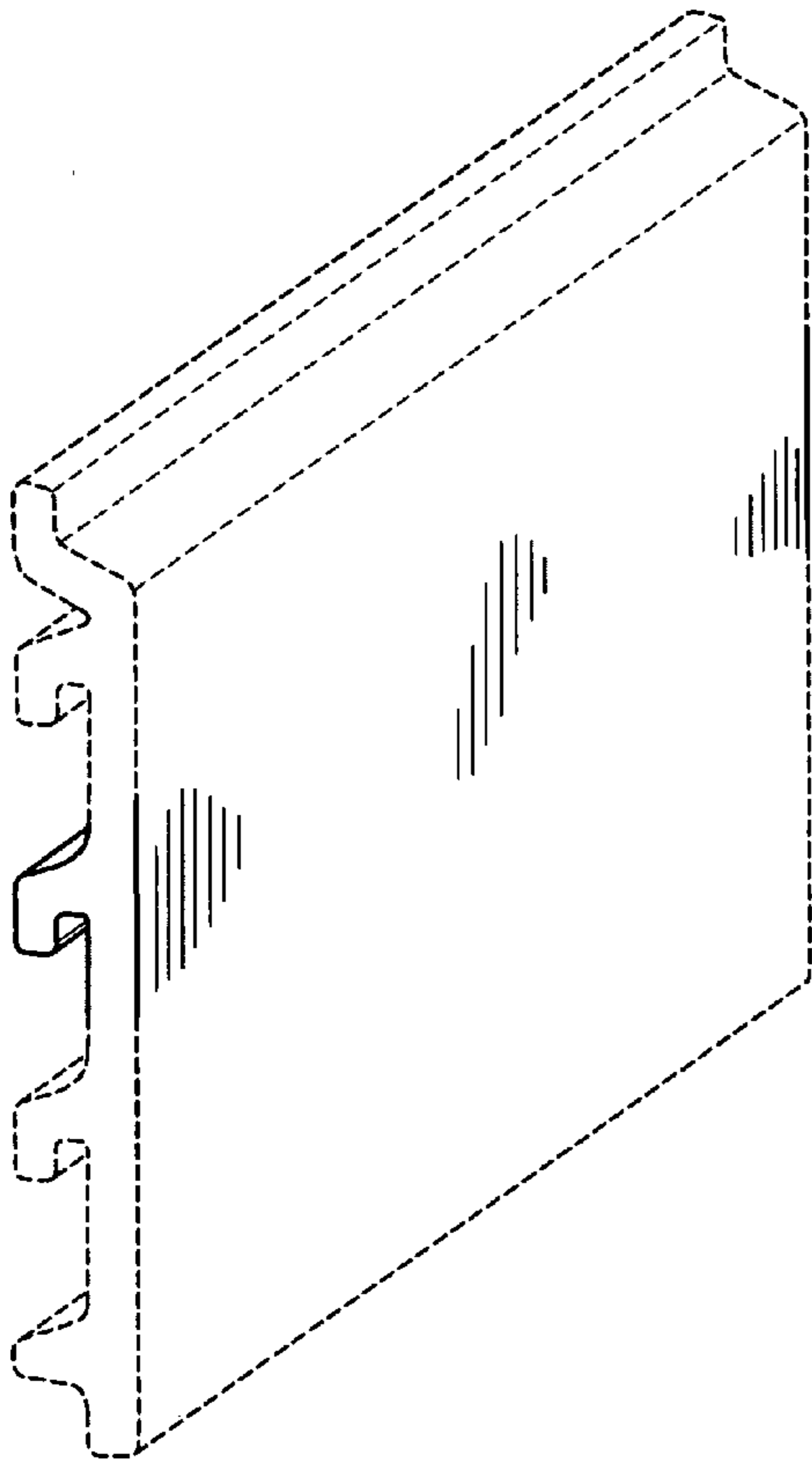

FIG. 1

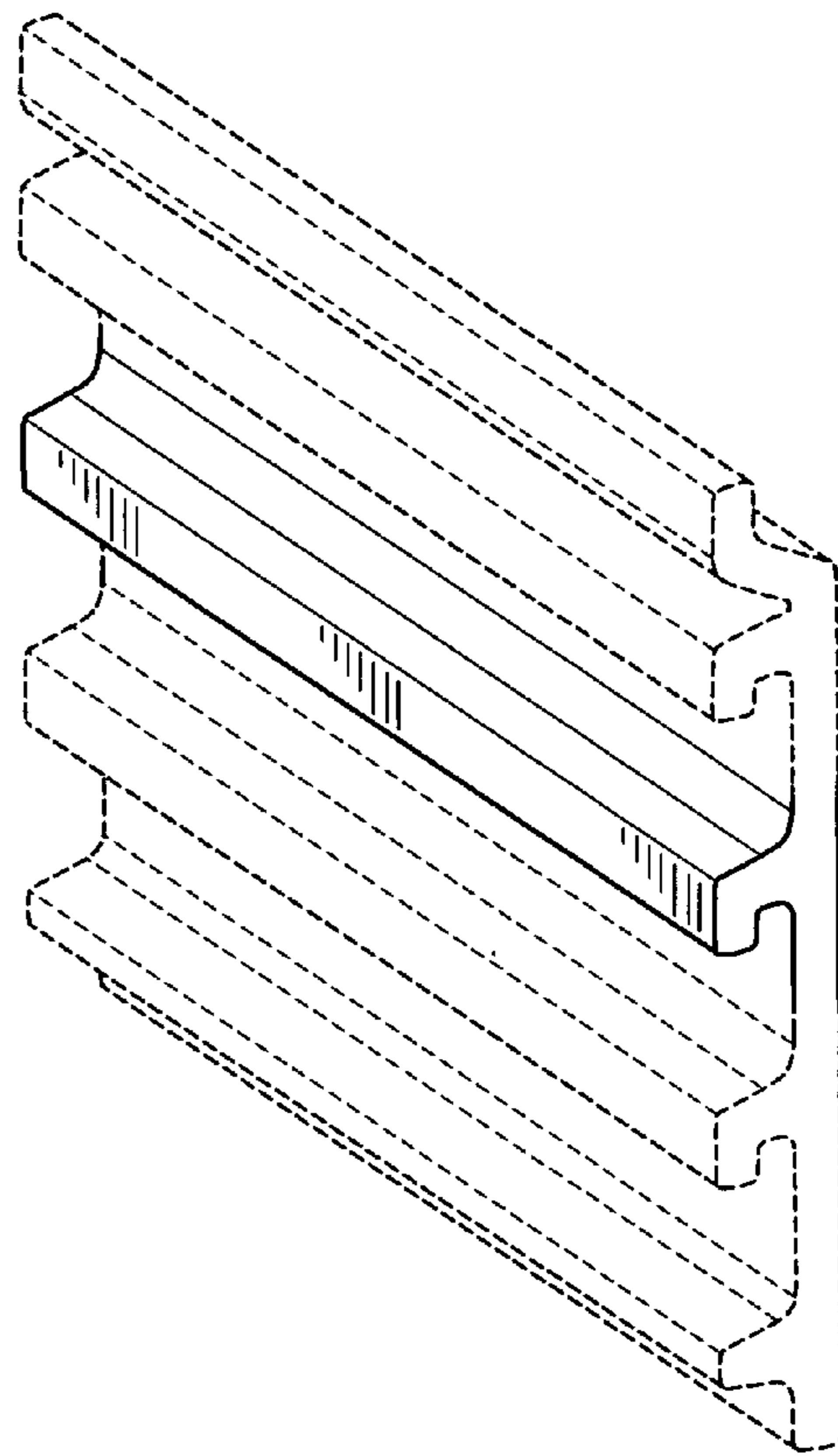

FIG. 2

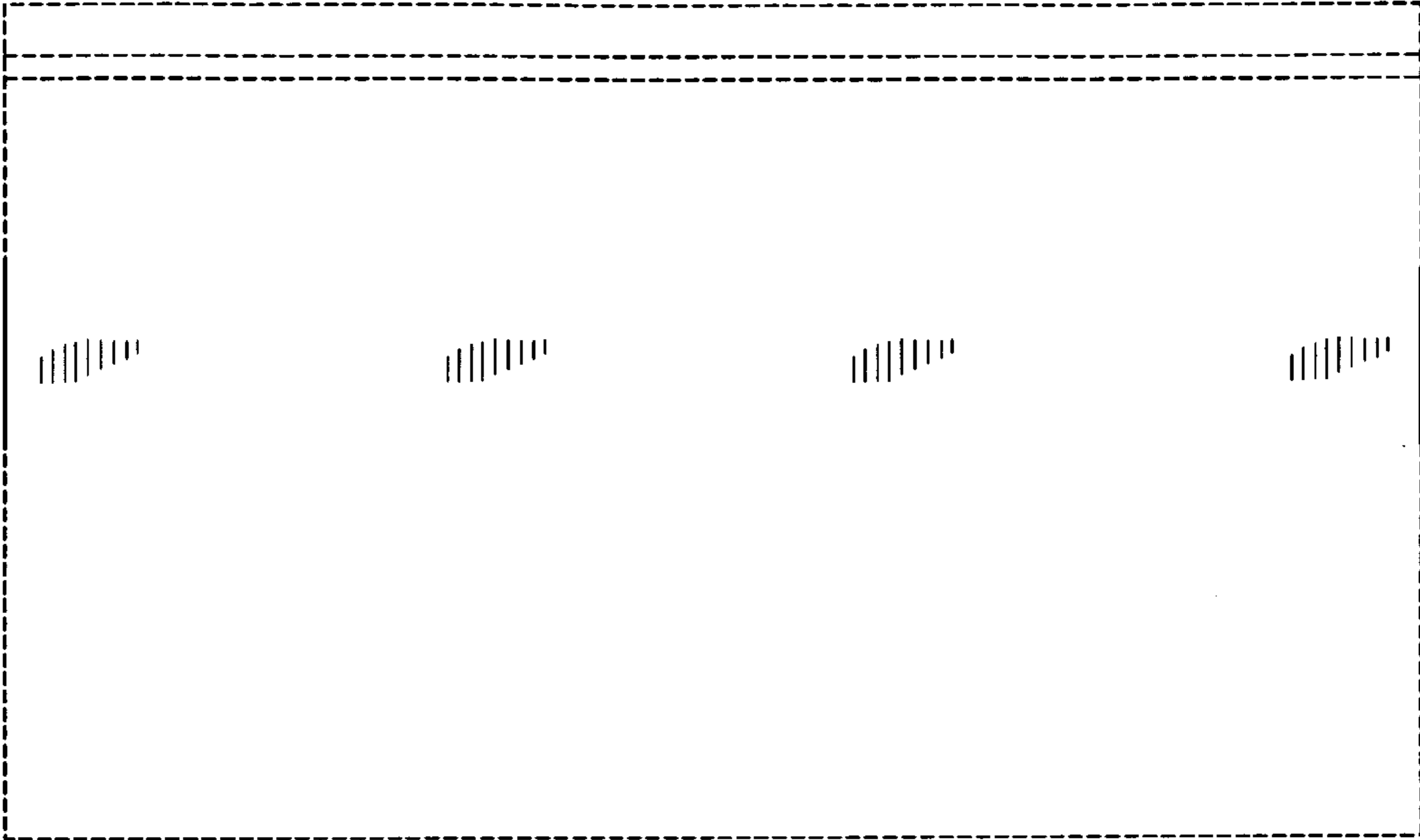

FIG. 3

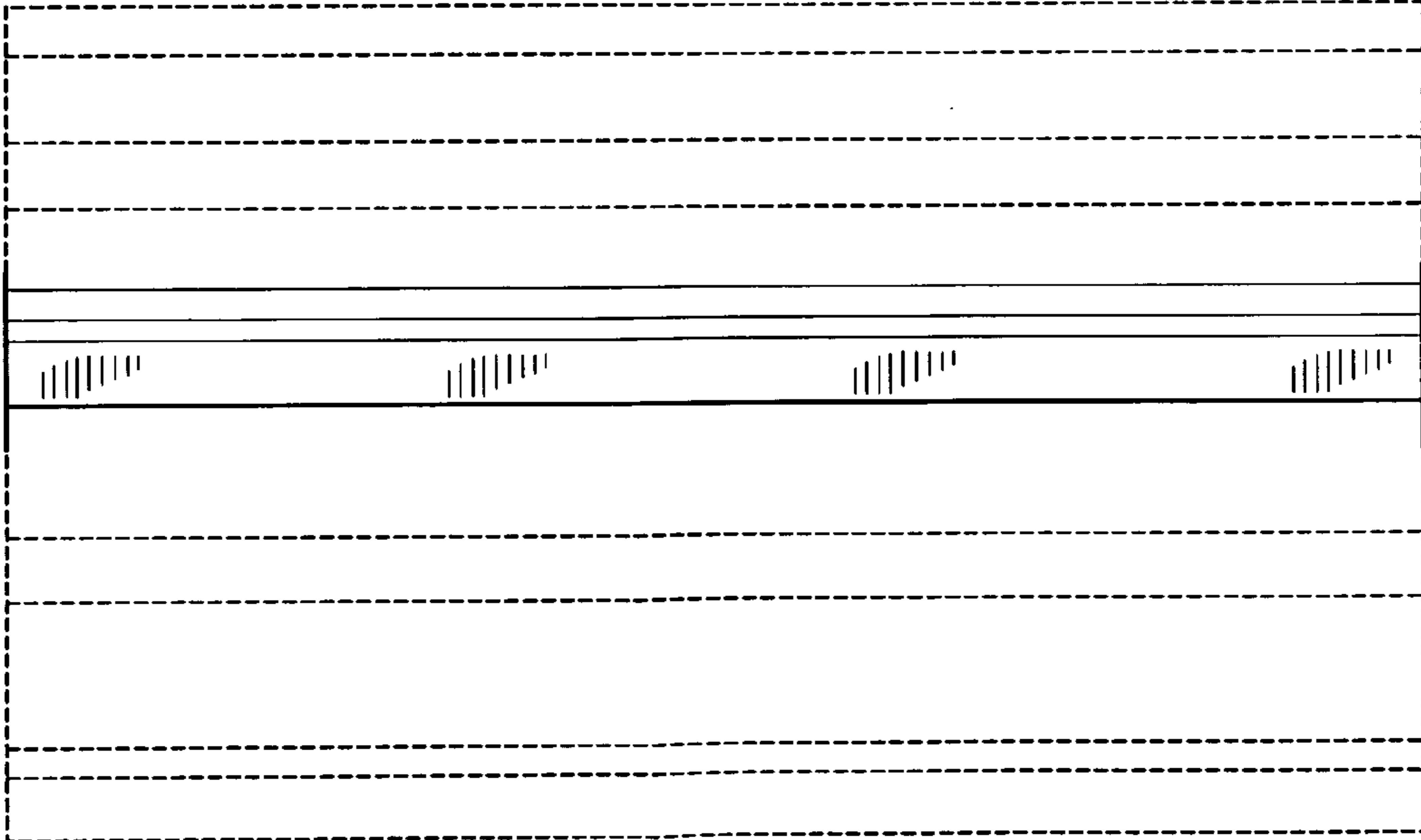

FIG. 4

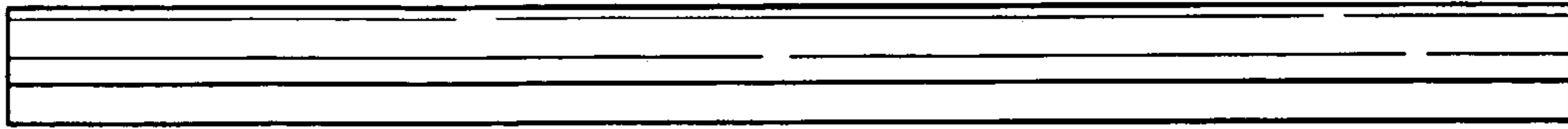

FIG. 5

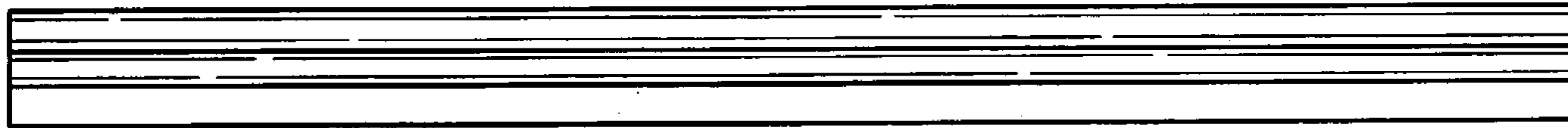

FIG. 6



FIG. 7

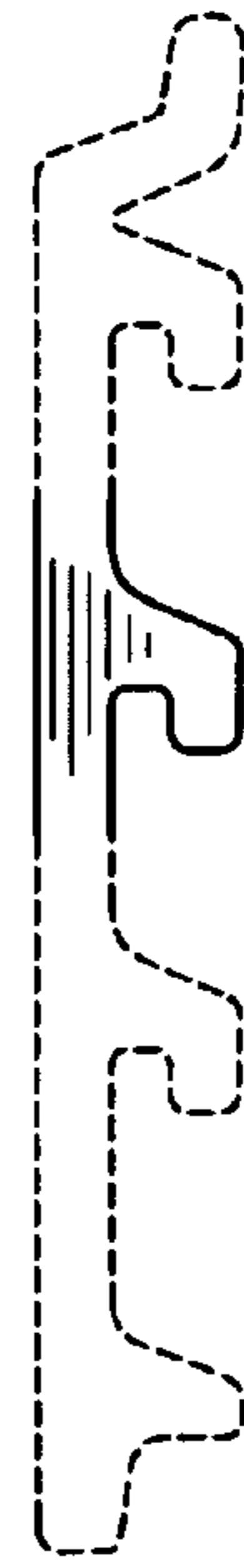

FIG. 8