



US00D620935S

(12) **United States Design Patent**
Chang et al.

(10) **Patent No.:** **US D620,935 S**

(45) **Date of Patent:** **** Aug. 3, 2010**

(54) **DISPLAY**

(75) Inventors: **Chia-Hui Chang**, Chung Ho (TW);
Wei-Ming Shih, Chung Ho (TW)

(73) Assignee: **Amtran Technology Co., Ltd**, Chung
Ho, Taipei County (TW)

(**) Term: **14 Years**

(21) Appl. No.: **29/345,494**

(22) Filed: **Oct. 16, 2009**

(51) **LOC (9) Cl.** **14-02**

(52) **U.S. Cl.** **D14/374**

(58) **Field of Classification Search** D14/371-376,
D14/125-129; 345/104, 156, 168, 173, 87,
345/1.1, 901-905; 341/12; 348/180, 184,
348/325, 739; 349/1, 2, 11, 58; 248/917-924,
248/278.1; 361/679.23, 679.08
See application file for complete search history.

(56) **References Cited**

U.S. PATENT DOCUMENTS

D403,309 S	*	12/1998	Takemasa et al.	D14/374
D424,068 S	*	5/2000	Takemasa	D14/374
D424,538 S	*	5/2000	Hayashi et al.	D14/374
D487,461 S	*	3/2004	Sheu et al.	D14/374
D495,706 S	*	9/2004	Lin et al.	D14/374
D519,117 S	*	4/2006	Lewis	D14/374
D533,149 S	*	12/2006	Inoue	D14/126

D560,369 S	*	1/2008	Chiang	D6/300
D563,335 S	*	3/2008	Murata et al.	D14/126
D564,990 S	*	3/2008	Ueno	D14/126
D578,495 S	*	10/2008	Yokota	D14/126
D580,896 S	*	11/2008	Niitsu	D14/126
D585,062 S	*	1/2009	Ding et al.	D14/375
D589,510 S	*	3/2009	Wada	D14/371
D600,695 S	*	9/2009	Niitsu et al.	D14/371

* cited by examiner

Primary Examiner—Freda S Nunn

(74) *Attorney, Agent, or Firm*—Morris, Manning & Martin
LLP; Tim Tingkang Xia

(57) **CLAIM**

The ornamental design for a “display,” as shown and
described.

DESCRIPTION

FIG. 1 is a perspective view of display showing our new
design;

FIG. 2 is a front view thereof;

FIG. 3 is a rear view thereof;

FIG. 4 is a left side elevational view thereof;

FIG. 5 is a right side elevational view thereof;

FIG. 6 is a top view thereof; and,

FIG. 7 is a bottom view thereof.

1 Claim, 5 Drawing Sheets

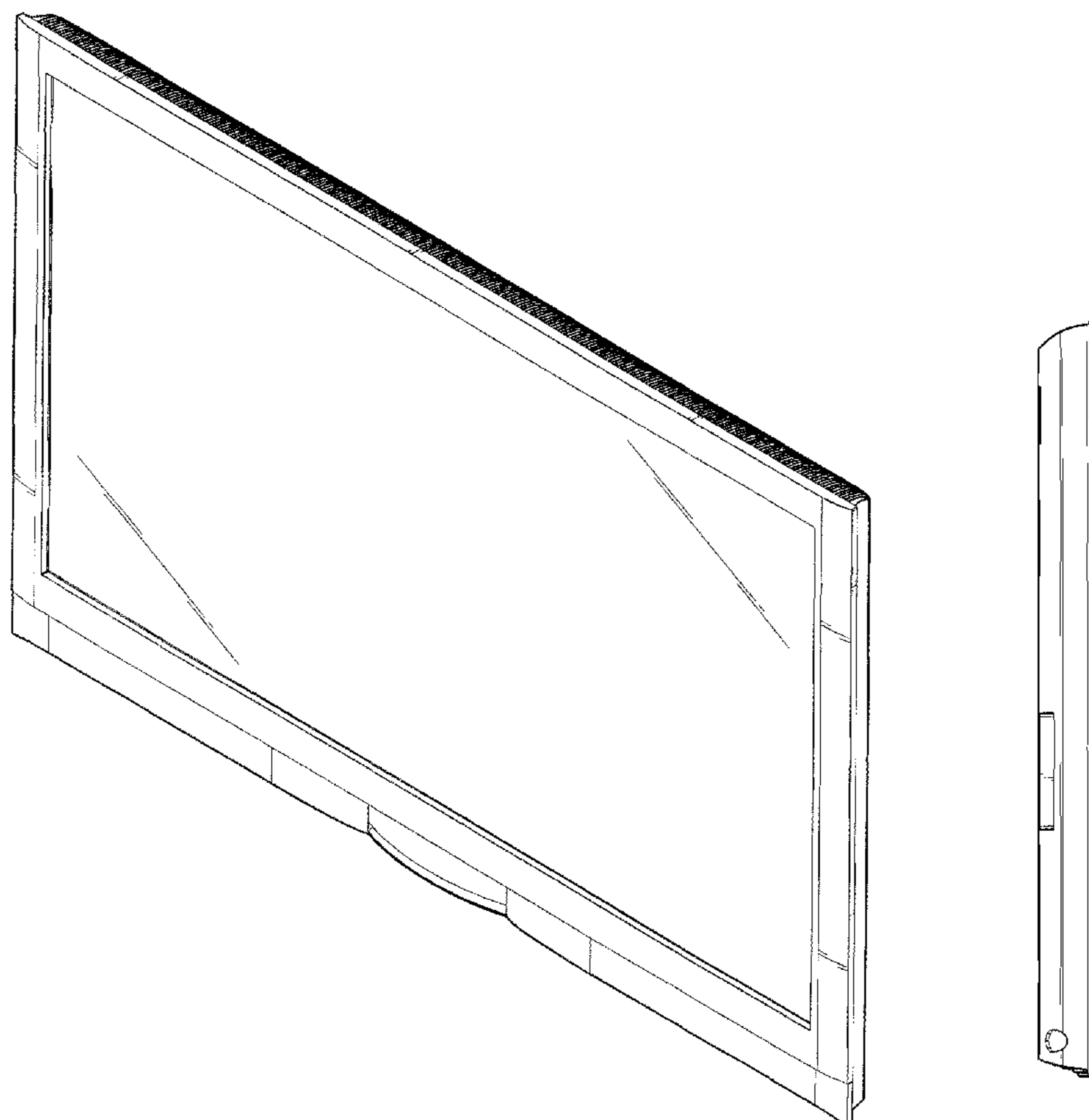

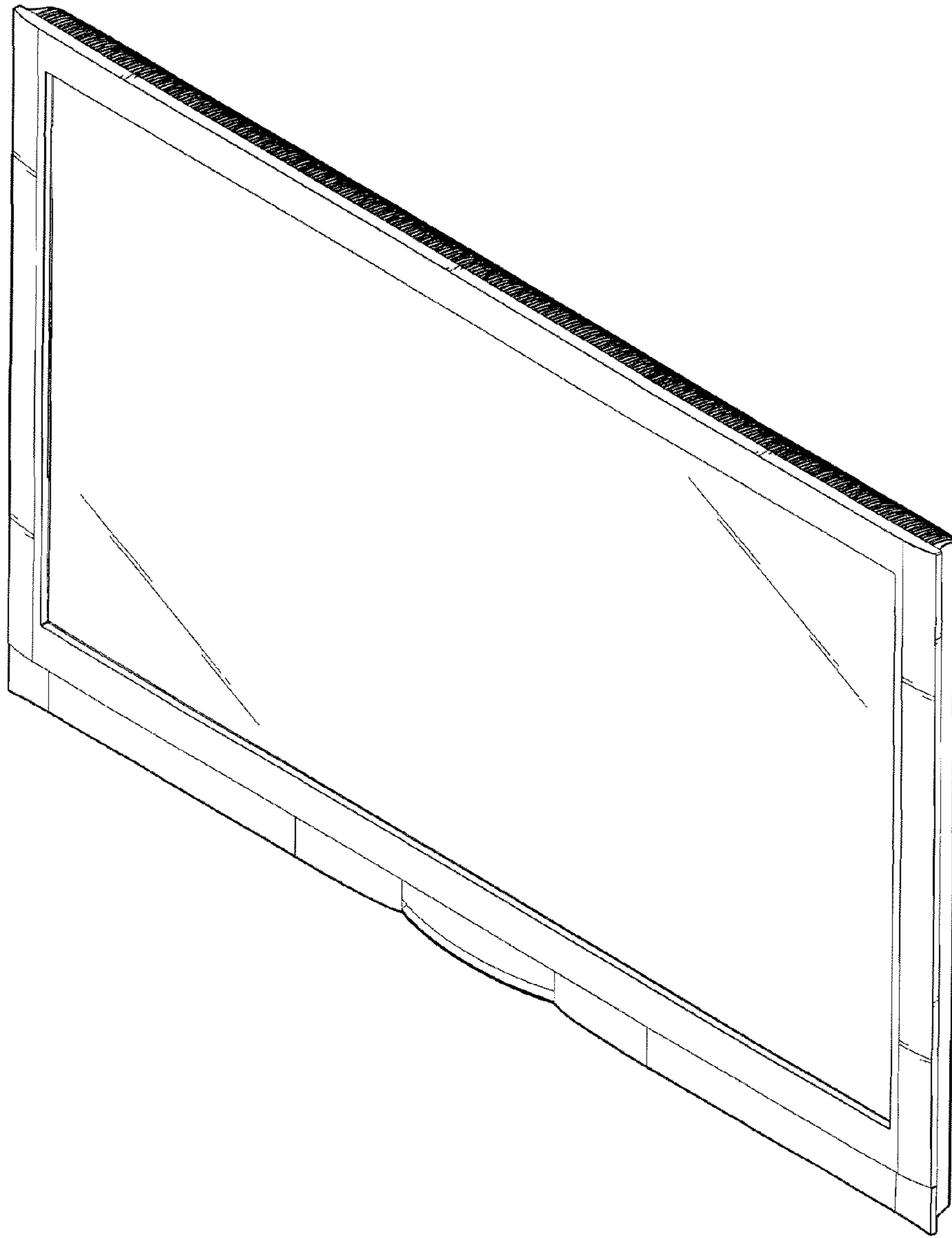

FIG.1

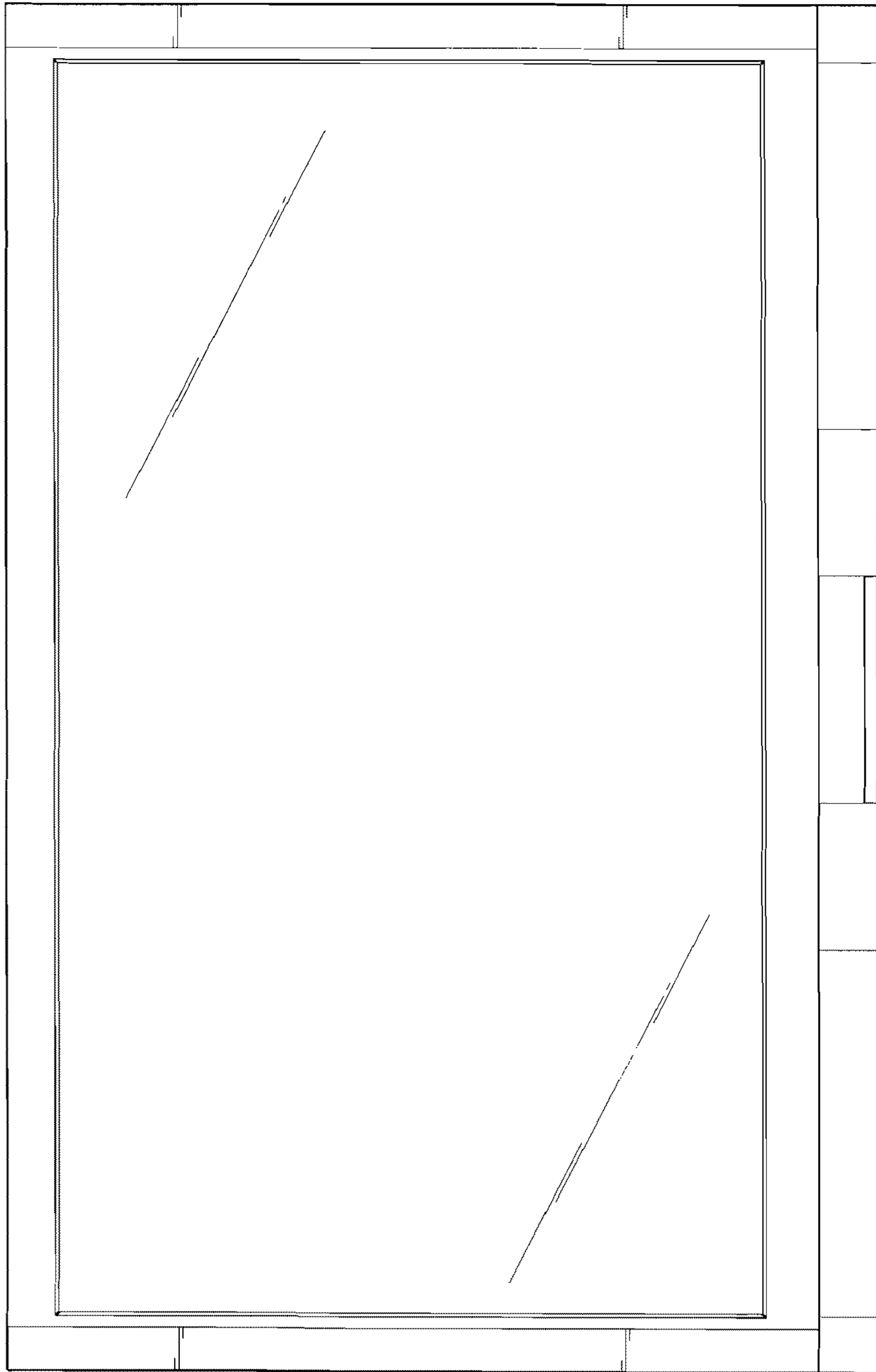

FIG.2

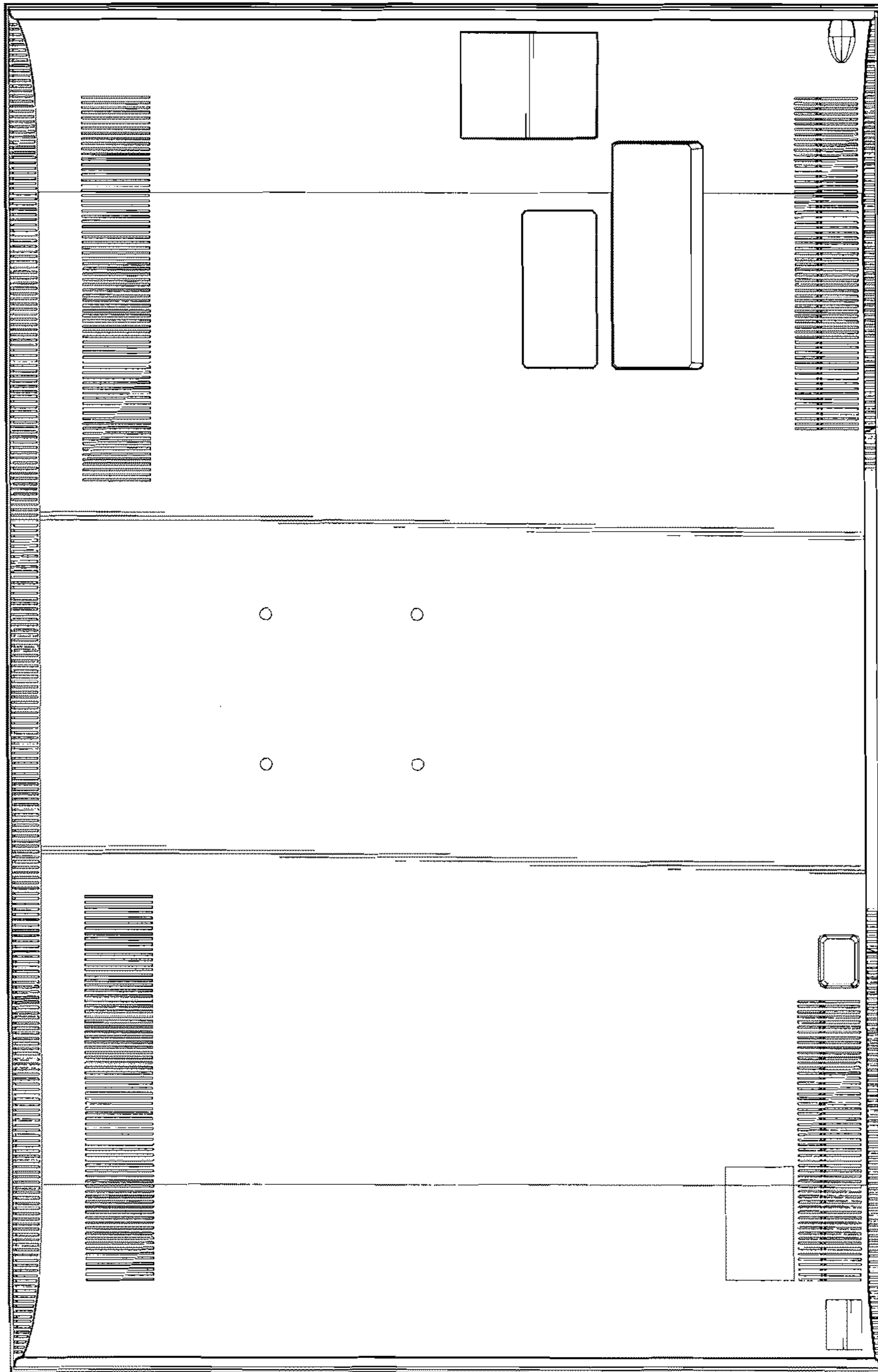

FIG. 3

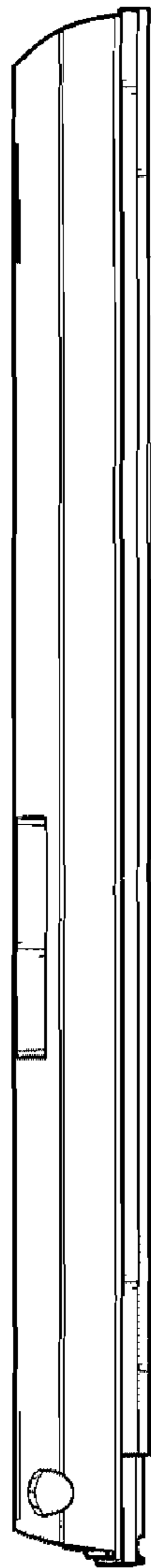

FIG. 4

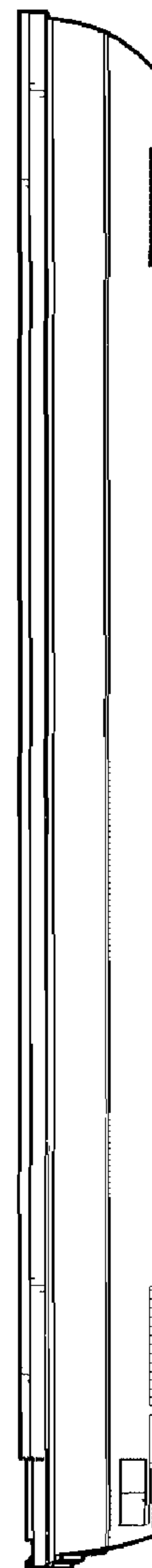

FIG. 5

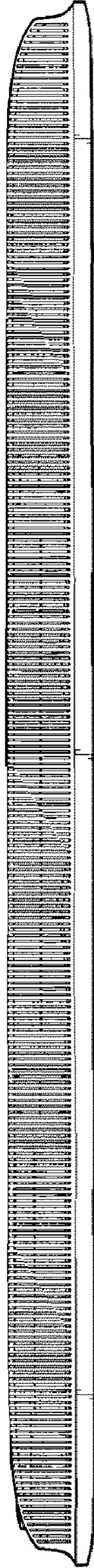

FIG. 6

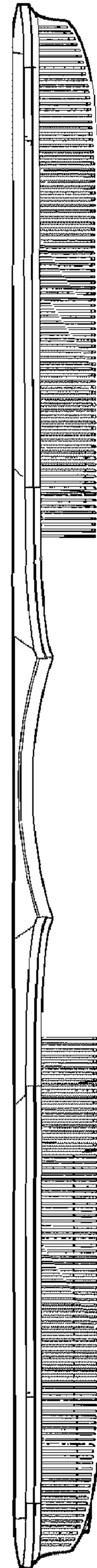

FIG. 7