



US00D620914S

(12) **United States Design Patent**
Suk et al.

(10) **Patent No.:** **US D620,914 S**

(45) **Date of Patent:** **** Aug. 3, 2010**

(54) **MOBILE PHONE**

(75) Inventors: **Chang-Hoon Suk**, Seoul (KR);
Beom-Ku Han, Seoul (KR);
Chang-Hwan Hwang, Goyang-si (KR)

(73) Assignee: **Samsung Electronics Co., Ltd.**,
Suwon-Si (KR)

(**) Term: **14 Years**

(21) Appl. No.: **29/346,743**

(22) Filed: **Nov. 5, 2009**

(30) **Foreign Application Priority Data**

Jul. 10, 2009 (KR) 30-2009-0030599

(51) **LOC (9) Cl.** **14-03**

(52) **U.S. Cl.** **D14/138 AD**

(58) **Field of Classification Search** D14/138 R,
D14/138 AD, 138 AC, 138 C, 138 G, 191,
D14/203.1-203.8, 496, 138 AA, 138 AB,
D14/247-248, 137, 147, 218, 341-347; D10/65,
D10/78, 104; D13/168; D18/7; 455/566,
455/575.1, 575.3

See application file for complete search history.

(56) **References Cited**

U.S. PATENT DOCUMENTS

D519,998 S * 5/2006 Park D14/346
D545,289 S * 6/2007 Wang D14/138 AD
D545,292 S * 6/2007 Lee et al. D14/138 AD
D547,296 S * 7/2007 Lin D14/138 AD
D549,205 S * 8/2007 Cho D14/138 AD
D551,201 S * 9/2007 Kim et al. D14/138 AD
D558,176 S * 12/2007 Lee et al. D14/138 AD
D560,191 S * 1/2008 Choi et al. D14/138 AD
D561,512 S * 2/2008 Park et al. D14/138 AD
D562,298 S * 2/2008 Yoon D14/138 AD
D563,369 S * 3/2008 Kim et al. D14/138 AD

D564,921 S * 3/2008 Cheng D10/65

D569,365 S * 5/2008 Shin et al. D14/138 AC

D572,685 S * 7/2008 Peng D14/138 G

D576,596 S * 9/2008 Moon et al. D14/138 AD

(Continued)

OTHER PUBLICATIONS

Asus P565, announced Nov. 2008, [online], [retrieved on Nov. 26, 2008]. Retrieved from Internet ,<URL: <http://www.gsmarena.com>>.*

(Continued)

Primary Examiner—Jeffrey D Asch

Assistant Examiner—Bridget L Eland

(74) *Attorney, Agent, or Firm*—Staas & Halsey LLP

(57) **CLAIM**

The ornamental design for a mobile phone, as shown and described.

DESCRIPTION

FIG. 1 is a front perspective view of a mobile phone;
FIG. 2 is a front view of the mobile phone of FIG. 1;
FIG. 3 is a rear view of the mobile phone of FIG. 1;
FIG. 4 is a left-side view of the mobile phone of FIG. 1;
FIG. 5 is a right-side view of the mobile phone of FIG. 1;
FIG. 6 is a top plan view of the mobile phone of FIG. 1;
FIG. 7 is a bottom plan view of the mobile phone of FIG. 1;
and,
FIG. 8 is a front perspective open view of the mobile phone of FIG. 1.

1 Claim, 5 Drawing Sheets

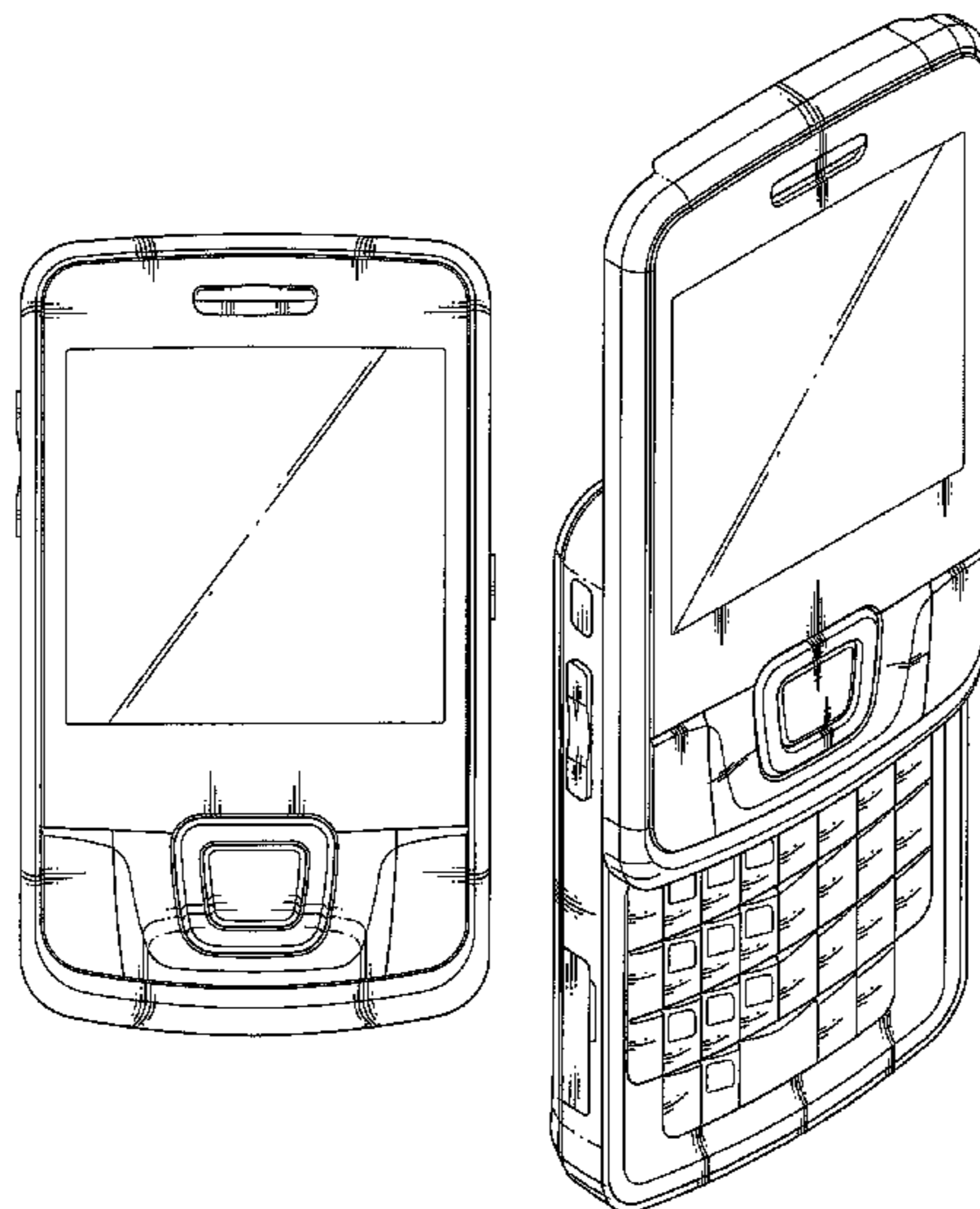

US D620,914 S

Page 2

U.S. PATENT DOCUMENTS

D578,095 S * 10/2008 Chung et al. D14/138 AD
D584,708 S * 1/2009 Wu et al. D14/138 AD
D584,709 S * 1/2009 Chiang D14/138 AD
7,555,312 B2 * 6/2009 Kim et al. 455/556.1
D599,319 S * 9/2009 Asmussen D14/138 AD
D601,107 S * 9/2009 Kim et al. D14/138 AD
D602,895 S * 10/2009 Chun D14/138 AD
2007/0021160 A1 * 1/2007 Li 455/575.4
2007/0072659 A1 * 3/2007 Ryu 455/575.3
2008/0058007 A1 * 3/2008 Kang 455/556.1

2010/0056213 A1* 3/2010 Chang et al. 455/556.2

OTHER PUBLICATIONS

LG KG290, announced Sep. 2007, [online], [retrieved on Dec. 13, 2007]. Retrieved from Internet ,<URL: <http://www.gsmarena.com>>.*

Samsung D820, announced 4th quarter 2005, [online], [retrieved on Feb. 8, 2007]. Retrieved from Internet ,<URL: <http://www.gsmarena.com>>.*

* cited by examiner

FIG. 1

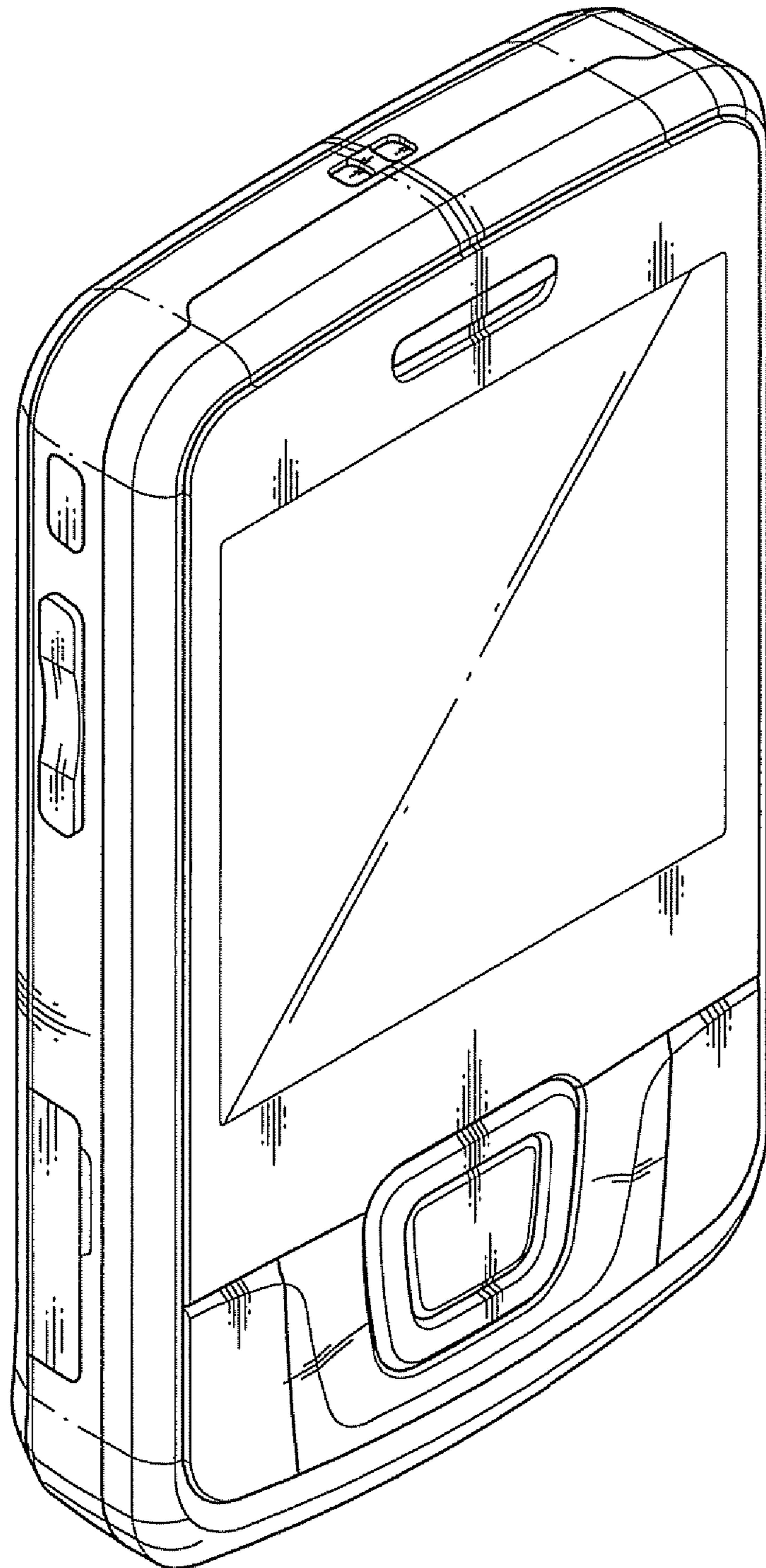

FIG. 2

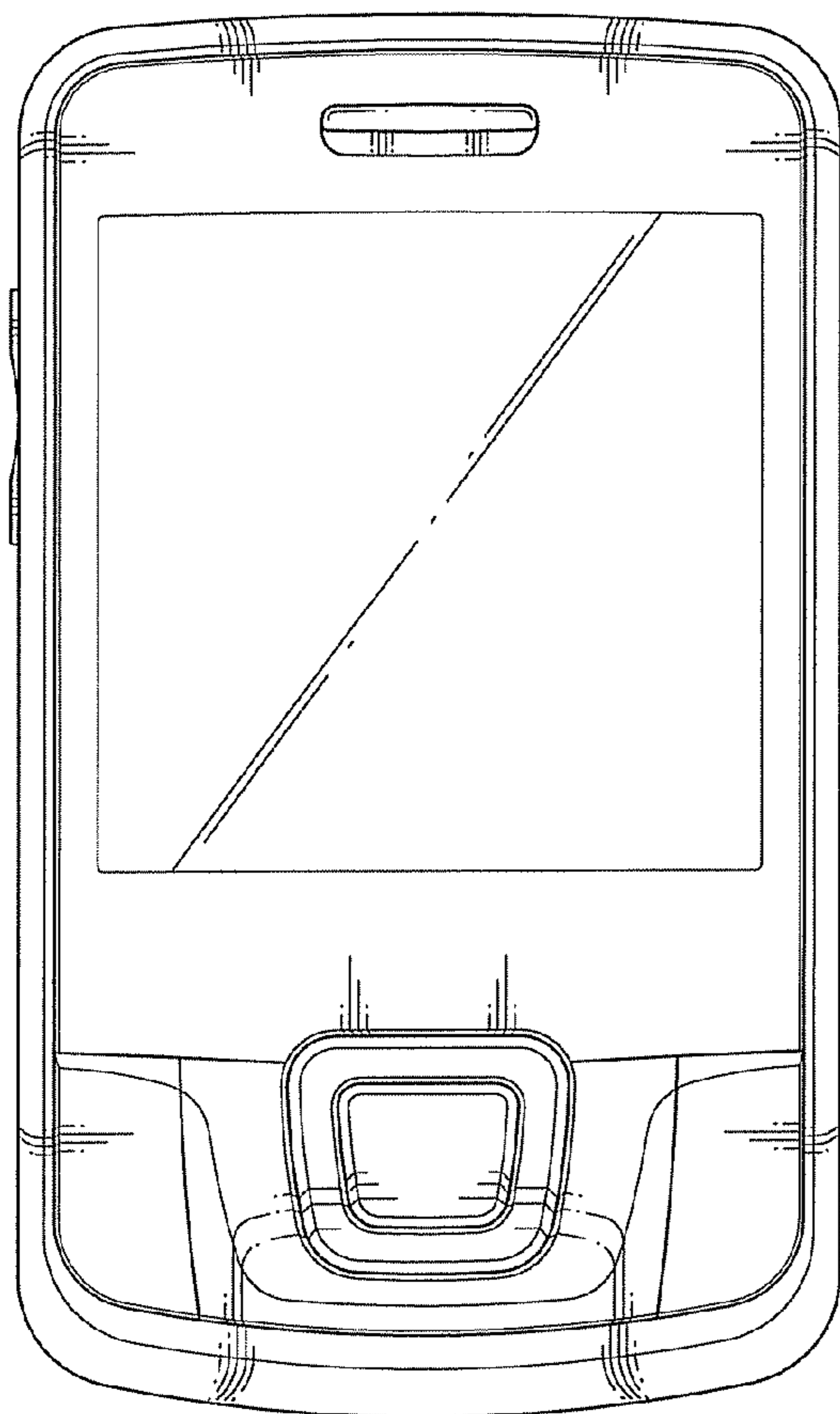

FIG. 3

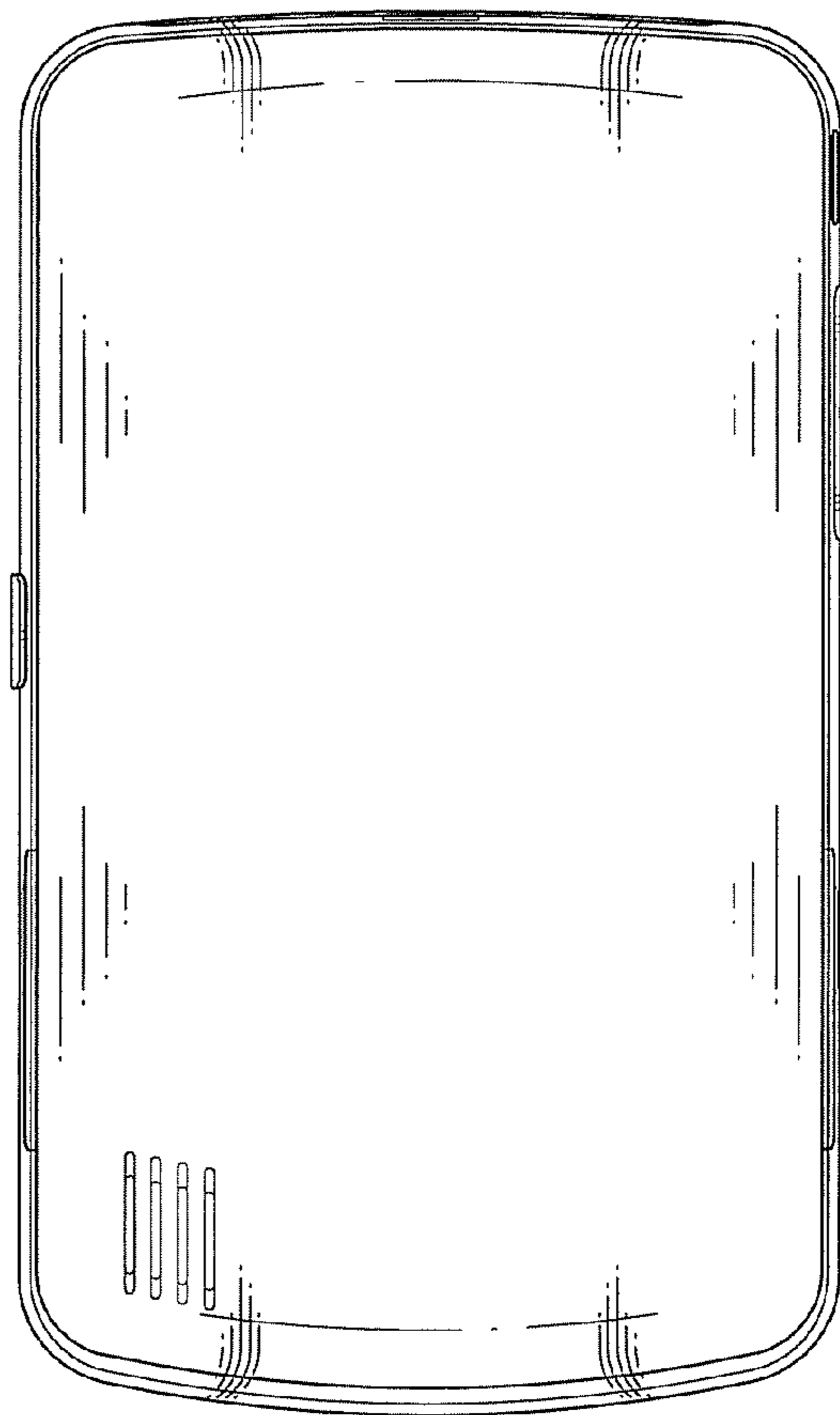

FIG. 4

FIG. 5

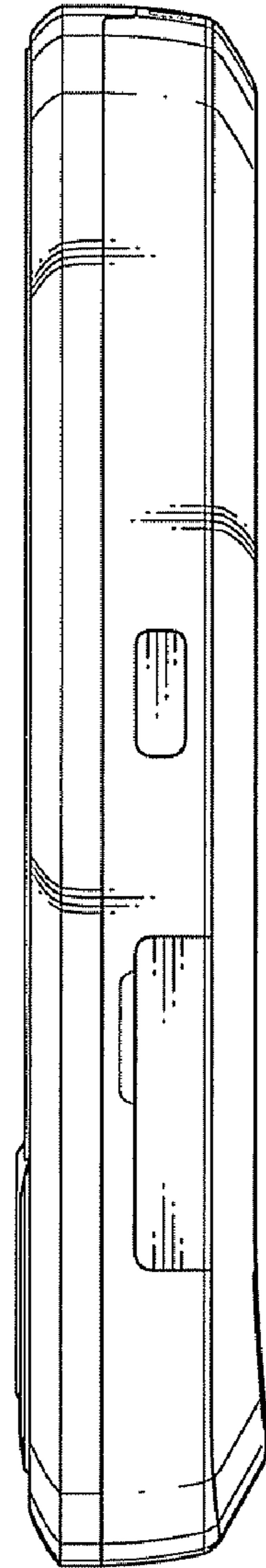
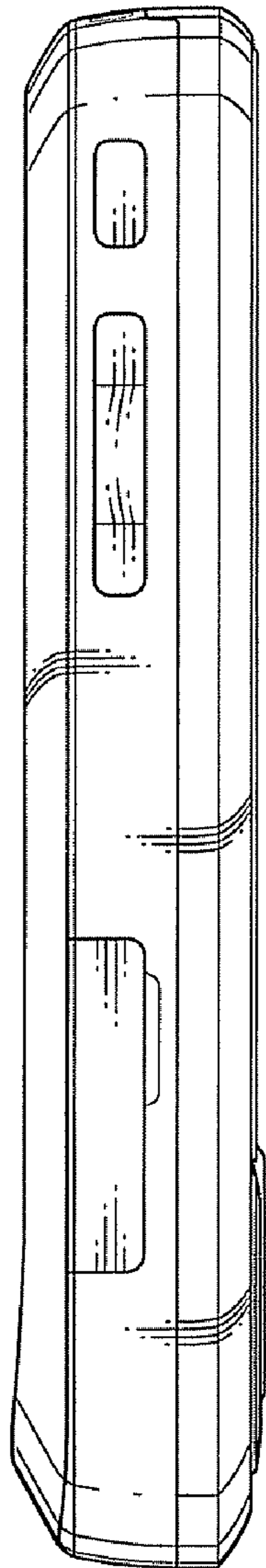

FIG. 6

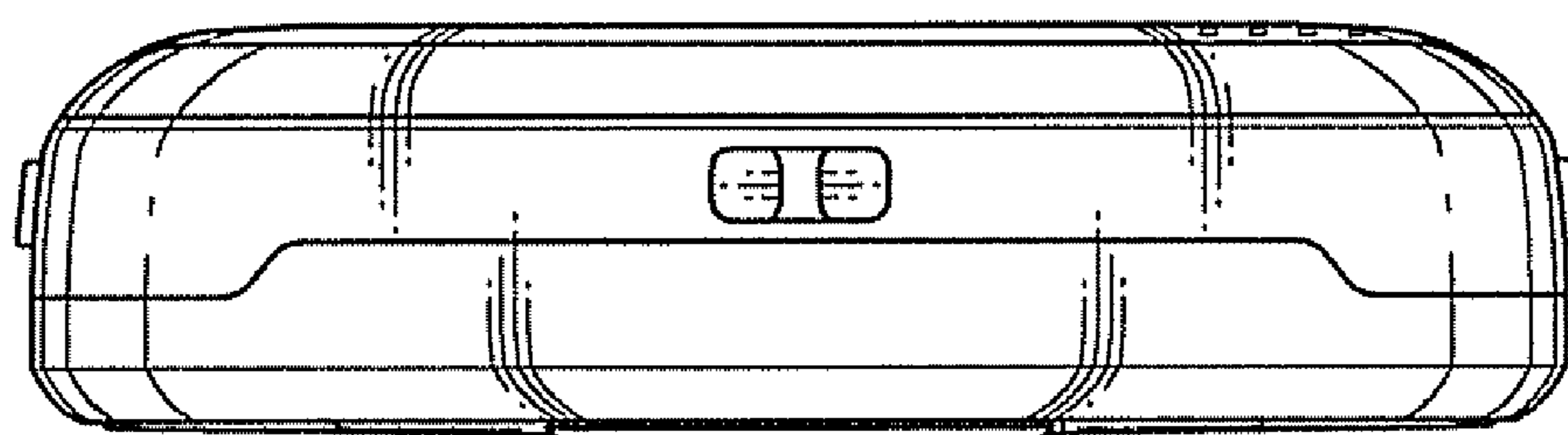

FIG. 7

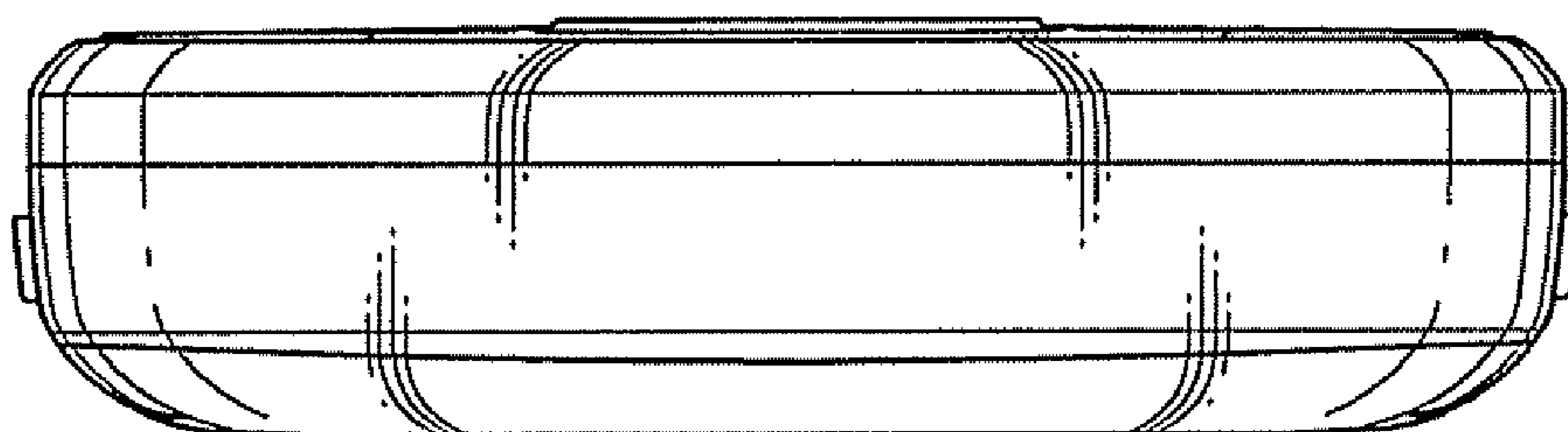

FIG. 8

