

US00D620911S

(12) **United States Design Patent**
Kim et al.

(10) **Patent No.:** **US D620,911 S**

(45) **Date of Patent:** **** Aug. 3, 2010**

(54) **MOBILE PHONE**

(75) Inventors: **Jin-Soo Kim**, Yongin-si (KR);
Min-Hyouk Lee, Seoul (KR);
Seog-Guen Kim, Seoul (KR)

(73) Assignee: **Samsung Electronics Co., Ltd.**,
Suwon-si (KR)

(**) Term: **14 Years**

(21) Appl. No.: **29/345,469**

(22) Filed: **Oct. 16, 2009**

(30) **Foreign Application Priority Data**

Sep. 11, 2009 (KR) 30-2009-0040344

(51) **LOC (9) Cl.** **14-03**

(52) **U.S. Cl.** **D14/138 AA**

(58) **Field of Classification Search** D14/341-347,
D14/147, 496, 203.3, 203.4, 203.7, 138 AA,
D14/138 R, 138 AD; 455/575.1, 575.4, 556.2;
379/433.01, 433.04

See application file for complete search history.

(56) **References Cited**

U.S. PATENT DOCUMENTS

- D496,343 S * 9/2004 Lin et al. D14/138 AA
- D496,921 S * 10/2004 Hwang D14/138 AA
- D502,933 S * 3/2005 Munstermann D14/138 AA
- D515,534 S * 2/2006 Park et al. D14/138 AA
- D528,098 S * 9/2006 Corley et al. D14/138 AA
- D543,184 S * 5/2007 Moon et al. D14/138 AA
- D543,187 S * 5/2007 Lee et al. D14/138 AA
- D543,530 S * 5/2007 Ahn et al. D14/138 AA
- D547,744 S * 7/2007 Kim et al. D14/138 AA
- D556,727 S * 12/2007 Cha et al. D14/138 AA
- D558,707 S * 1/2008 Travis et al. D14/138 AA

- D562,297 S * 2/2008 Kim et al. D14/138 AA
- D579,909 S * 11/2008 Huang et al. D14/138 AA
- D583,350 S * 12/2008 Park et al. D14/138 AA
- D585,414 S * 1/2009 Kim et al. D14/138 AA
- 7,509,151 B1 * 3/2009 Edwards 455/575.1
- D608,319 S * 1/2010 Nuovo D14/138 AA
- D609,204 S * 2/2010 Kim et al. D14/138 AA
- D610,116 S * 2/2010 He D14/138 AA
- D610,120 S * 2/2010 Chung et al. D14/138 AA

(Continued)

OTHER PUBLICATIONS

Samsung S5350 Shark telephone, announced Jan. 2010, [online], [site visited Mar. 26, 2010]. Available from Internet, <URL: http://www.gsmarena.com>.*

(Continued)

Primary Examiner—Jeffrey D Asch
(74) *Attorney, Agent, or Firm*—NSIP Law

(57) **CLAIM**

The ornamental design for a mobile phone, as shown and described.

DESCRIPTION

FIG. 1 is a perspective view of a mobile phone;
FIG. 2 is a front view of the mobile phone of FIG. 1;
FIG. 3 is a rear view of the mobile phone of FIG. 1;
FIG. 4 is a left-side view of the mobile phone of FIG. 1;
FIG. 5 is a right-side view of the mobile phone of FIG. 1;
FIG. 6 is a top plan view of the mobile phone of FIG. 1; and,
FIG. 7 is a bottom plan view of the mobile phone of FIG. 1.

1 Claim, 5 Drawing Sheets

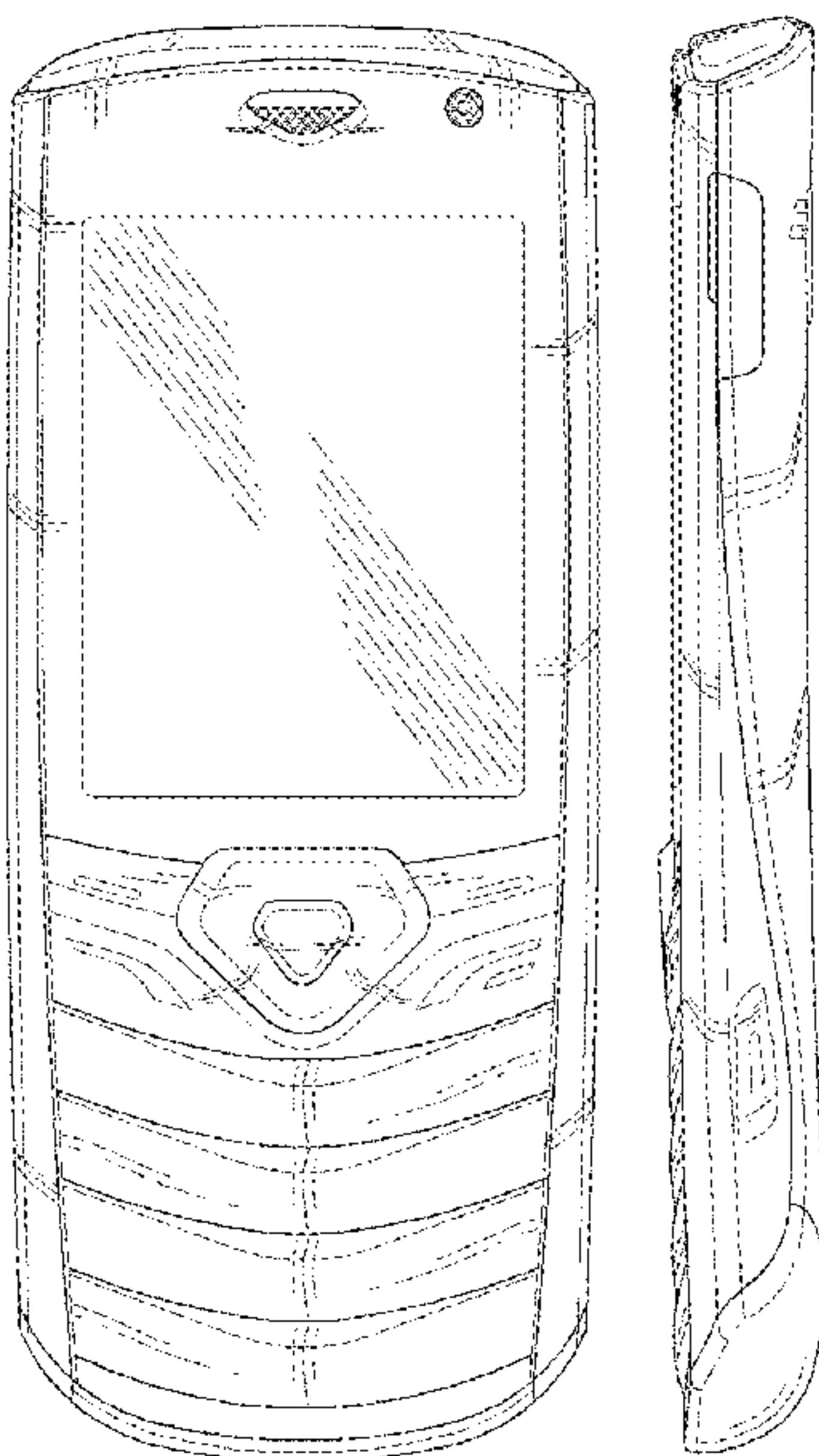

U.S. PATENT DOCUMENTS

2005/0233785 A1* 10/2005 Park et al. 455/575.4

OTHER PUBLICATIONS

Samsung C3200 Monte Bar telephone, announced Feb. 2010, [online], [site visited Mar. 26, 2010]. Available from Internet, <URL: <http://www.gsmarena.com>>.*

Samsung E200 ECO telephone, announced Aug. 2008, [online], [site visited Mar. 26, 2010]. Available from Internet, <URL: <http://www.gsmarena.com>>.*

Motorola A835 telephone, announced 2003, [online], [site visited Mar. 26, 2010]. Available from Internet, <URL: <http://www.gsmarena.com>>.*

Motorola MPx100 telephone, announced 1st quarter 2004, [online], [site visited Mar. 26, 2010]. Available from Internet, <URL: <http://www.gsmarena.com>>.*

LG G5310 telephone, announced 3rd quarter 2003, [online], [site visited Mar. 26, 2010]. Available from Internet, <URL: <http://www.gsmarena.com>>.*

Philips 568 telephone, announced 4th quarter 2004, [online], [site visited Mar. 26, 2010]. Available from Internet, <URL: <http://www.gsmarena.com>>.*

Vertu Ascent ti telephone, announced Jul. 2007, [online], [site visited Mar. 26, 2010]. Available from Internet, <URL: <http://www.gsmarena.com>>.*

Samsung S5550 Shark 2 telephone, announced Jan. 2010, [online], [site visited Mar. 26, 2010]. Available from Internet, <URL: <http://www.gsmarena.com>>.*

* cited by examiner

FIG. 1

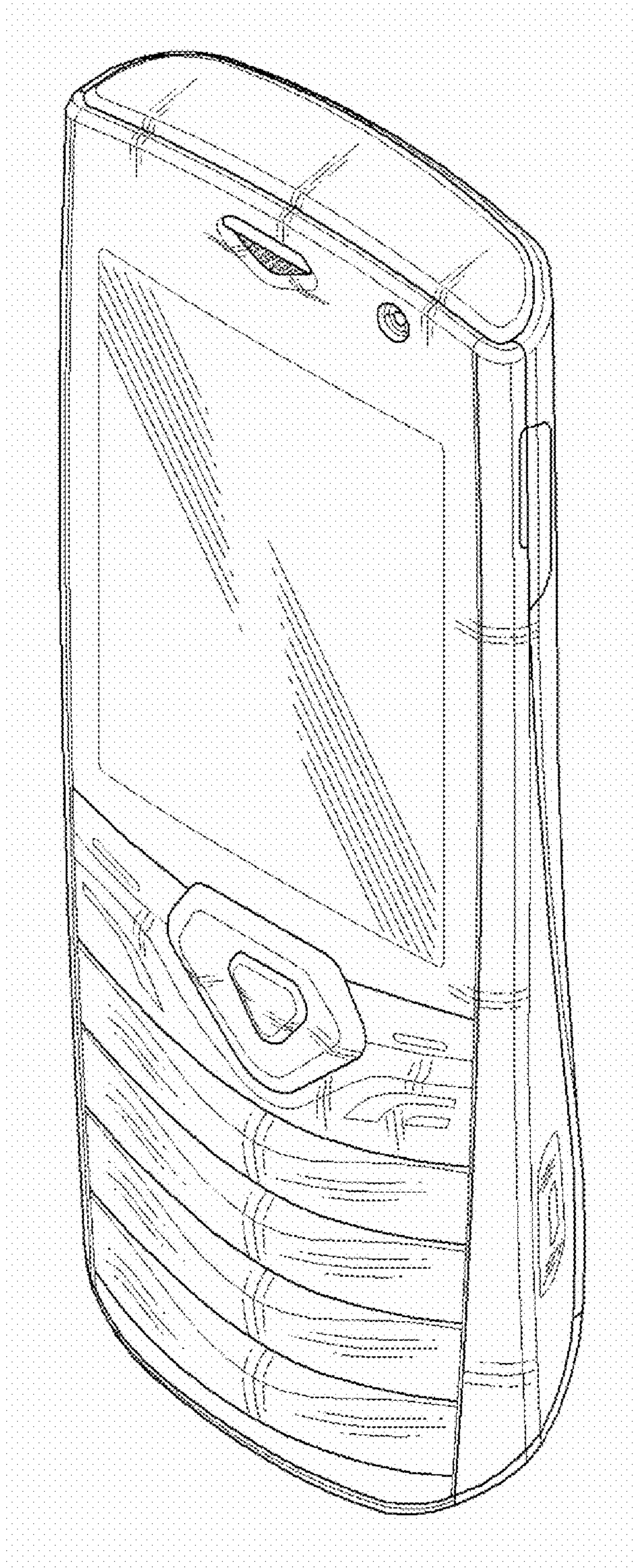

FIG. 2

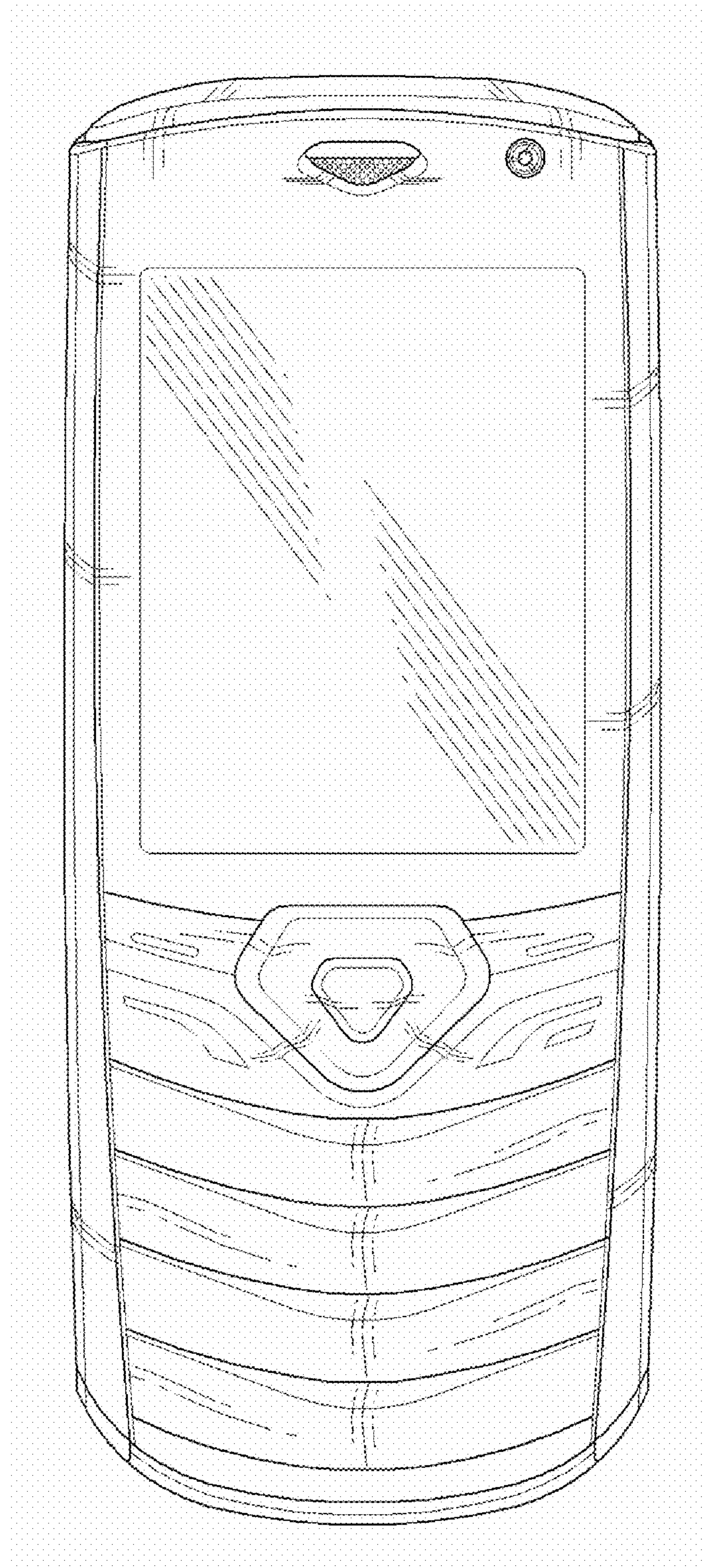

FIG. 3

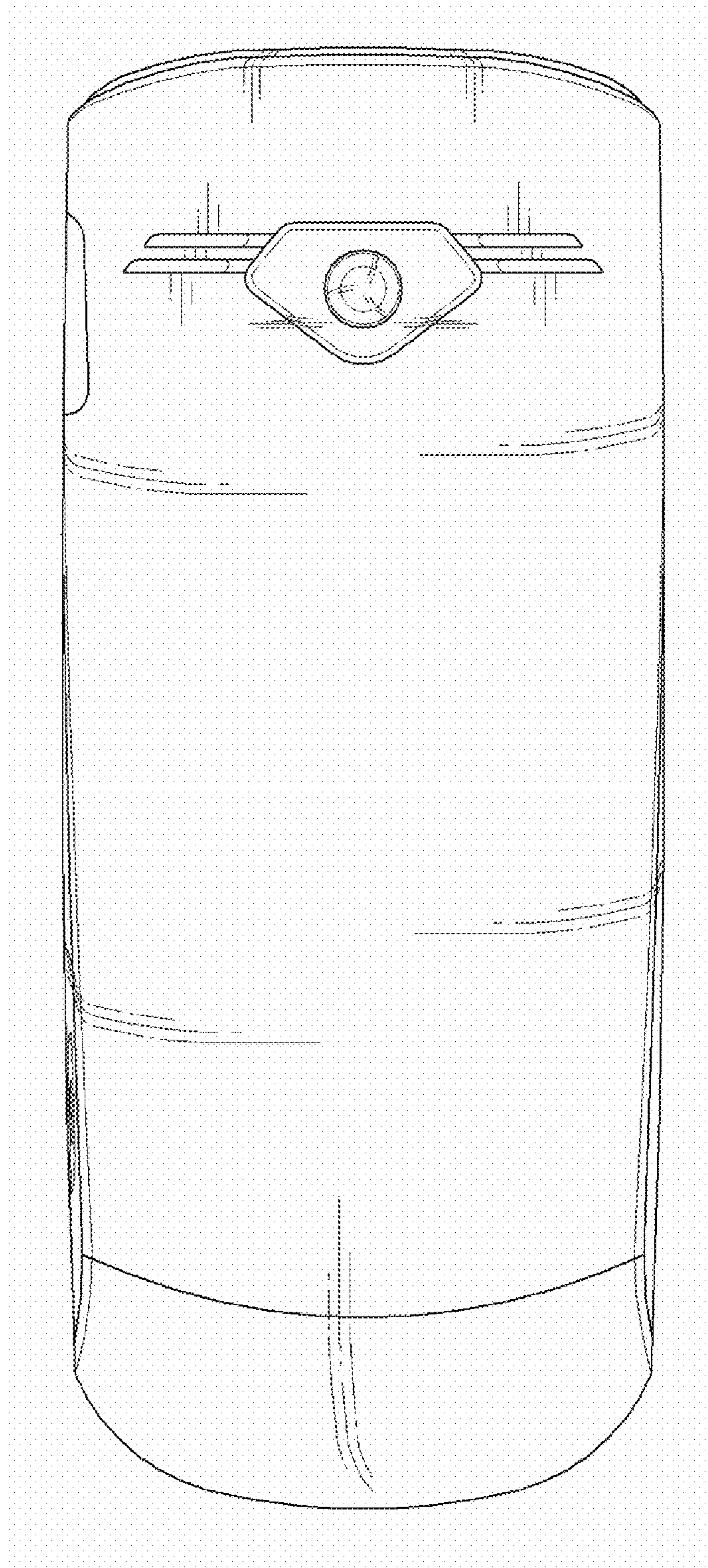

FIG. 4

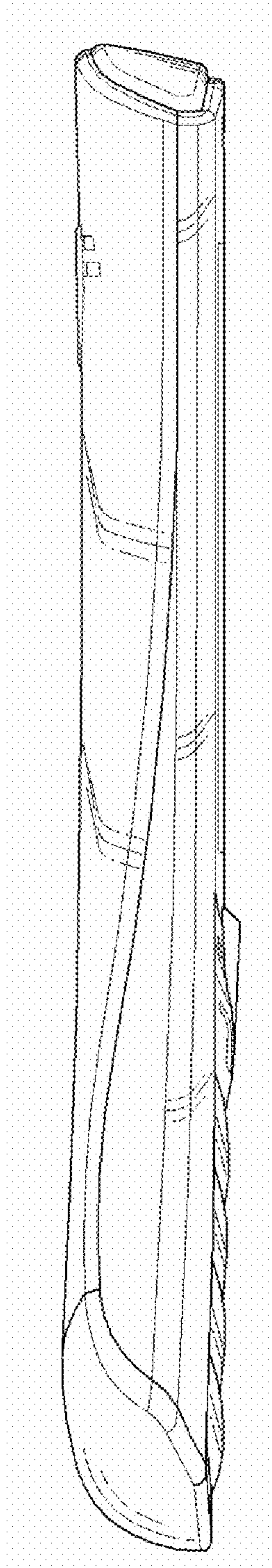

FIG. 5

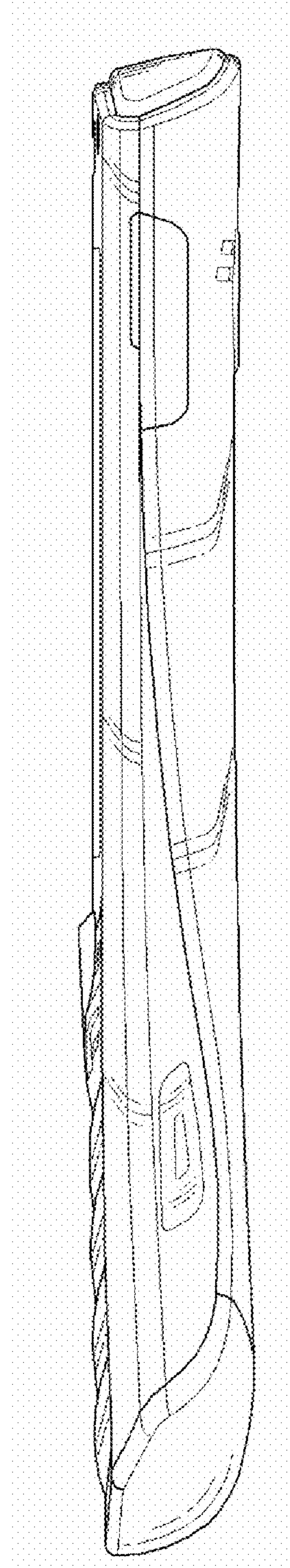

FIG. 6

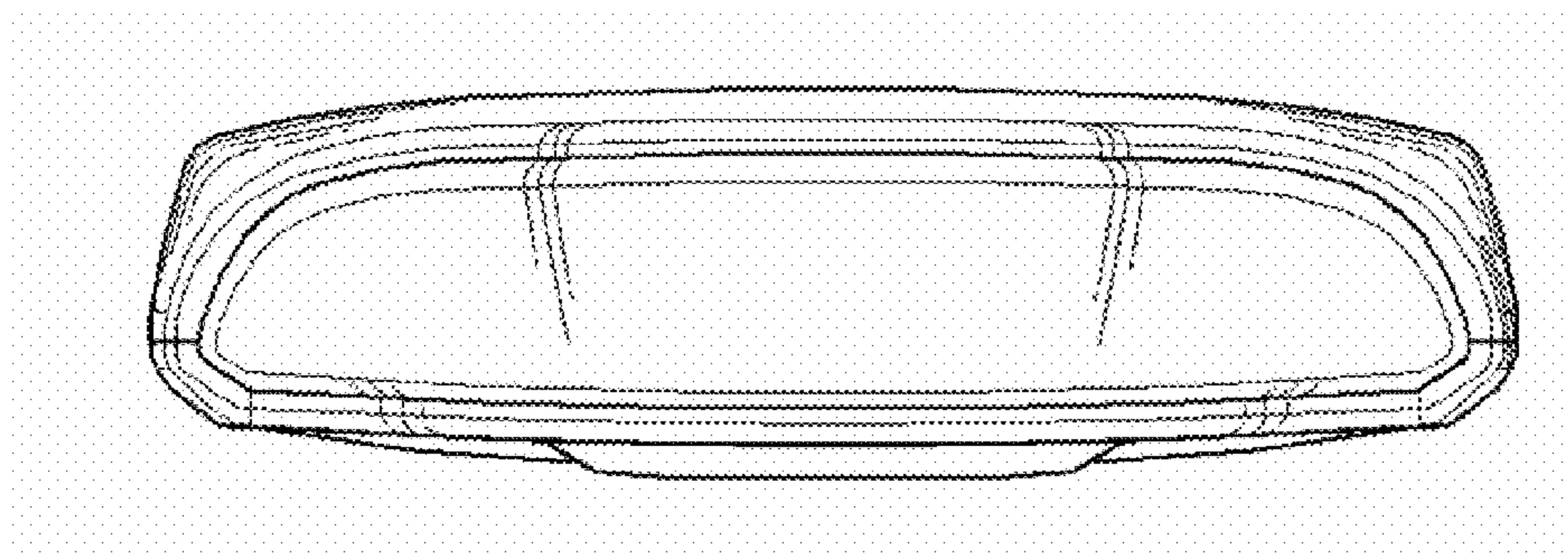

FIG. 7

