



US00D620817S

(12) **United States Design Patent**
Eide et al.

(10) **Patent No.:** **US D620,817 S**
(45) **Date of Patent:** **** Aug. 3, 2010**

(54) **MEASURING CONTAINER**

1,674,475 A 6/1928 Loomis

(Continued)

(75) Inventors: **Annbjorg Eide**, Elmira, NY (US); **Nao Tamaru**, Brooklyn, NY (US)

FOREIGN PATENT DOCUMENTS

(73) Assignee: **WKI Holding Company, Inc.**, Rosemont, IL (US)

FR 2766692 7/1997

(Continued)

(**) Term: **14 Years**

OTHER PUBLICATIONS

(21) Appl. No.: **29/344,930**

Chef's Catalog, p. 72, OXO measuring cup.

(22) Filed: **Oct. 6, 2009**

Primary Examiner—Terry A Wallace

(74) Attorney, Agent, or Firm—McDermott Will & Emery LLP

Related U.S. Application Data

(63) Continuation of application No. 29/334,175, filed on Mar. 21, 2009, now abandoned.

(57) **CLAIM**

We claim the ornamental design for a measuring container, as shown and described.

(51) **LOC (9) Cl.** **10-04**

(52) **U.S. Cl.** **D10/46.2**

(58) **Field of Classification Search** D7/509,
D7/523, 316; D10/46.2, 46.3; 73/426-429;
206/514; 222/158

DESCRIPTION

See application file for complete search history.

FIG. 1 is a perspective view of a measuring container according to the new design;

FIG. 2 is a front view of a measuring container according to the new design shown in FIG. 1;

FIG. 3 is a left side elevation view of a measuring container according to the new design shown in FIG. 1;

FIG. 4 is a right side elevation view of a measuring container according to the new design shown in FIG. 1;

FIG. 5 is a top view of the measuring container shown in FIG. 1;

FIG. 6 is a bottom view of the measuring container shown in FIG. 1; and,

FIG. 7 is a rear view of the measuring container shown in FIG. 1.

Features shown in broken lines form no part of the claimed design.

(56) **References Cited**

U.S. PATENT DOCUMENTS

39,346 A	7/1863	Hillman
63,663 A	4/1867	Rand
153,159 A	7/1874	Dinwiddie
217,050 A	7/1879	Block
258,035 A	5/1882	Eastman
432,018 A	7/1890	Young
449,147 A	5/1891	Welch
598,891 A	2/1898	Barnekov
679,628 A	7/1901	Lehmann
925,582 A	6/1909	Kipp
1,105,114 A	7/1914	Tsuru
1,250,890 A	12/1917	Johnson
1,386,571 A	8/1921	Jackson
1,507,968 A	9/1924	Johnson

1 Claim, 4 Drawing Sheets

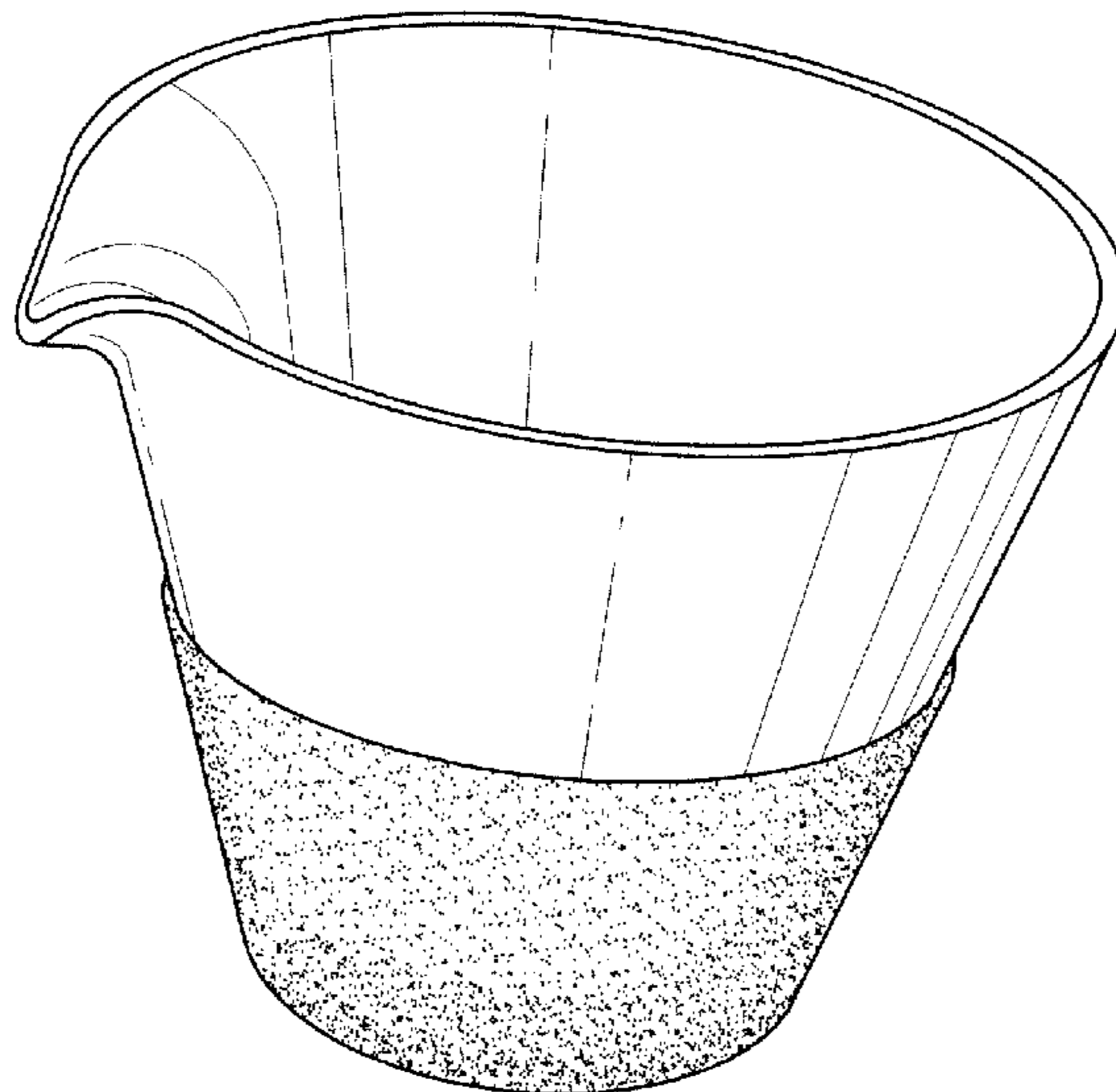

US D620,817 S

Page 2

U.S. PATENT DOCUMENTS					
1,711,796 A	5/1929	Knight	5,863,431 A	1/1999	Salzburg
2,018,271 A	10/1935	Lewis	5,868,063 A	2/1999	Longmuir
2,165,045 A	7/1939	Garside	5,966,214 A	10/1999	Imbrock et al.
2,517,248 A	8/1950	Semeyn	5,988,419 A	11/1999	St. John
2,548,035 A	4/1951	May	6,029,843 A	2/2000	Kroscher et al.
2,758,771 A	7/1956	Bauer	6,048,069 A	4/2000	Nagaoka et al.
3,049,014 A	8/1962	Aue	6,098,029 A	8/2000	Takagi et al.
D202,368 S	9/1965	Feldman	D431,478 S	10/2000	Fortier
D202,369 S	9/1965	Feldman	6,197,438 B1	3/2001	Faulkner
D211,047 S	5/1968	Johnson	6,212,953 B1	4/2001	Bethune
3,530,722 A	9/1970	Miller	6,238,907 B1	5/2001	Schuler-Maloney et al.
3,636,360 A	1/1972	Oishi et al.	6,257,752 B1	7/2001	Browne
3,672,061 A	6/1972	Alessi	6,258,418 B1	7/2001	Rudder et al.
3,832,785 A	9/1974	Miller	6,263,732 B1	7/2001	Hoeting et al.
3,881,102 A	4/1975	Willits et al.	6,331,328 B1	12/2001	Cheng
3,931,741 A	1/1976	Ceccarelli	6,357,130 B1	3/2002	Rank
3,956,565 A	5/1976	Bolen et al.	6,375,031 B1	4/2002	Kwan
3,986,248 A	10/1976	Meshberg et al.	6,454,456 B2	9/2002	Browne
4,040,021 A	8/1977	LeGrand et al.	6,491,992 B1	12/2002	Koizumi et al.
4,115,939 A	9/1978	Marks	6,520,369 B1	2/2003	Cytacki
4,204,021 A	5/1980	Becker	D473,148 S	4/2003	Kleckauskas et al.
4,262,535 A	4/1981	Anderson	6,543,284 B2	4/2003	Hoeting et al.
4,263,362 A	4/1981	Straka	6,613,185 B1	9/2003	Valade et al.
4,332,844 A	6/1982	Hamada et al.	6,630,650 B2	10/2003	Bassill et al.
4,337,295 A	6/1982	Rittler	6,640,992 B1	11/2003	Berger et al.
D268,158 S	3/1983	Doyel	6,649,891 B1	11/2003	Kitko et al.
4,401,500 A	8/1983	Hamada et al.	6,769,302 B1	8/2004	King et al.
4,606,496 A	8/1986	Marx et al.	6,921,787 B2	7/2005	Bate
4,623,565 A	11/1986	Huybrechts et al.	6,930,063 B2	8/2005	Keese
D287,324 S	12/1986	Schmidt	D514,458 S *	2/2006	Lawson et al. D10/46.2
D287,325 S	12/1986	Schmidt	D518,392 S	4/2006	Kaposi
4,641,025 A	2/1987	Miller	D530,632 S	10/2006	Kaposi
4,659,851 A	4/1987	Plueddemann	D532,321 S	11/2006	Heiligenstein et al.
4,745,139 A	5/1988	Haasl et al.	D542,077 S	5/2007	Claypool et al.
4,754,013 A	6/1988	Antonen	D548,114 S	8/2007	Sawhney et al.
4,767,015 A	8/1988	Ho	D548,115 S	8/2007	Sawhney et al.
4,814,230 A	3/1989	Vockler	RE39,827 E	9/2007	Hoeting et al.
4,860,906 A	8/1989	Pellegrini et al.	7,306,120 B2	12/2007	Hughes
4,906,686 A	3/1990	Suzuki et al.	D559,029 S	1/2008	Gonzalez et al.
4,959,903 A	10/1990	Daoust et al.	D559,634 S	1/2008	Chan
4,959,937 A	10/1990	Mayer	D577,615 S	9/2008	Markfelder
4,961,996 A	10/1990	Carre et al.	D582,297 S	12/2008	Vendl et al.
D316,529 S	4/1991	Beckman, Sr.	D582,798 S	12/2008	Mantilla et al.
5,034,061 A	7/1991	Maguire et al.	2001/0042402 A1	11/2001	Hoeting et al.
5,043,369 A	8/1991	Bahn et al.	2002/0029635 A1	3/2002	Kremen
5,158,193 A	10/1992	Chen	2003/0079823 A1	5/2003	Sabia
5,235,853 A	8/1993	Froes	2003/0219583 A9	7/2003	Koizumi et al.
5,335,769 A	8/1994	Klokkers-Bethke et al.	2003/0227119 A1	12/2003	Jackson
5,364,921 A	11/1994	Gray et al.	2004/0072942 A1	4/2004	Chen
5,411,771 A	5/1995	Tsai	2004/0112903 A1	6/2004	LoGiudice et al.
5,424,135 A	6/1995	Murata et al.	2006/0179743 A1	8/2006	Kishbaugh et al.
5,445,023 A	8/1995	Reed	2006/0248851 A1	11/2006	Kishbaugh et al.
5,445,102 A	8/1995	Tsai	2006/0277994 A1	12/2006	Peterson
5,576,054 A	11/1996	Brown	2007/0022810 A1	2/2007	Price et al.
5,584,414 A	12/1996	Neubeck	2007/0068250 A1	3/2007	Krent
5,607,078 A	3/1997	Nordberg et al.	2008/0006643 A1	1/2008	Ma
5,644,976 A	7/1997	Muchin et al.	2008/0017540 A1	1/2008	Sawhney et al.
5,691,067 A	11/1997	Patel	2008/0282797 A1	11/2008	Saller et al.
5,699,937 A	12/1997	Canela	2008/0306438 A1	12/2008	Ferrara
D394,217 S	5/1998	Laib			
5,806,410 A	9/1998	Muchin et al.			
5,813,638 A	9/1998	Morris			
5,823,046 A	10/1998	Schagerstrom et al.			
5,860,559 A	1/1999	Wang			

FOREIGN PATENT DOCUMENTS

JP	61160024	7/1986
JP	2000304590	11/2000
WO	02/26087 A2	4/2002

* cited by examiner

FIG. 1

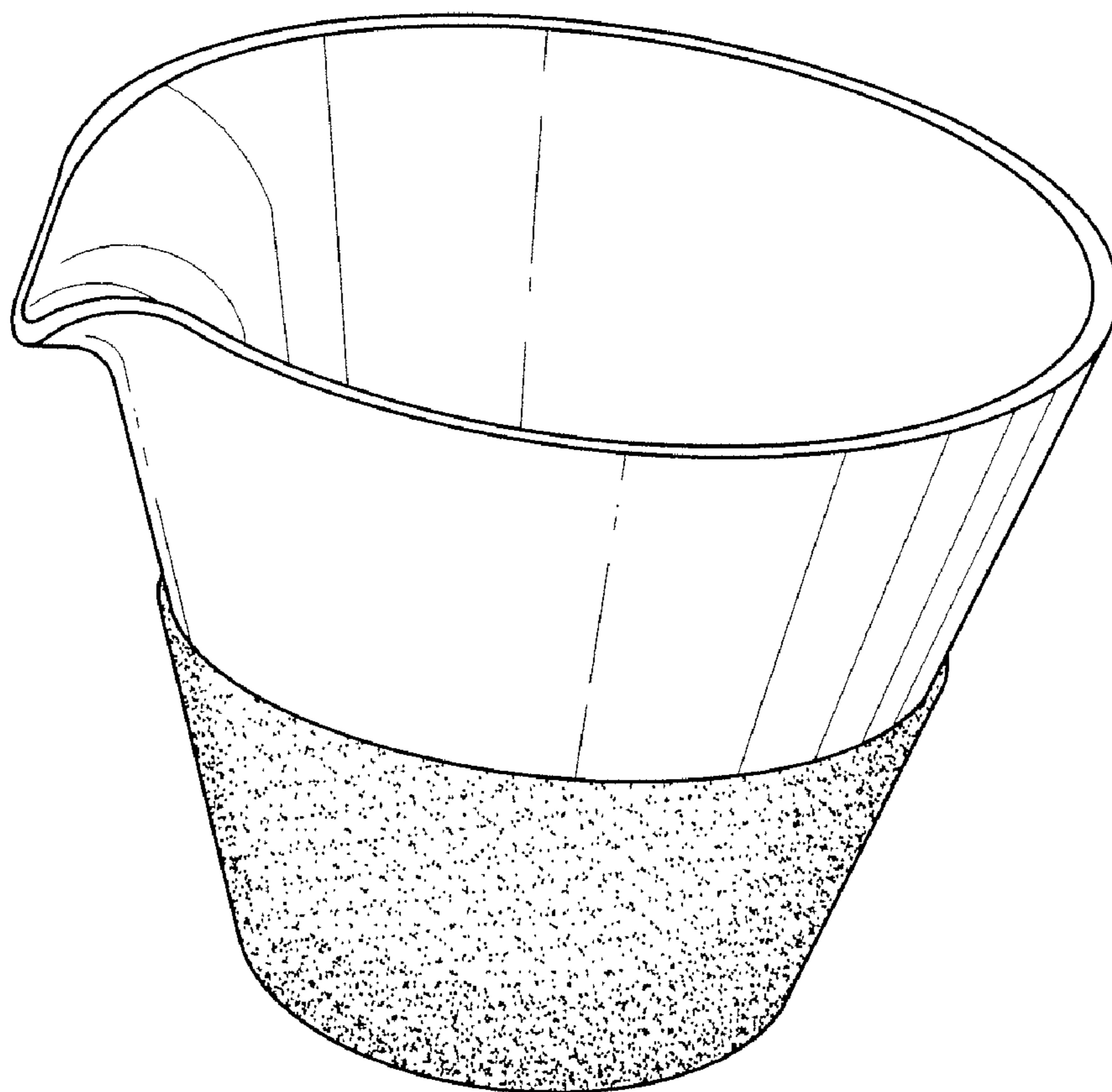

FIG. 2

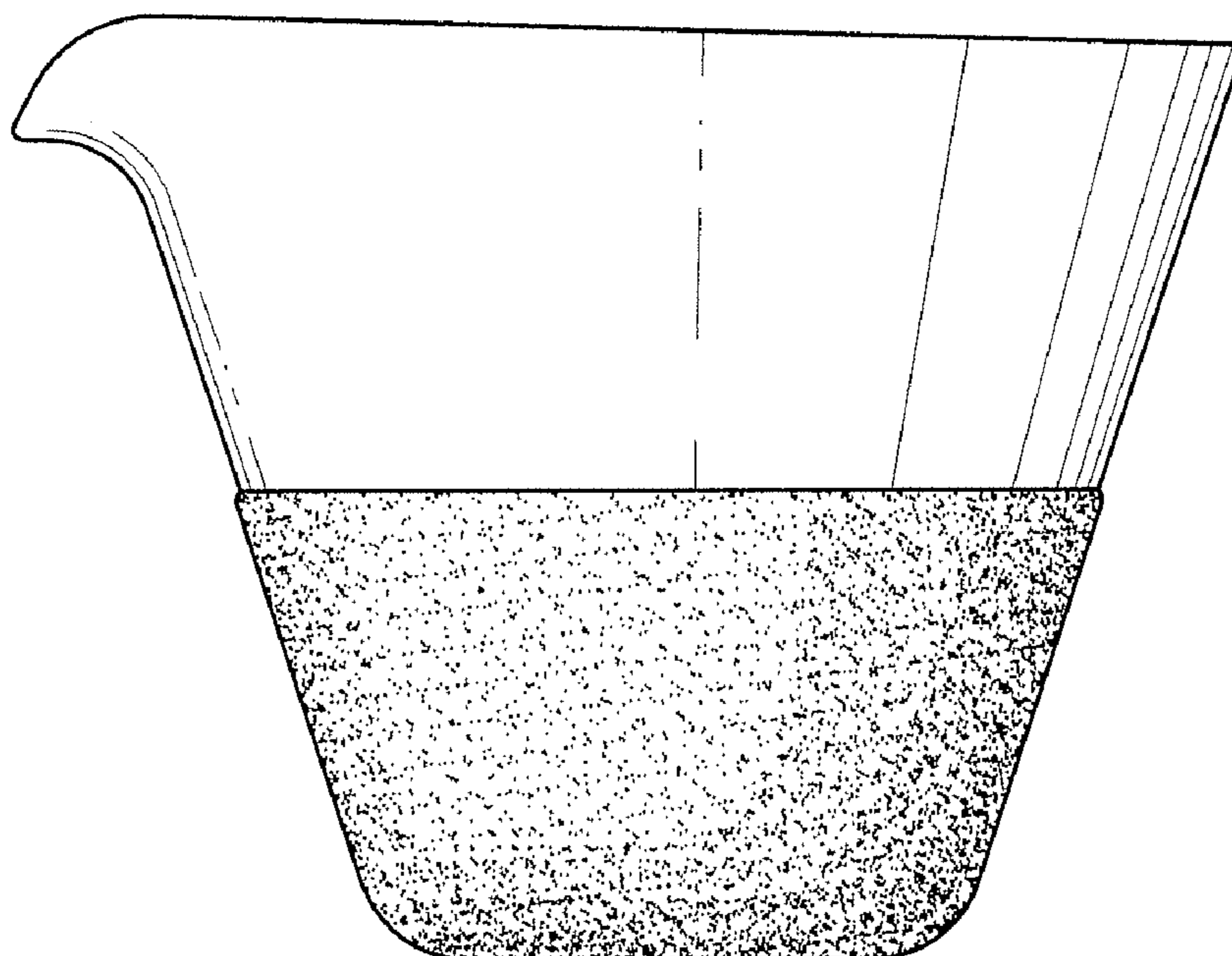

FIG. 3

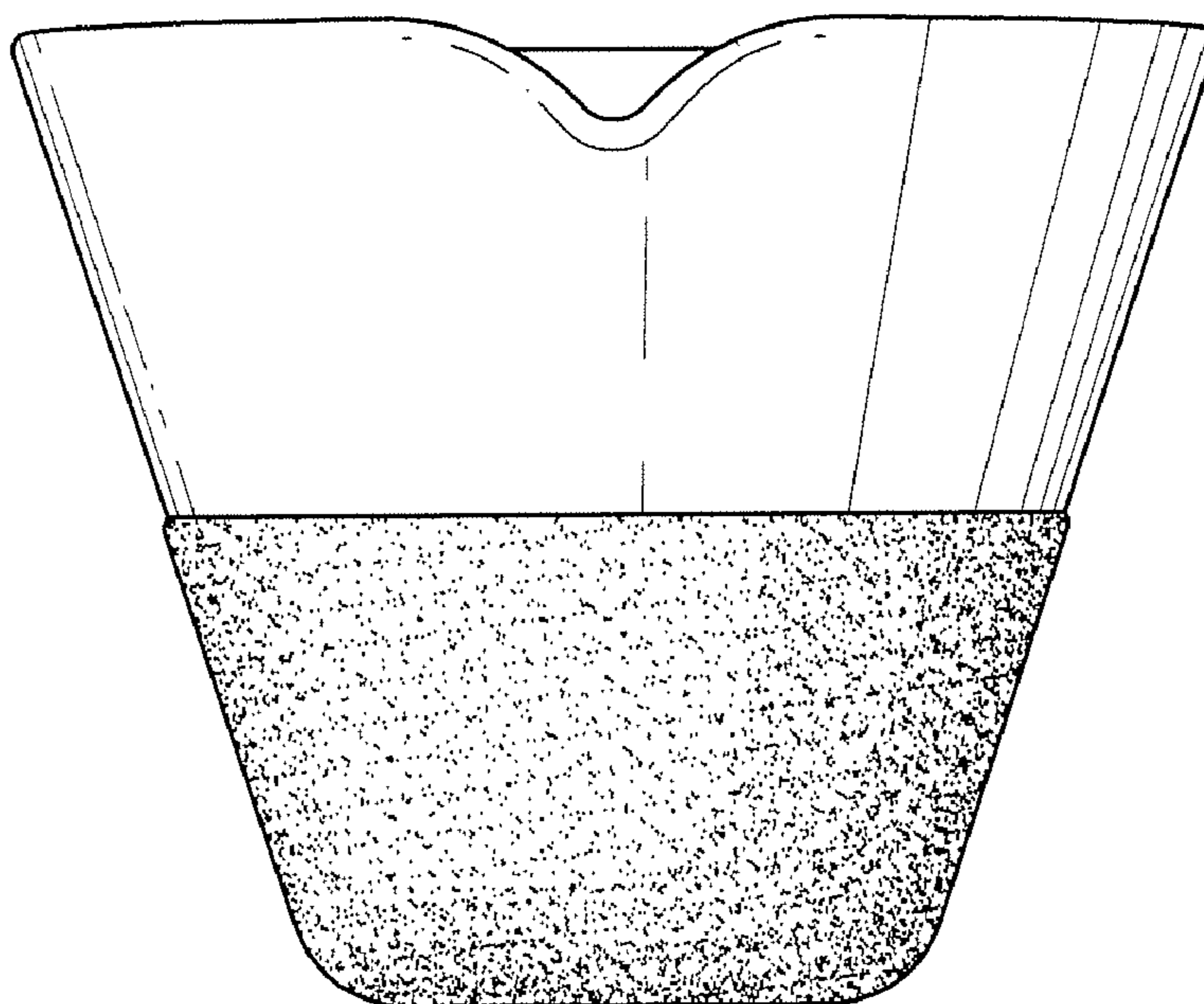

FIG. 4

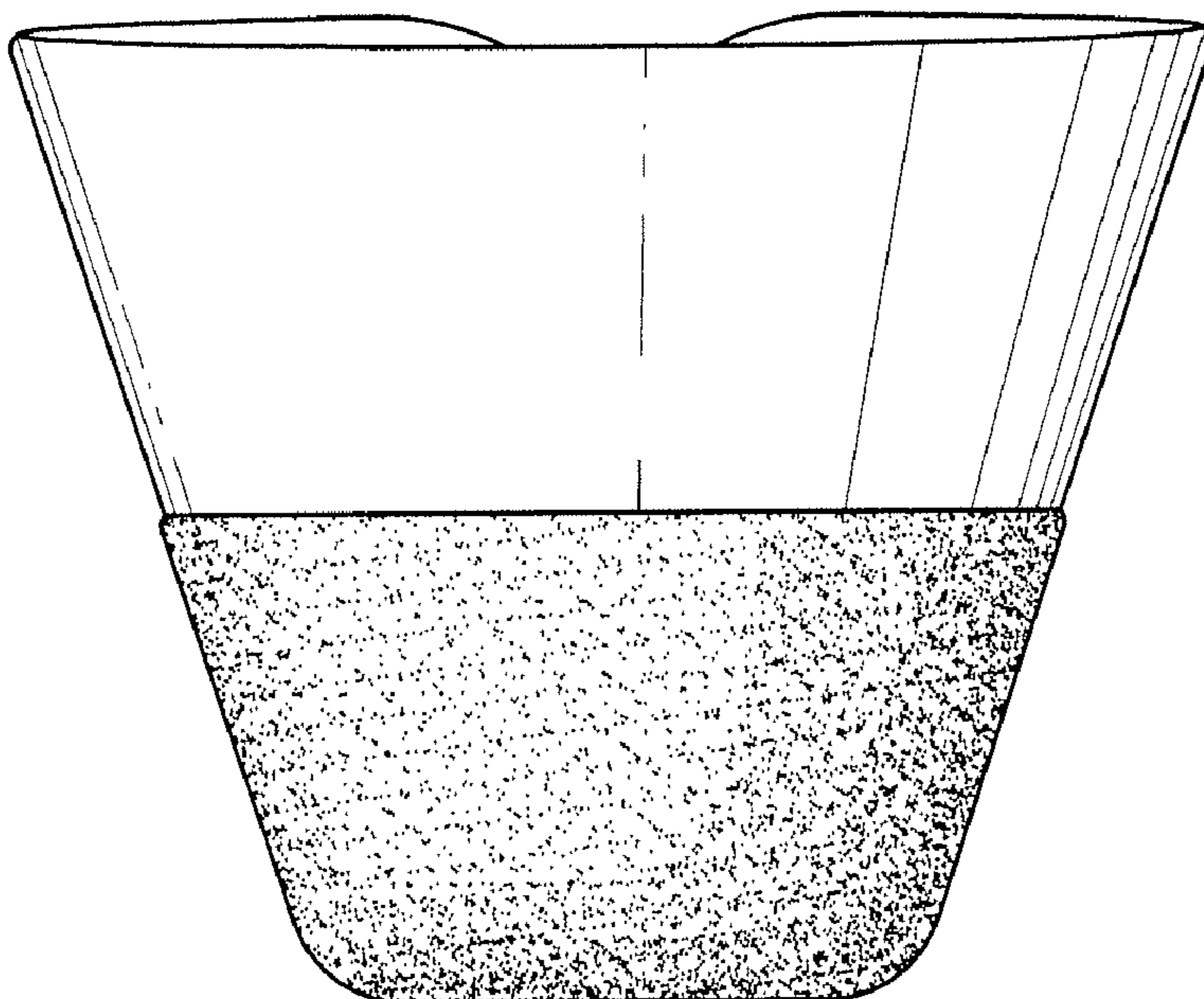

FIG. 5

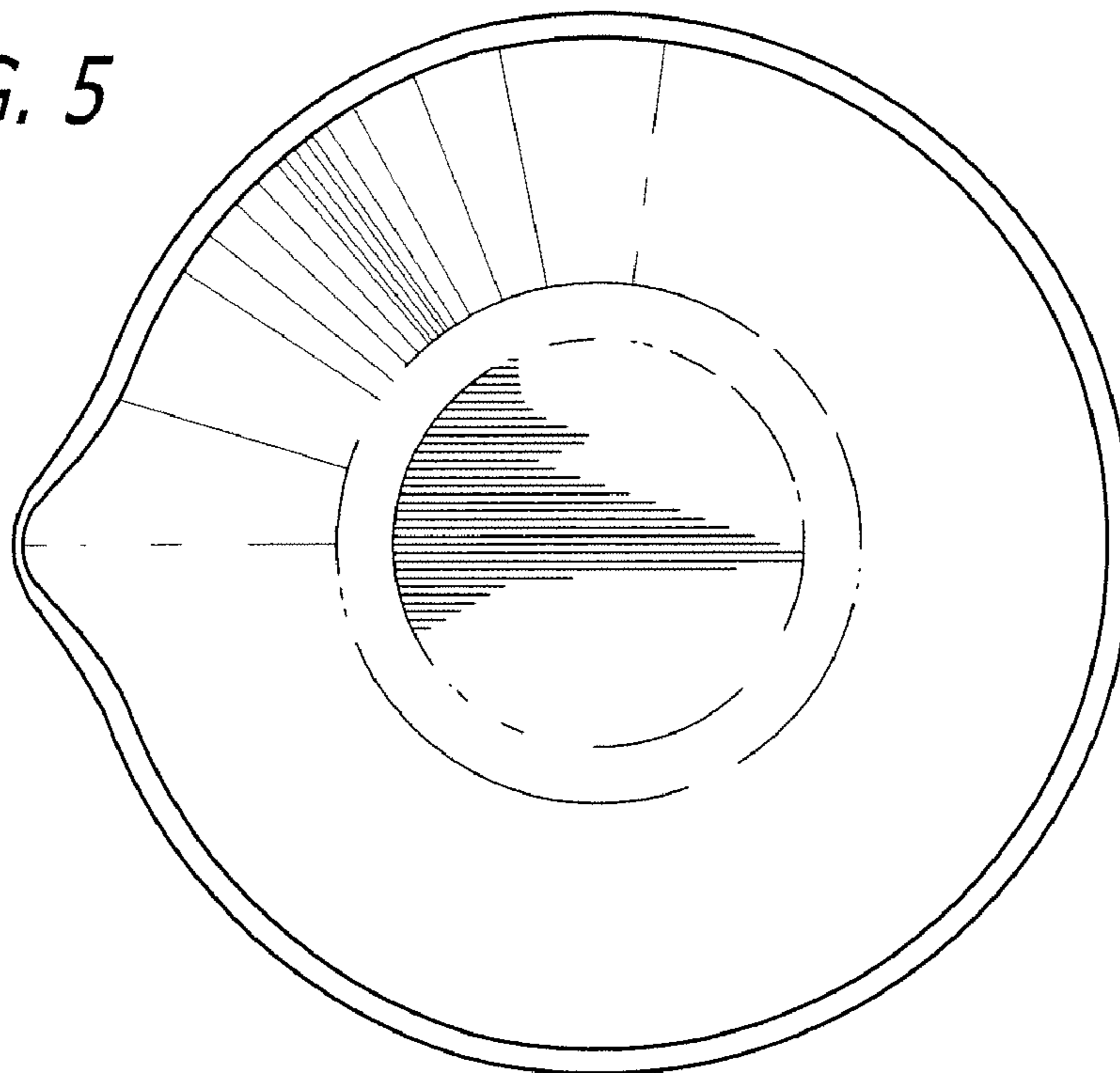

FIG. 6

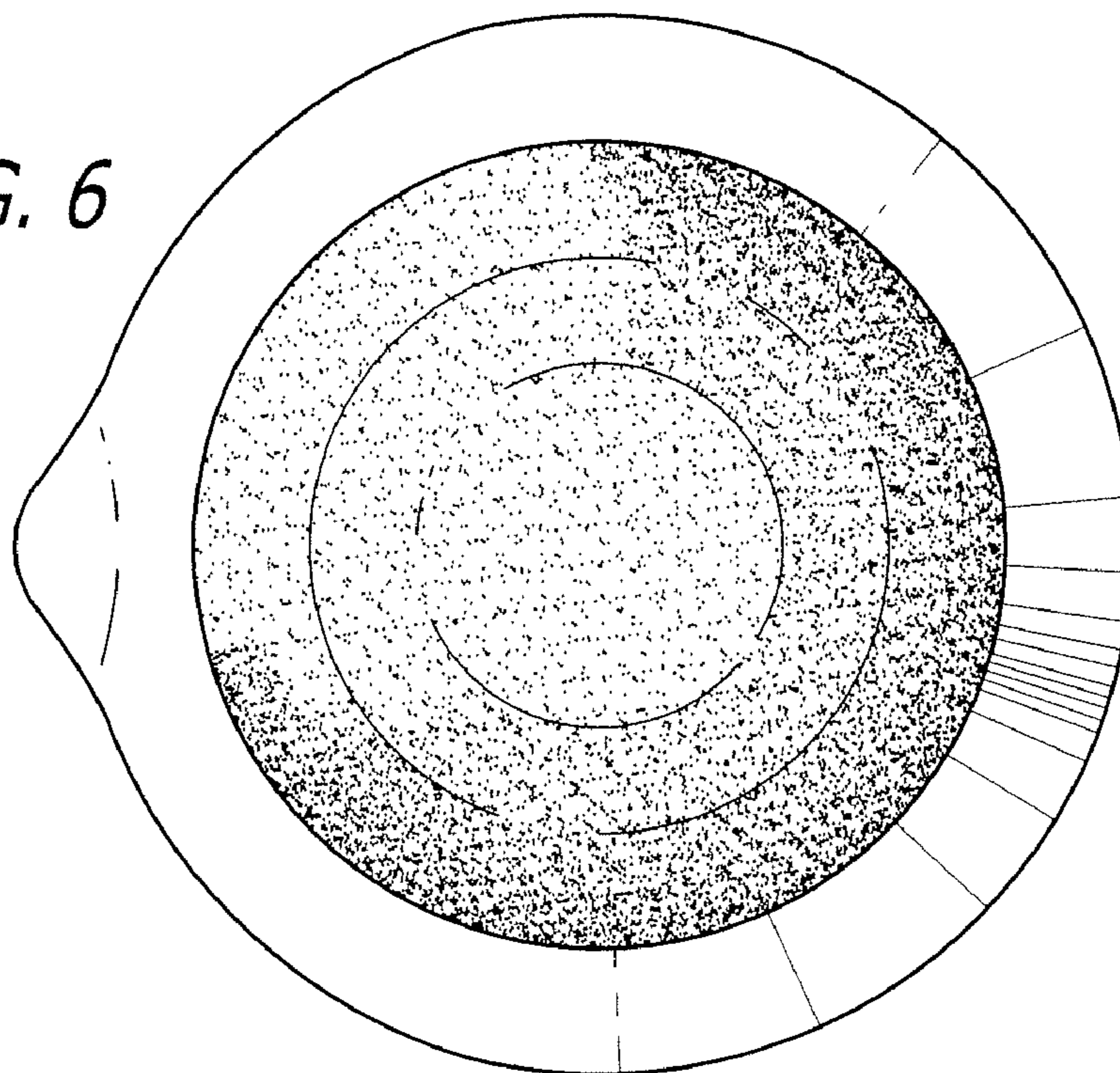

FIG. 7

