



US00D620707S

(12) **United States Design Patent**
Mogil

(10) **Patent No.:** **US D620,707 S**

(45) **Date of Patent:** **** Aug. 3, 2010**

(54) **FOLDABLE BAG**

(75) Inventor: **Melvin S. Mogil**, Toronto (CA)

(73) Assignee: **California Innovations Inc.** (CA)

(**) Term: **14 Years**

(21) Appl. No.: **29/356,276**

(22) Filed: **Feb. 23, 2010**

Related U.S. Application Data

(63) Continuation of application No. 10/340,851, filed on Jan. 13, 2003, now Pat. No. 7,682,080.

(51) **LOC (9) Cl.** **03-01**

(52) **U.S. Cl.** **D3/246**

(58) **Field of Classification Search** None
See application file for complete search history.

(56) **References Cited**

U.S. PATENT DOCUMENTS

1,666,704	A	4/1928	Hunter
1,672,322	A	6/1928	Keiser et al.
1,826,646	A	10/1931	Blake
1,985,111	A	12/1934	Shofer et al.
2,042,288	A	5/1936	Bach et al.
2,457,422	A	12/1948	Warner
3,437,181	A	4/1969	Blount, Jr.
3,682,372	A	8/1972	Rodley
3,831,650	A	8/1974	Consorti
4,091,852	A	5/1978	Jordan et al.
4,211,091	A	7/1980	Campbell
4,334,601	A	6/1982	Davis
4,499,999	A	2/1985	Behar
4,509,645	A	4/1985	Hotta
4,679,242	A	7/1987	Brockhaus
D291,150	S	8/1987	Beran
4,961,522	A	10/1990	Weber

(Continued)

FOREIGN PATENT DOCUMENTS

GB 2127678 A 4/1984

(Continued)

Primary Examiner—Holly H Baynham

(74) *Attorney, Agent, or Firm*—Ostrolenk Faber LLP

(57) **CLAIM**

The ornamental design for a foldable bag, as shown and described.

DESCRIPTION

FIG. 1 is a perspective view of a foldable bag showing my new design;

FIG. 2 is a perspective view thereof in a folded condition;

FIG. 3 is a front view thereof in a fully folded condition;

FIG. 4 is a rear view thereof;

FIG. 5 is a left end view thereof;

FIG. 6 is a right end view thereof;

FIG. 7 is a top view thereof;

FIG. 8 is a bottom view thereof;

FIG. 9 is a perspective view thereof in an unfolded condition;

FIG. 10 is a front view thereof;

FIG. 11 is a rear view thereof;

FIG. 12 is a left end view thereof;

FIG. 13 is a right end view thereof;

FIG. 14 is a top view thereof;

FIG. 15 is a bottom view thereof;

FIG. 16 is a front view thereof in a partially folded condition;

FIG. 17 is a rear view thereof;

FIG. 18 is a left end view thereof; and,

FIG. 19 is a right end view thereof.

The broken lines showing is of environmental material and form no part of the claimed design.

1 Claim, 11 Drawing Sheets



US D620,707 S

Page 2

U.S. PATENT DOCUMENTS

4,974,966 A	12/1990	Fabbi	5,904,230 A	5/1999	Peterson
4,984,662 A	1/1991	Jacober	5,957,354 A	9/1999	Mentken
5,090,526 A	2/1992	Jacober	5,964,384 A	10/1999	Young
D328,550 S	8/1992	Mogil et al.	6,068,402 A	5/2000	Freese et al.
5,158,371 A	10/1992	Moravek	D431,968 S	10/2000	Worley et al.
5,353,900 A	10/1994	Stilley	D432,870 S	10/2000	Worley et al.
5,472,279 A	12/1995	Lin	6,234,677 B1	5/2001	Mogil
5,490,396 A	2/1996	Morris	6,247,328 B1	6/2001	Mogil
5,562,228 A	10/1996	Ericson	D452,075 S	12/2001	Mogil
5,567,055 A	10/1996	Smith	6,332,712 B1	12/2001	Headley
D382,771 S	8/1997	Mogil	6,582,124 B2	6/2003	Mogil
D382,772 S	8/1997	Mogil	D587,010 S *	2/2009	Deck D3/246
D387,249 S	12/1997	Mogil			
D391,121 S	2/1998	Melk			
5,857,778 A	1/1999	Ells			

FOREIGN PATENT DOCUMENTS

WO WO 92/09219 A1 6/1992

* cited by examiner

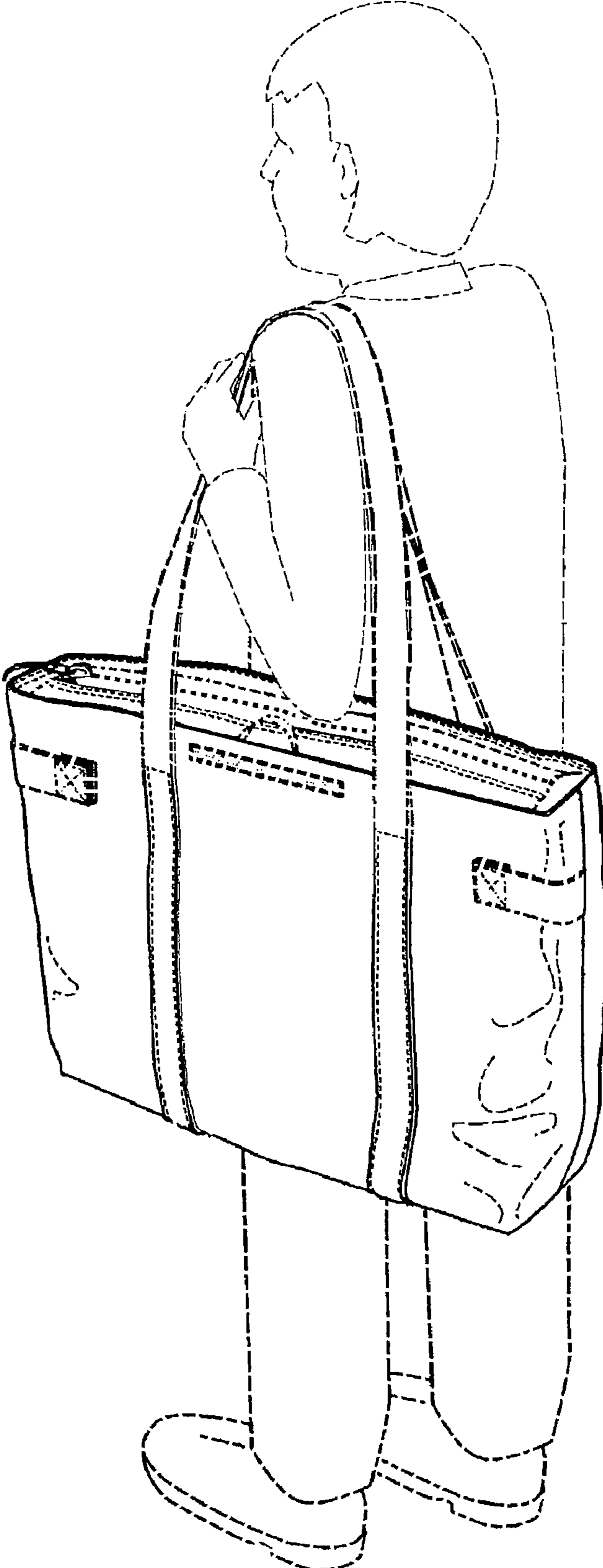

FIG. 1

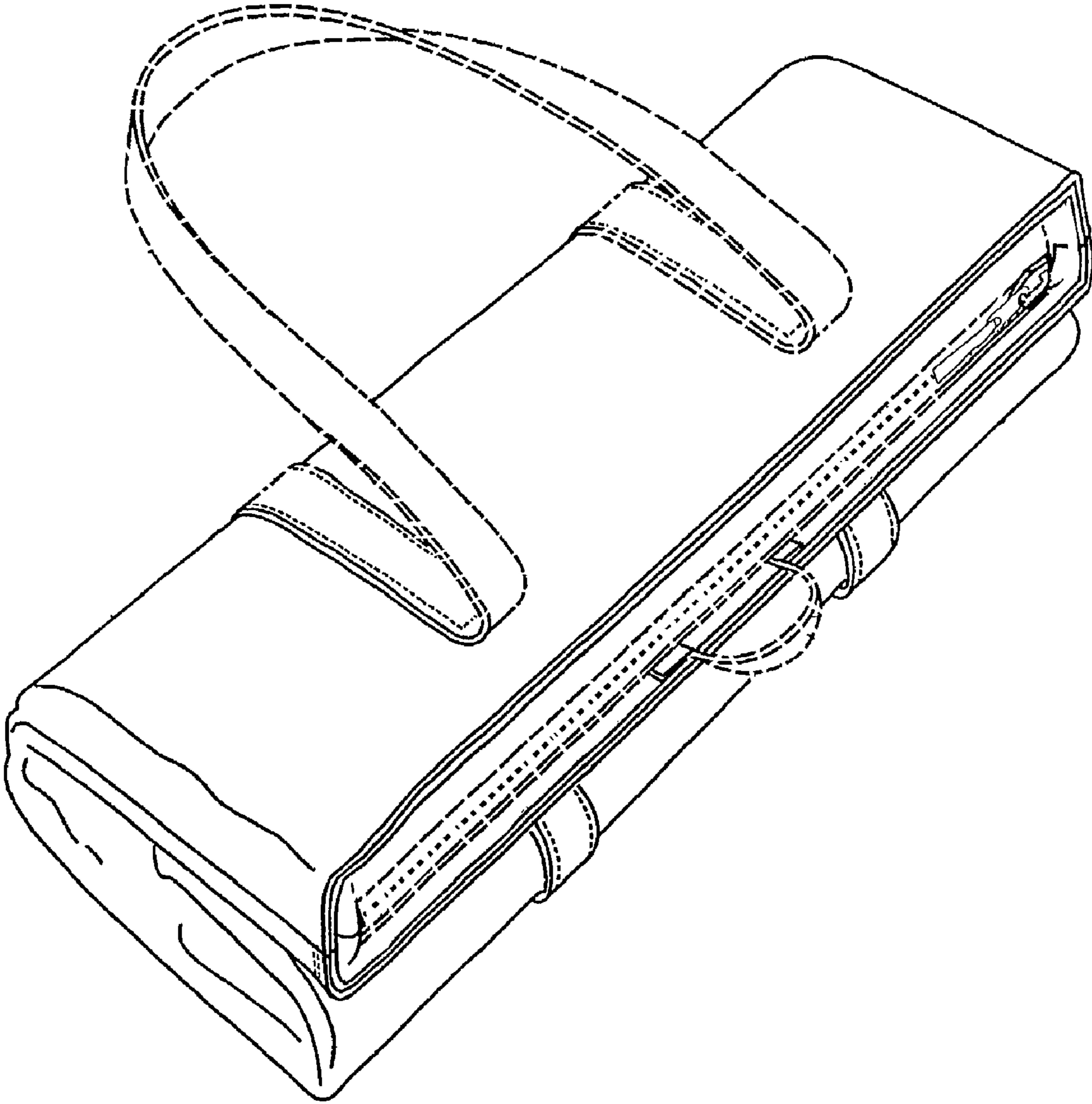

FIG. 2

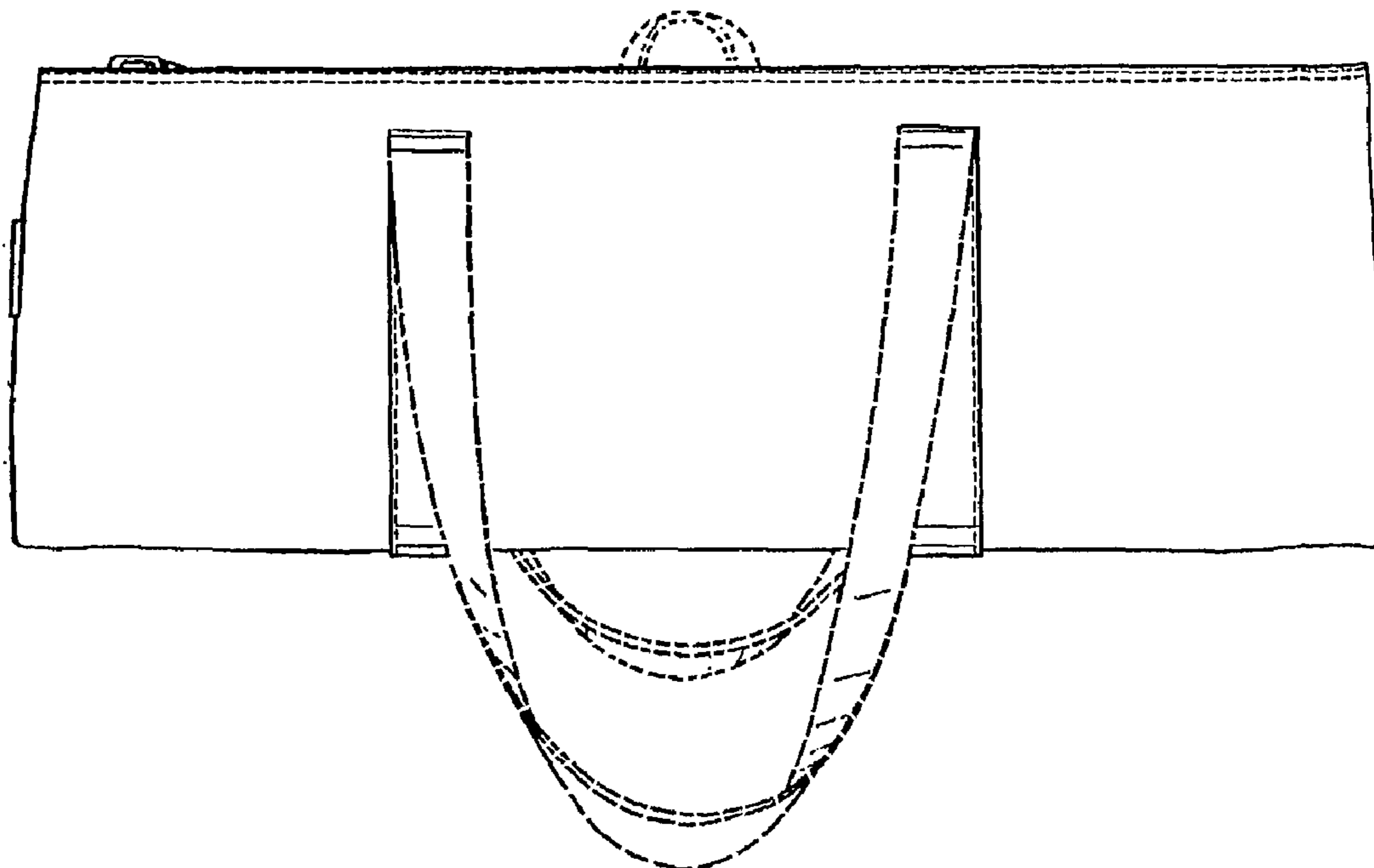

FIG. 3

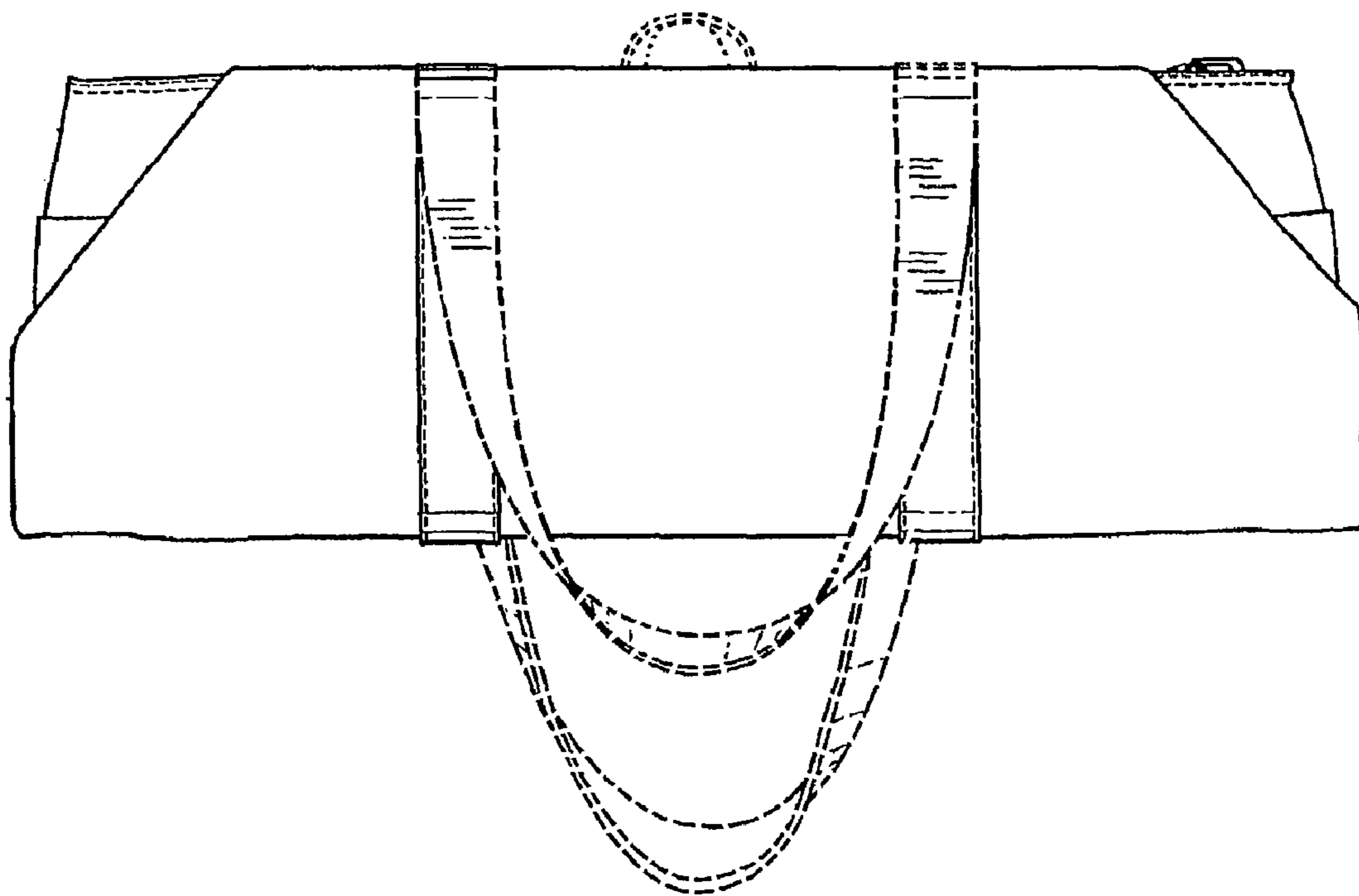

FIG. 4

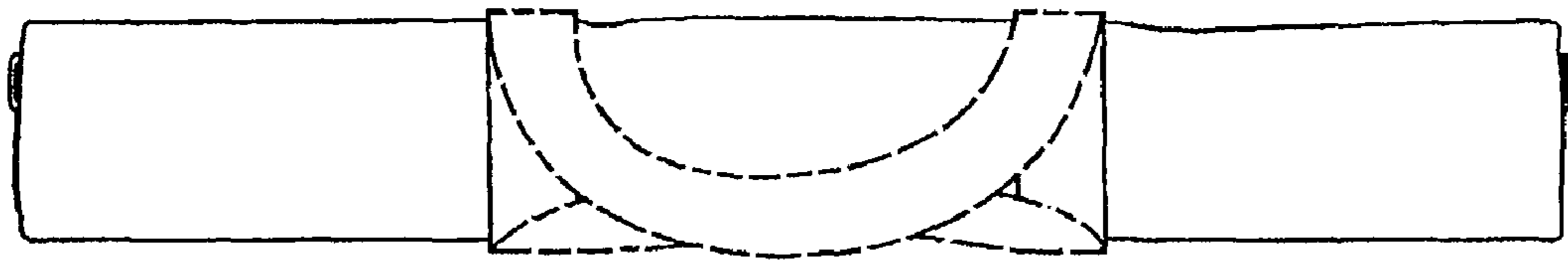

FIG. 8

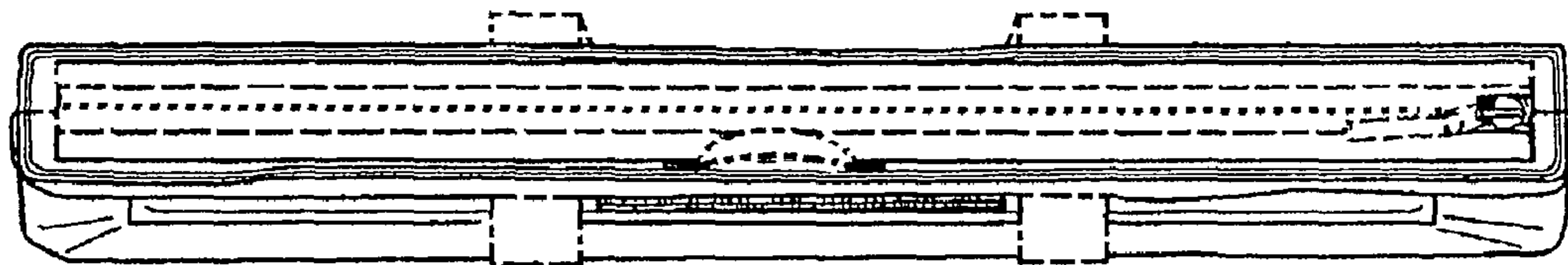

FIG. 7

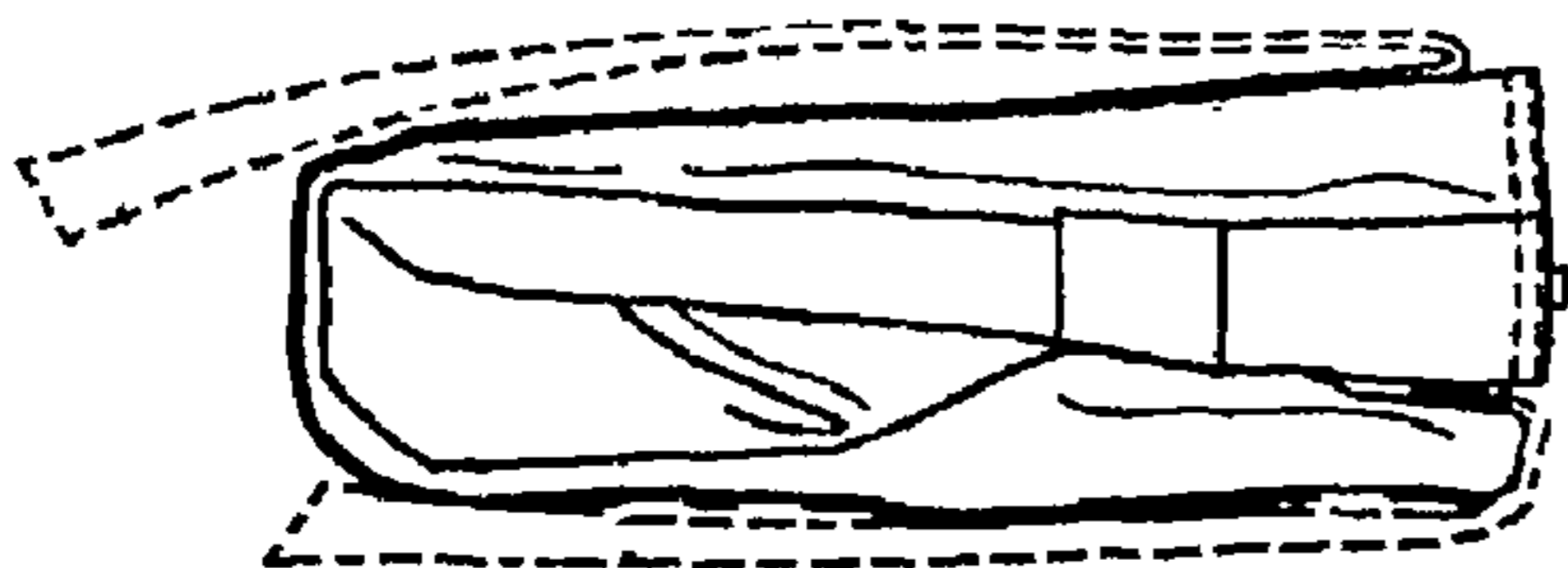

FIG. 6

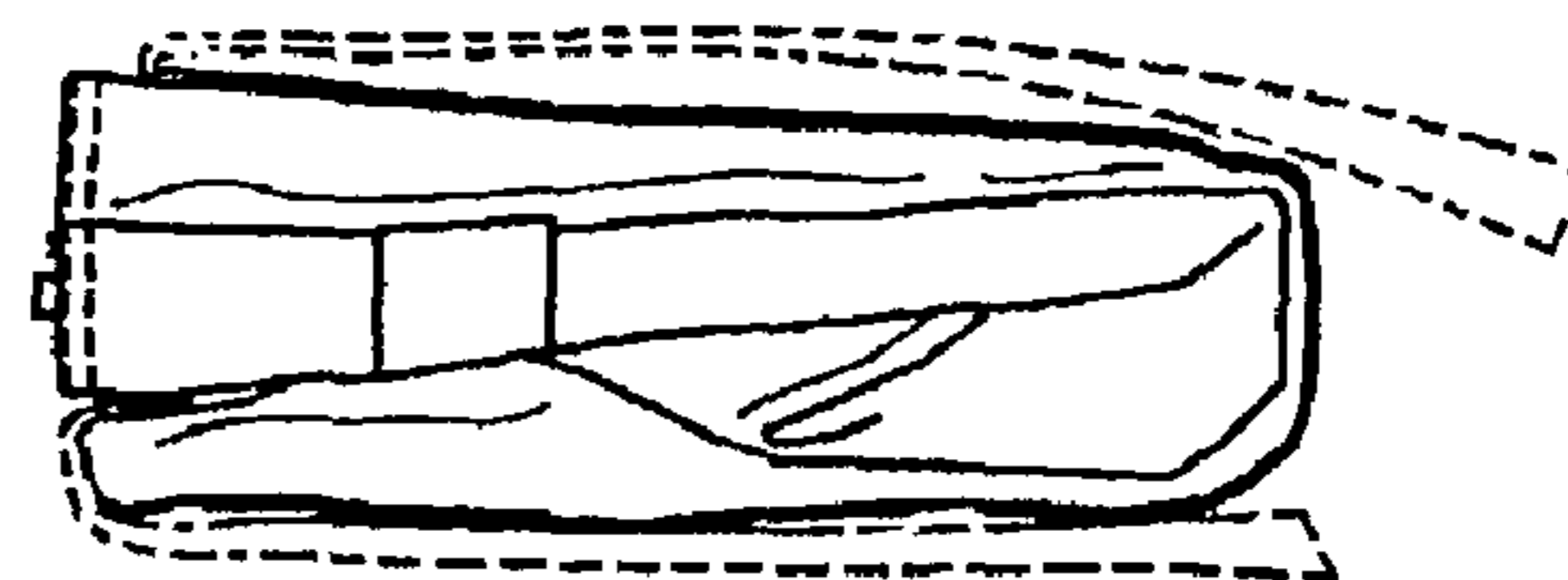

FIG. 5

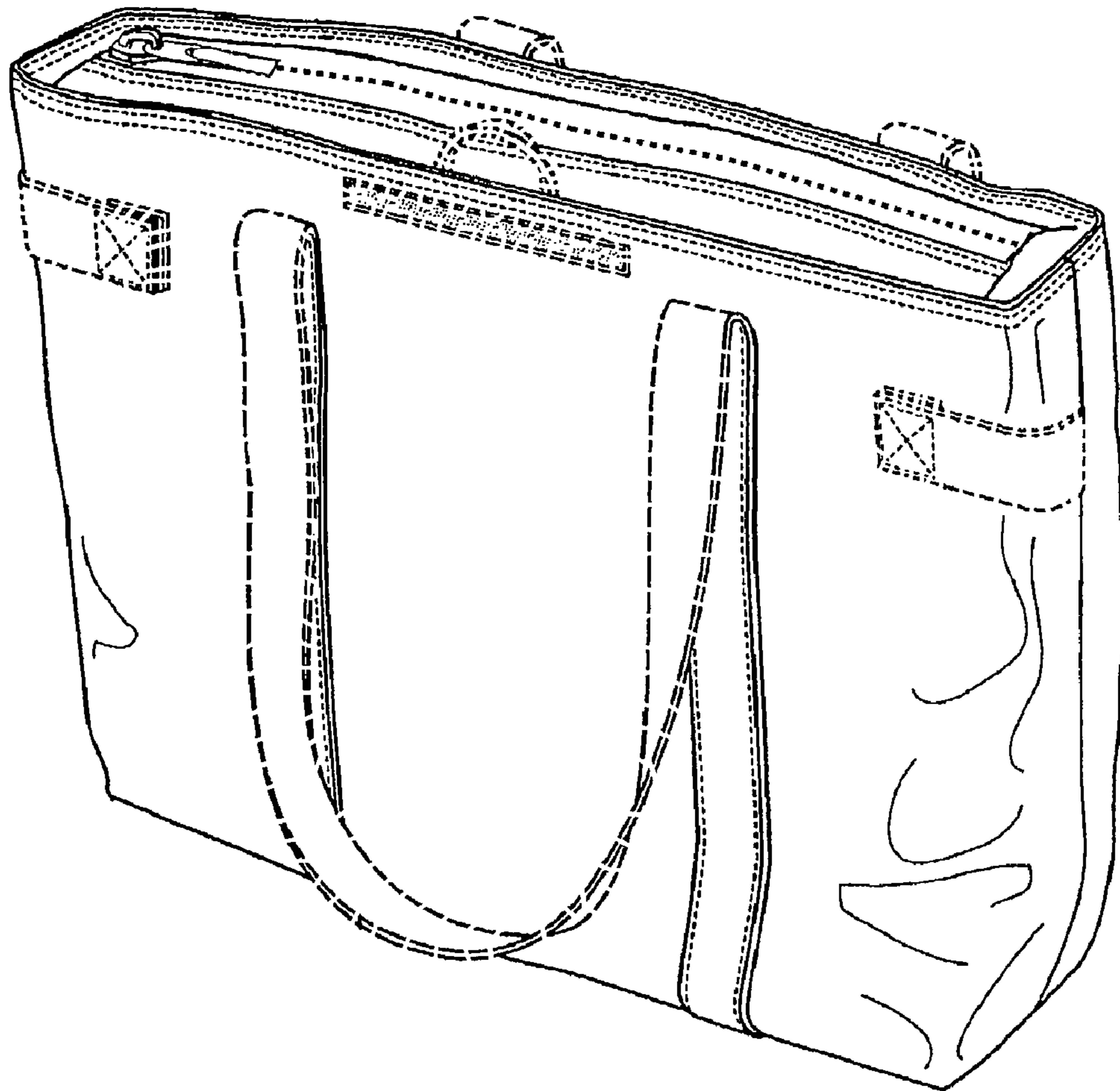

FIG. 9

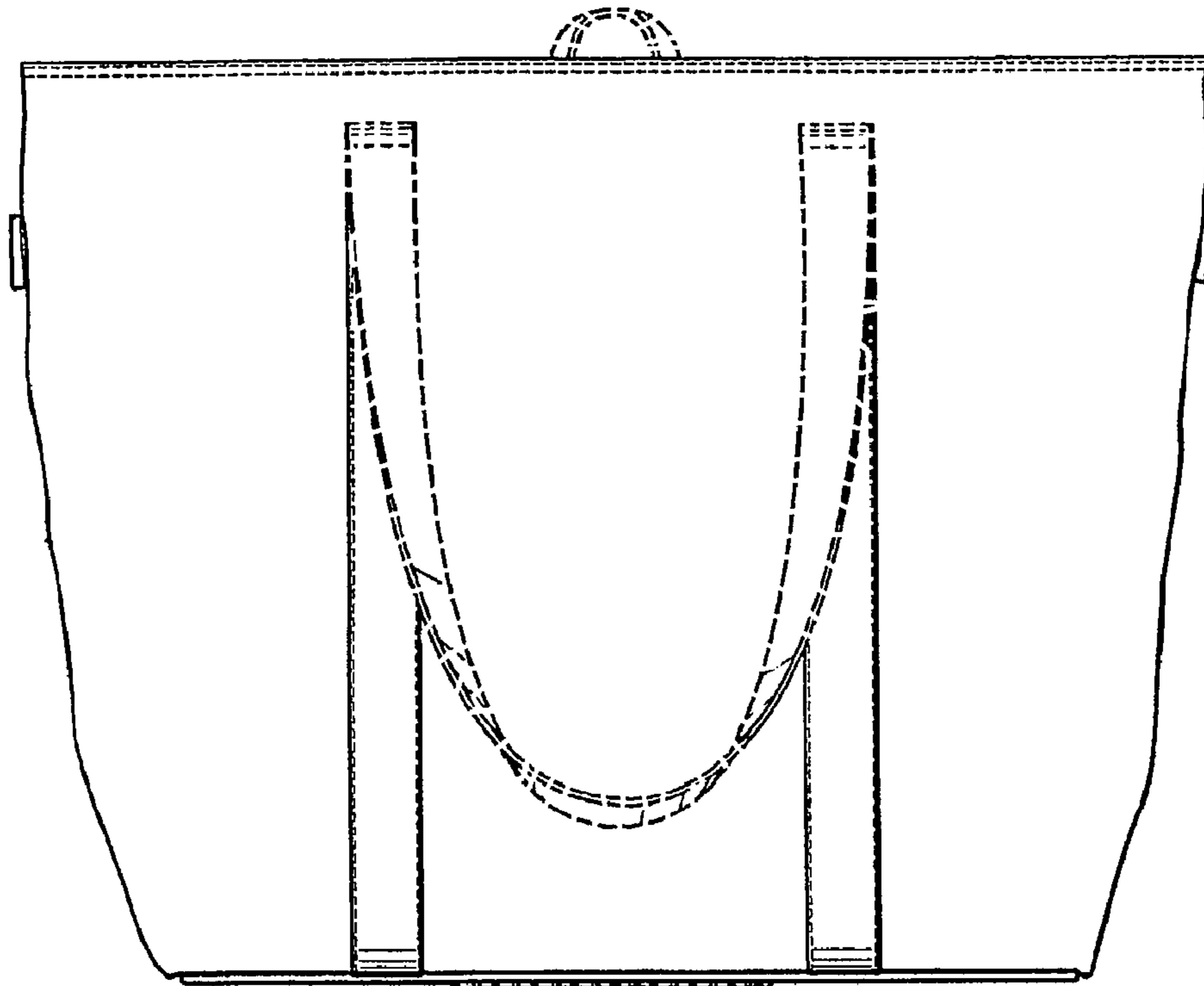

FIG. 10

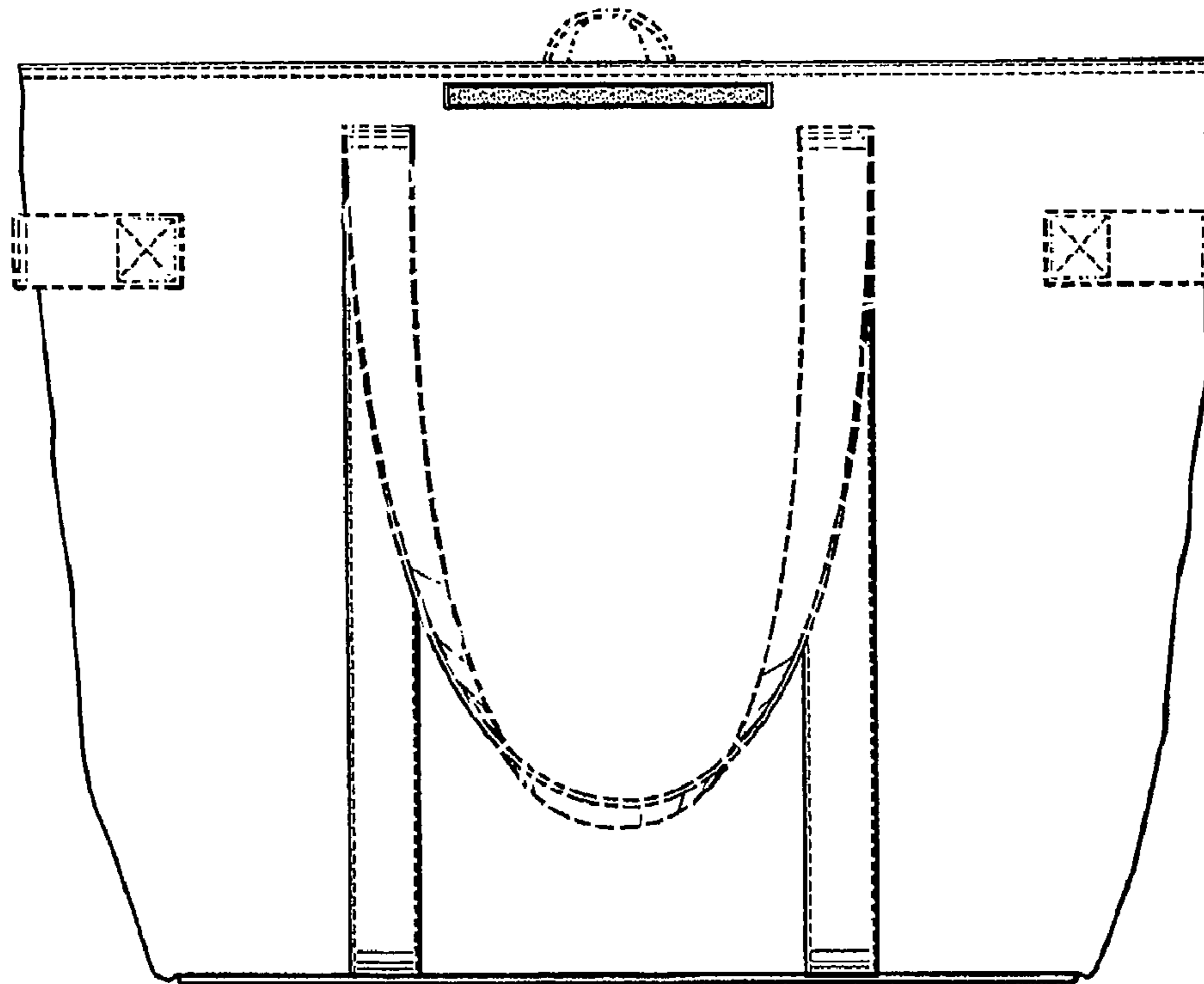

FIG. 11

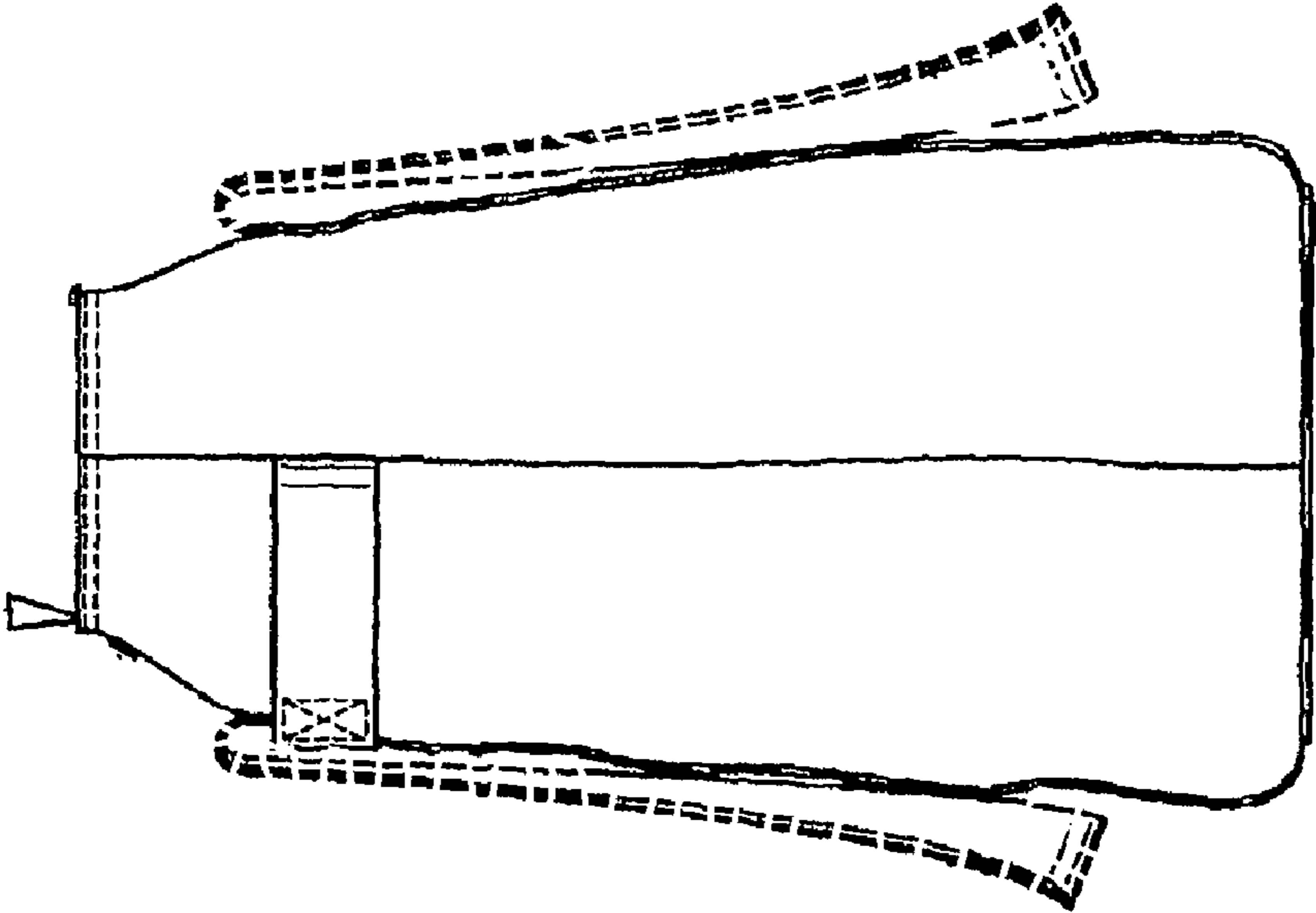

FIG. 12

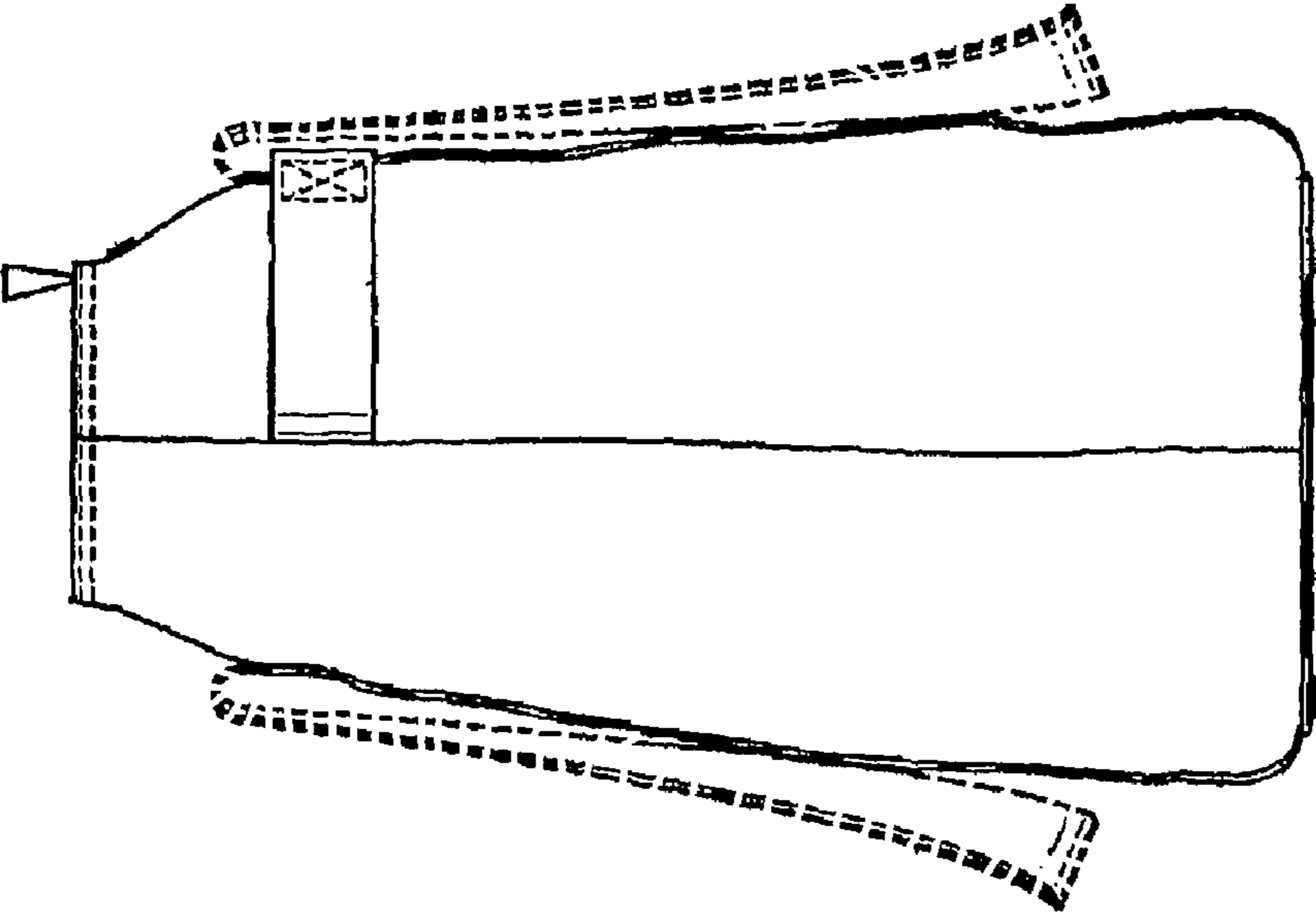

FIG. 13

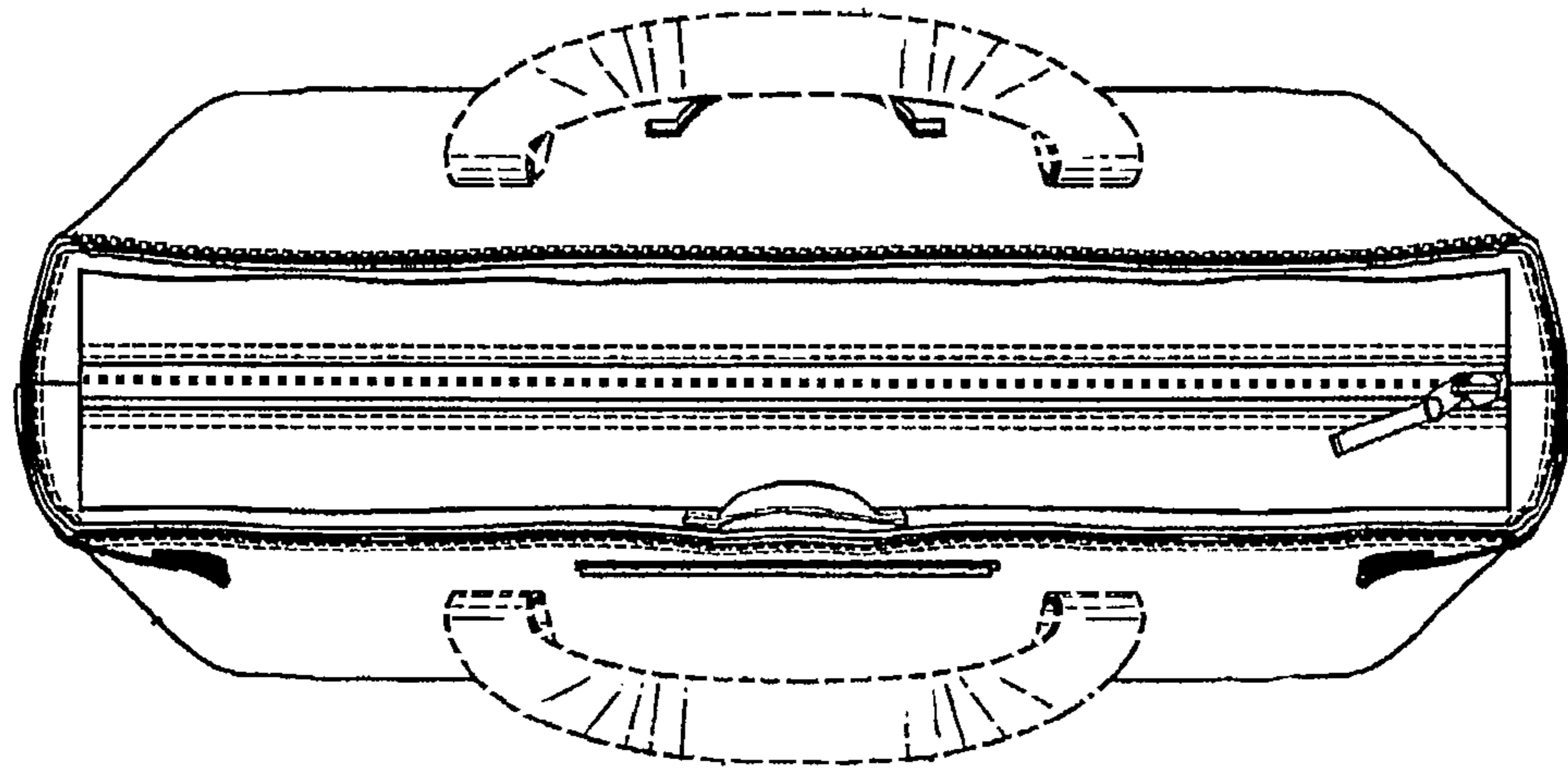

FIG. 14

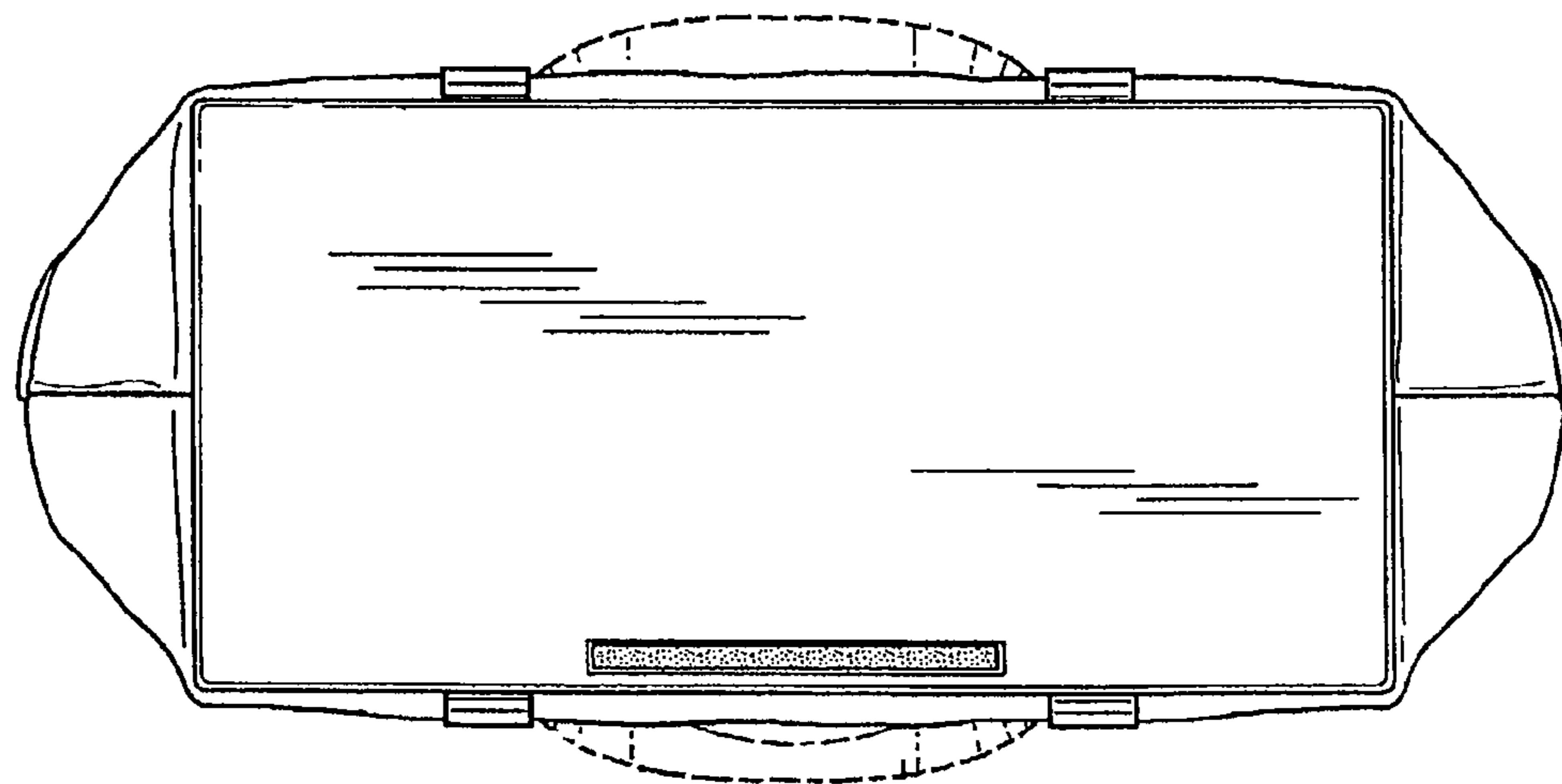

FIG. 15

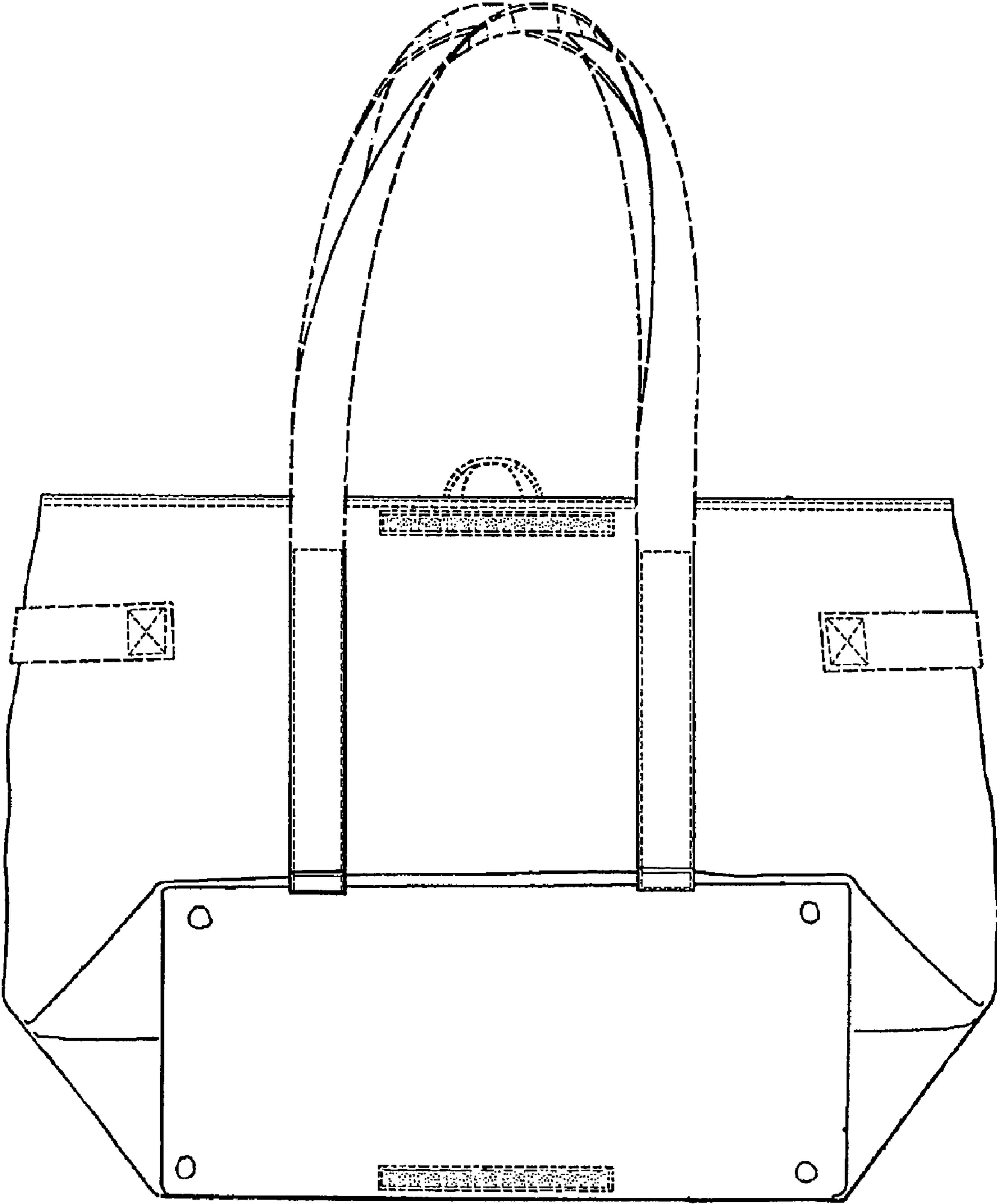

FIG. 16

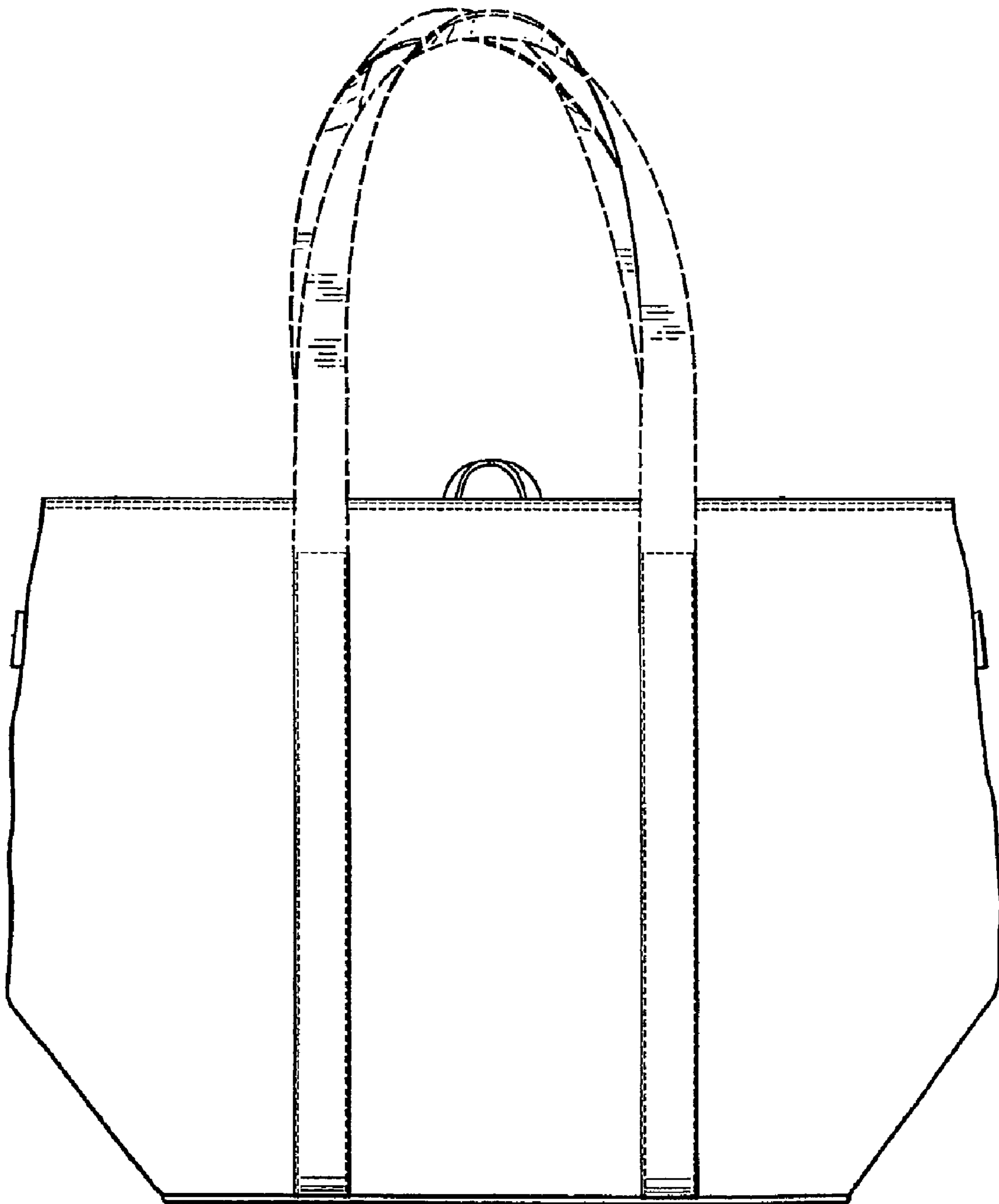

FIG. 17

FIG. 19

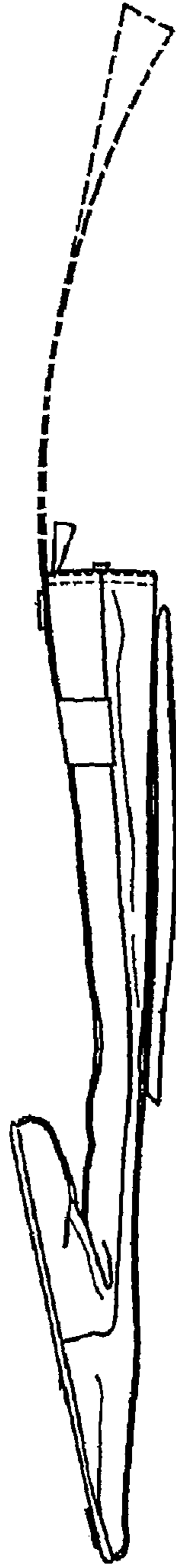

FIG. 18

