



US00D620634S

(12) **United States Design Patent**
Komar et al.

(10) **Patent No.:** **US D620,634 S**
(45) **Date of Patent:** **** Jul. 27, 2010**

(54) **LUMINAIRE ASSEMBLY**

- (75) Inventors: **Jürgen Komar**, Rott Am Inn (DE);
Florian Wildner, Munich (DE)
- (73) Assignee: **OSRAM Gesellschaft mit
beschränkter Haftung**, Munich (DE)
- (**) Term: **14 Years**
- (21) Appl. No.: **29/341,984**
- (22) Filed: **Aug. 17, 2009**
- (30) **Foreign Application Priority Data**

Feb. 18, 2009 (EM) 001097646

- (51) **LOC (9) Cl.** **26-03**
- (52) **U.S. Cl.** **D26/93**
- (58) **Field of Classification Search** D26/1,
D26/24, 63, 67, 93-94, 104-110; 362/3,
362/153, 186, 217, 225, 235, 25, 257, 277,
362/317, 351, 353, 362, 363, 382, 431, 433,
362/458

See application file for complete search history.

(56) **References Cited**

U.S. PATENT DOCUMENTS

D280,025	S	*	8/1985	Waters	D26/24
5,001,614	A	*	3/1991	Buss	362/225
D317,364	S	*	6/1991	Cross	D26/93
D370,072	S	*	5/1996	Arden	D26/93
D374,737	S	*	10/1996	Can	D26/80
D477,093	S	*	7/2003	Moriyama et al.	D26/3
6,682,205	B2	*	1/2004	Lin	362/235
D513,082	S	*	12/2005	Hoshikawa et al.	D26/1
D531,139	S	*	10/2006	Egawa et al.	D26/93
D536,110	S	*	1/2007	Wright	D26/24
D573,730	S	*	7/2008	Uemoto et al.	D26/24
D581,571	S	*	11/2008	Levine	D26/63
D594,588	S	*	6/2009	Fanning	D26/93

* cited by examiner

Primary Examiner—Brian N Vinson

(57) **CLAIM**

The ornamental design for a luminaire assembly, as shown and described.

DESCRIPTION

- FIG. 1 is a perspective front right side view of the luminaire and the fixture of the luminaire assembly;
- FIG. 2 is a front view thereof;
- FIG. 3 is a right side view thereof;
- FIG. 4 is a back view thereof;
- FIG. 5 is a top view thereof;
- FIG. 6 is a left side view thereof;
- FIG. 7 is a bottom view thereof;
- FIG. 8 is a perspective front right side view of the luminaire assembly in which the luminaire is clamped in the fixture;
- FIG. 9 is a front view thereof;
- FIG. 10 is a right side view thereof;
- FIG. 11 is a back view thereof;
- FIG. 12 is a left side view thereof;
- FIG. 13 is a top view thereof;
- FIG. 14 is a bottom view thereof;
- FIG. 15 is a perspective front right side view of the luminaire assembly in which the luminaire is clamped in the fixture in an alternative position;
- FIG. 16 is a perspective front right side view of the luminaire assembly in which the luminaire is clamped in the fixture in a second alternative position;
- FIG. 17 is a front view of the luminaire assembly in which the luminaire is clamped in the fixture according to the position shown in FIG. 15;
- FIG. 18 is a left side view thereof;
- FIG. 19 is a back view thereof;
- FIG. 20 is a top view thereof; and,
- FIG. 21 is a bottom view thereof.

In an embodiment, the luminaire assembly includes a portable, cylindrical luminaire having four LEDs and a fixture for mounting the luminaire in a vertical or horizontal position. The fixture can be mounted to a seat by screws, by a magnet or by an adherend.

1 Claim, 21 Drawing Sheets

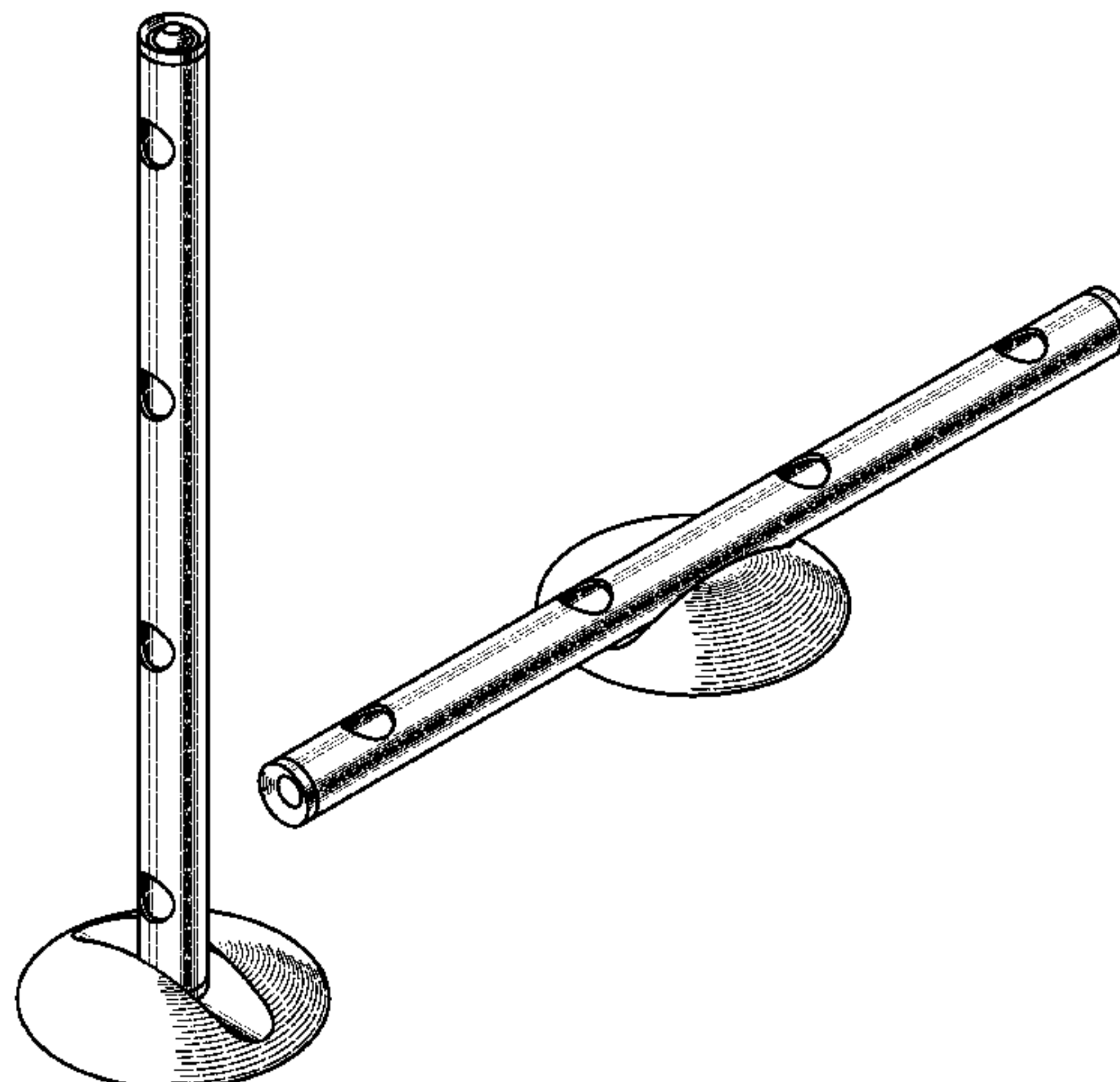

FIG 1

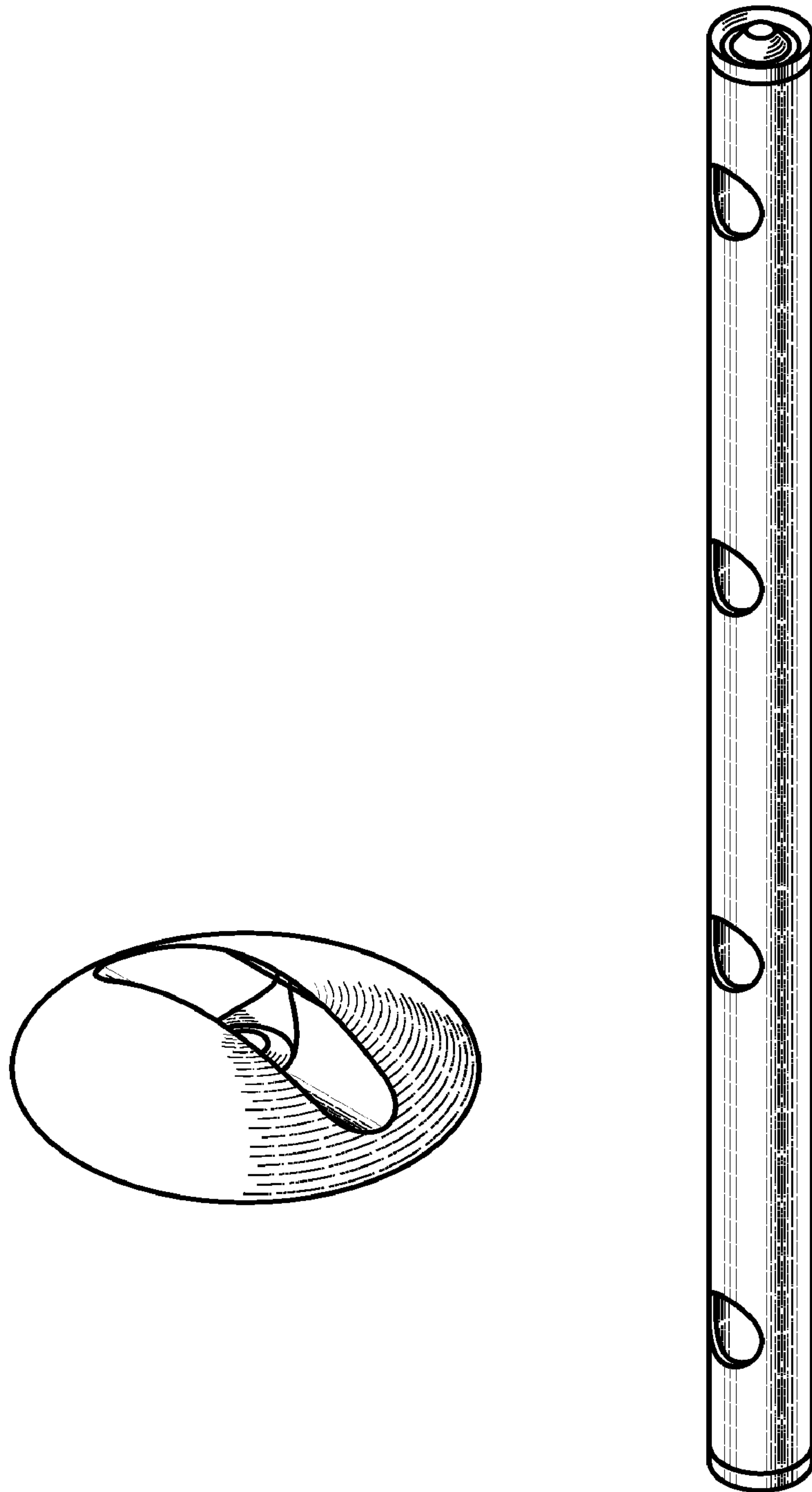

FIG 2

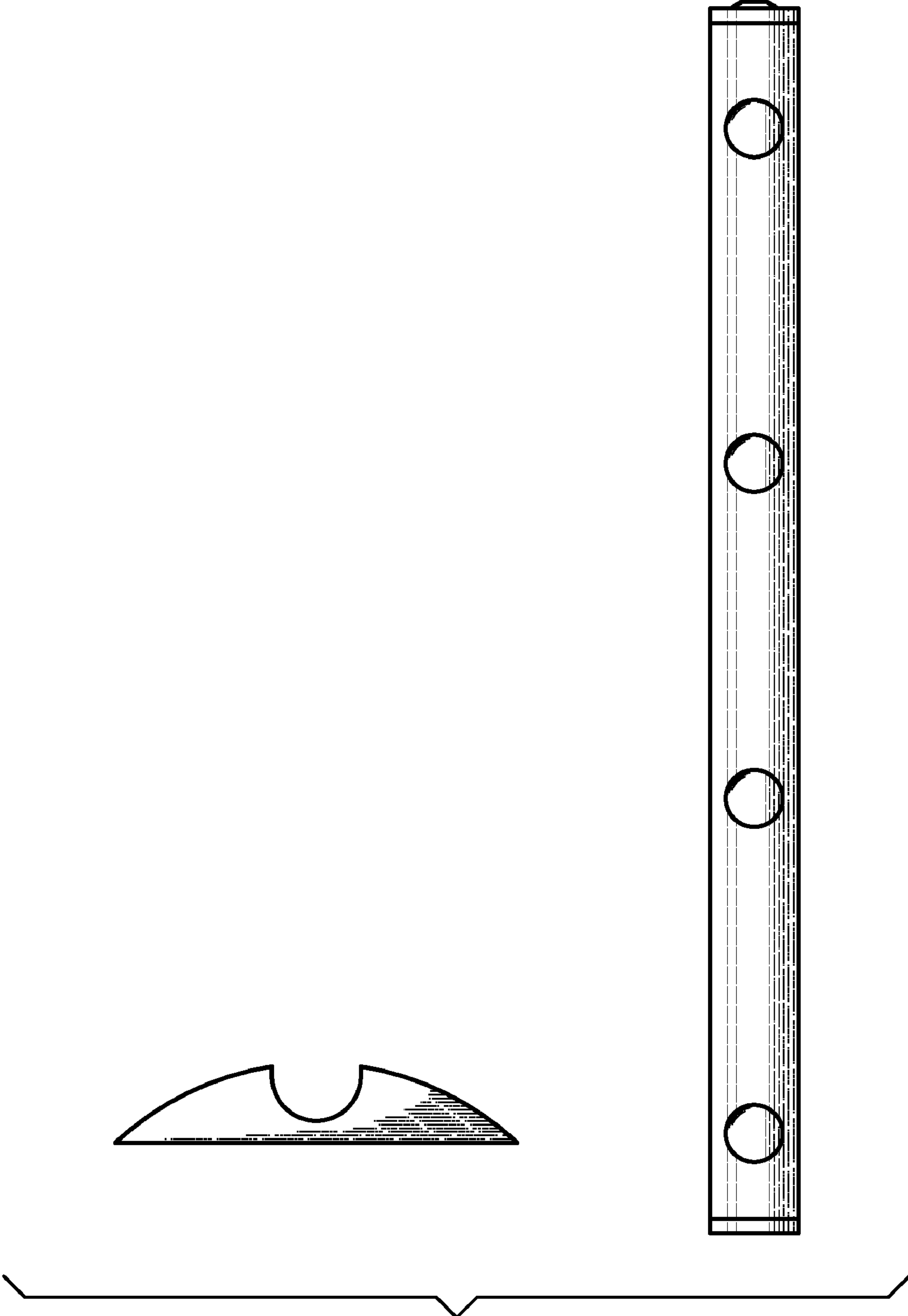

FIG 3

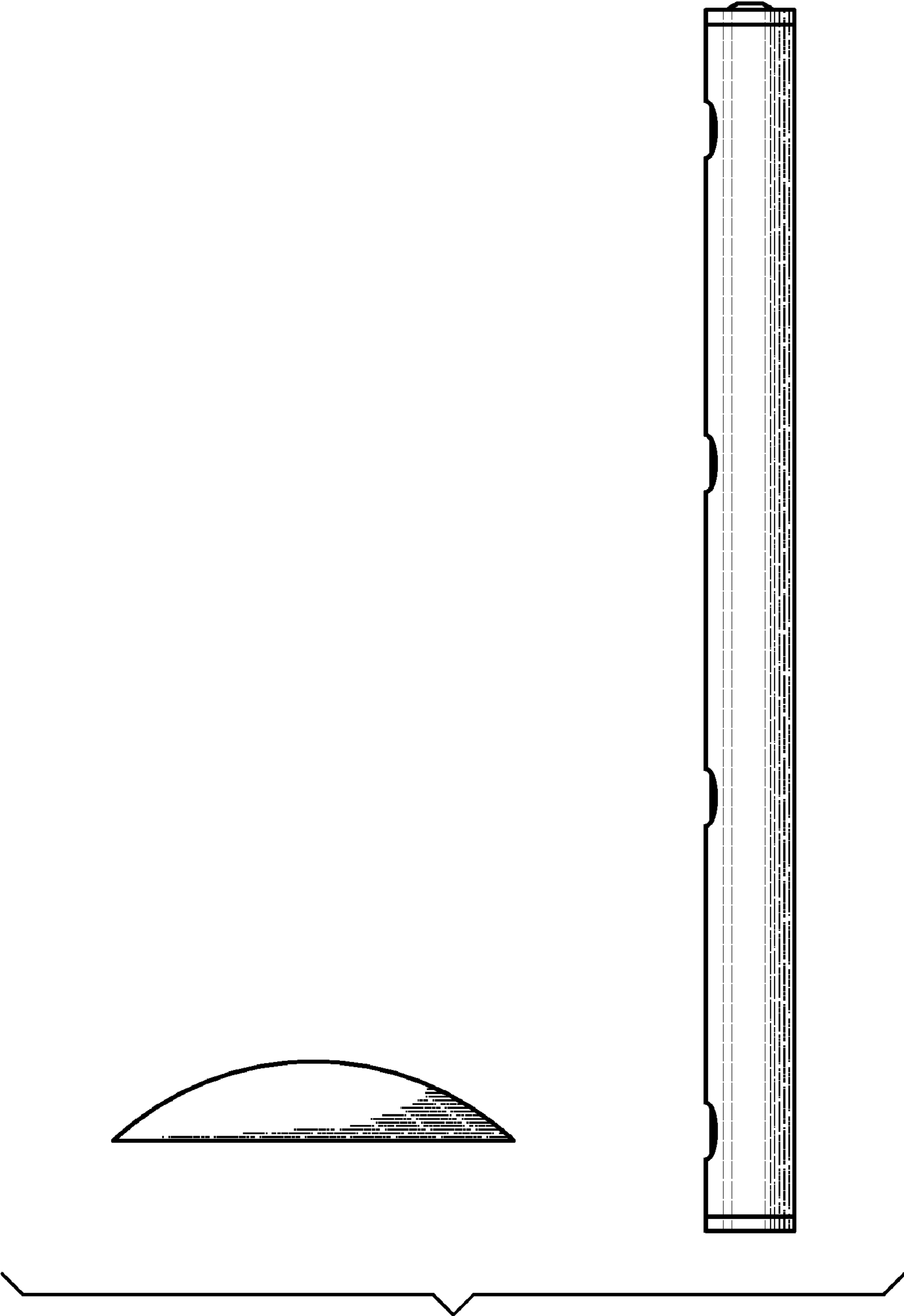

FIG 4

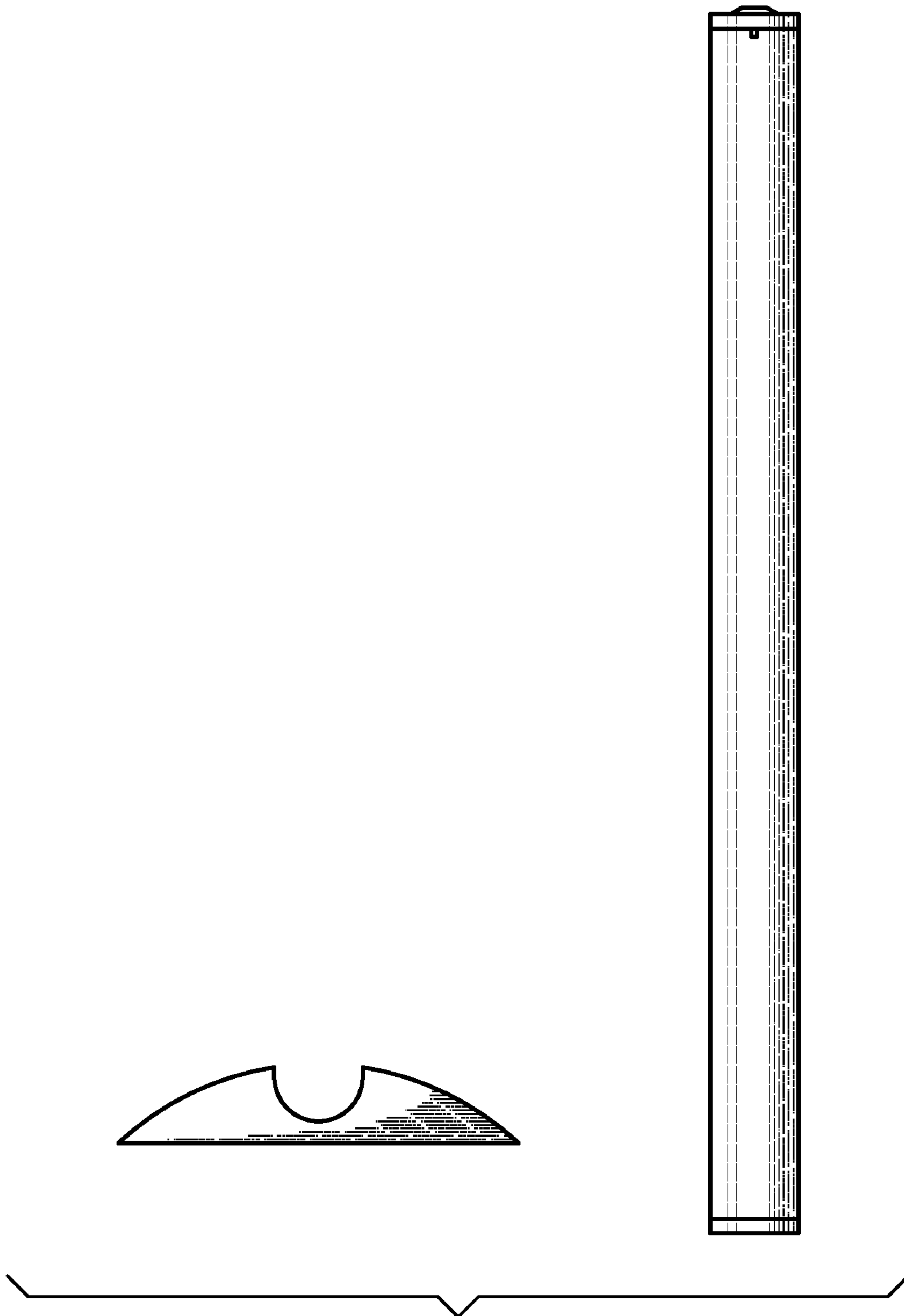

FIG 5

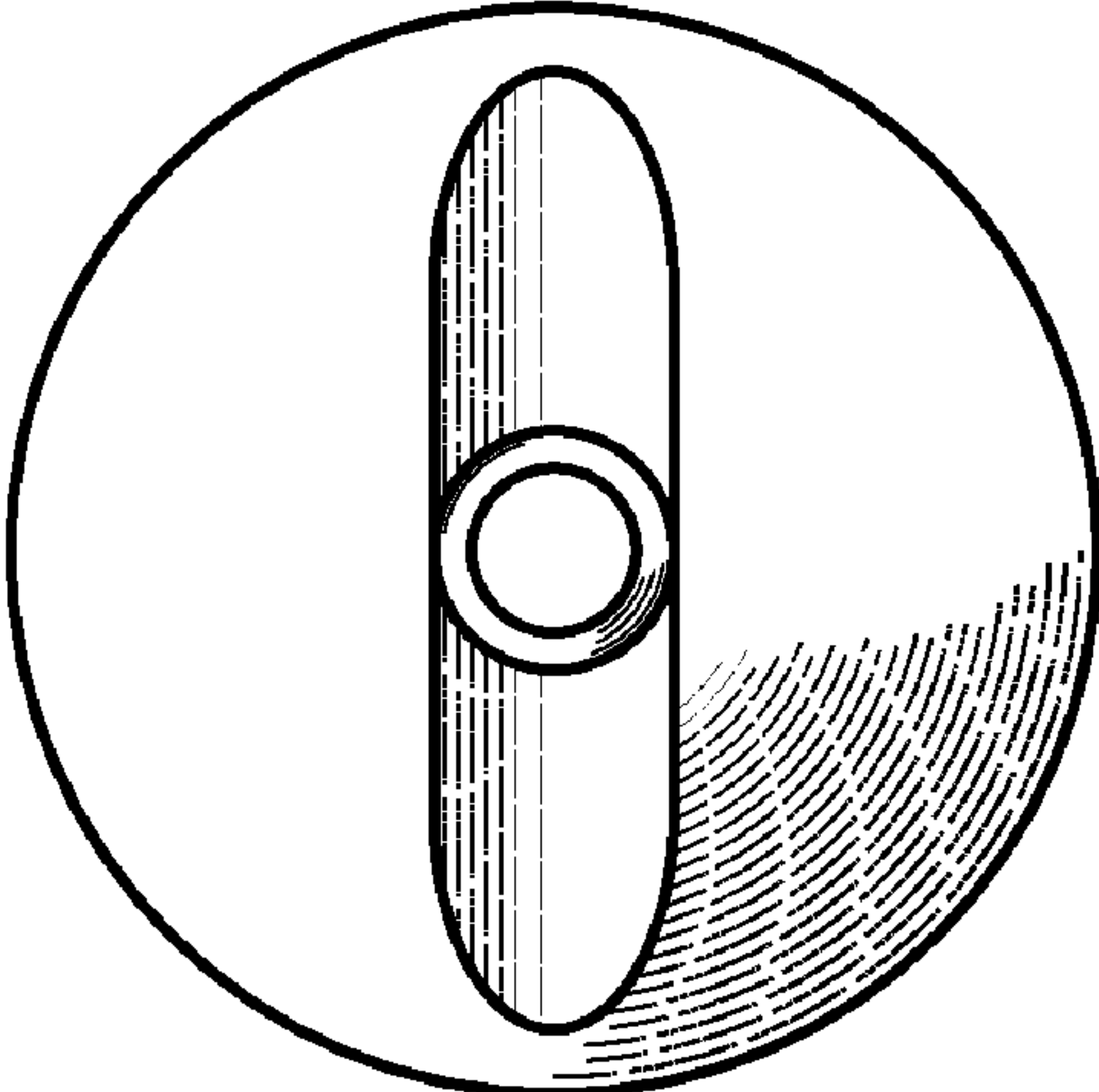

FIG 6

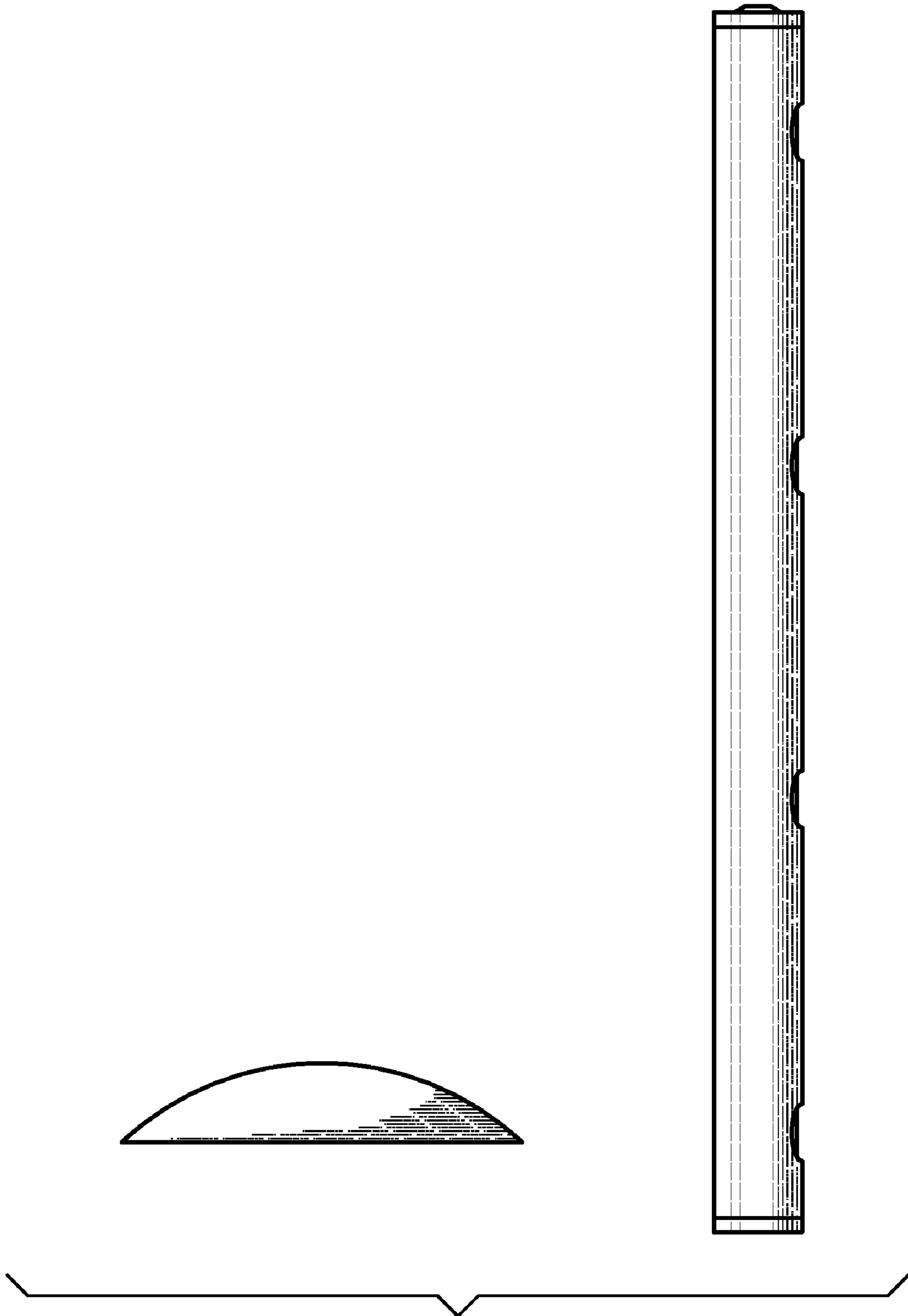

FIG 7

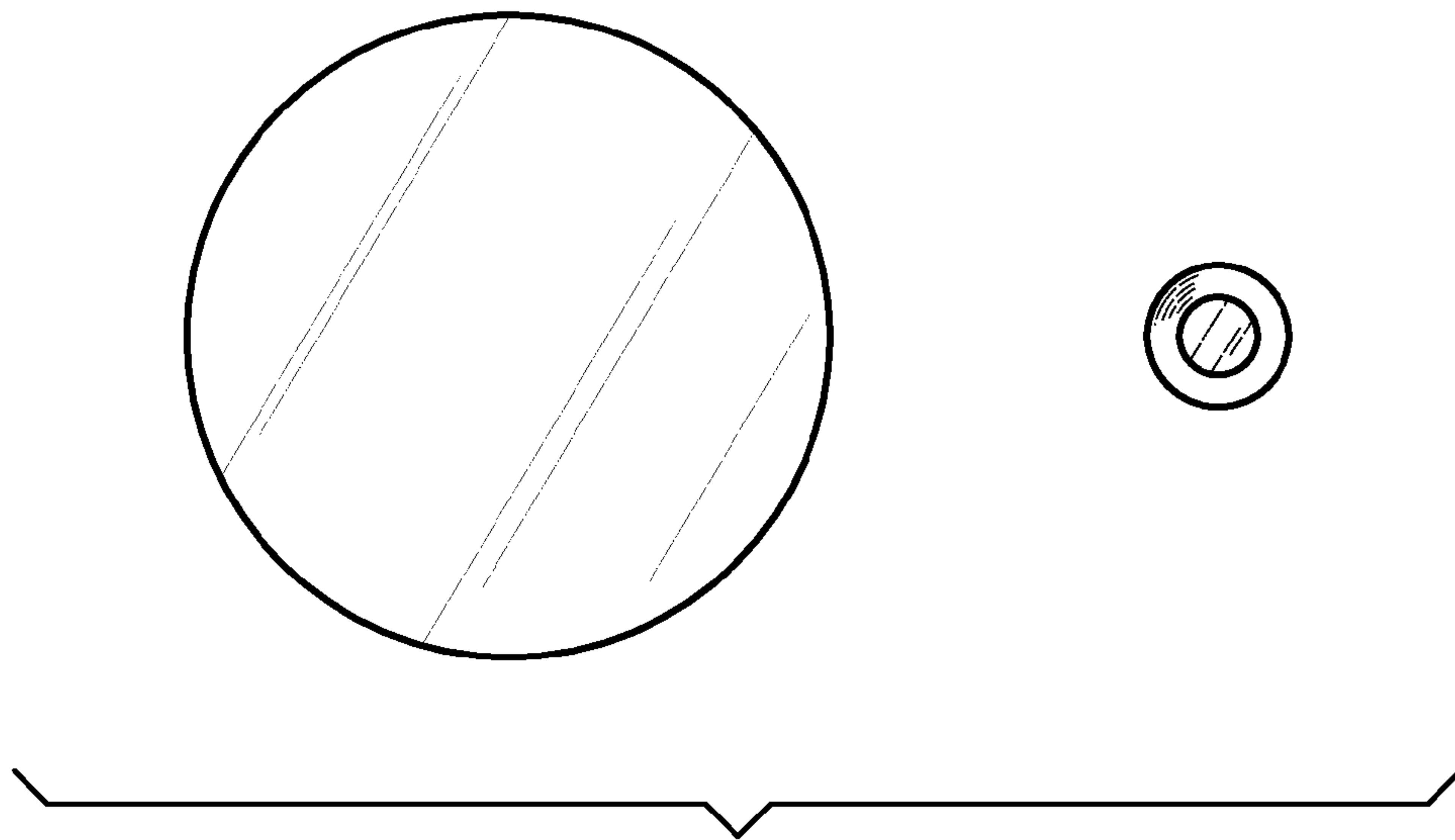

FIG 8

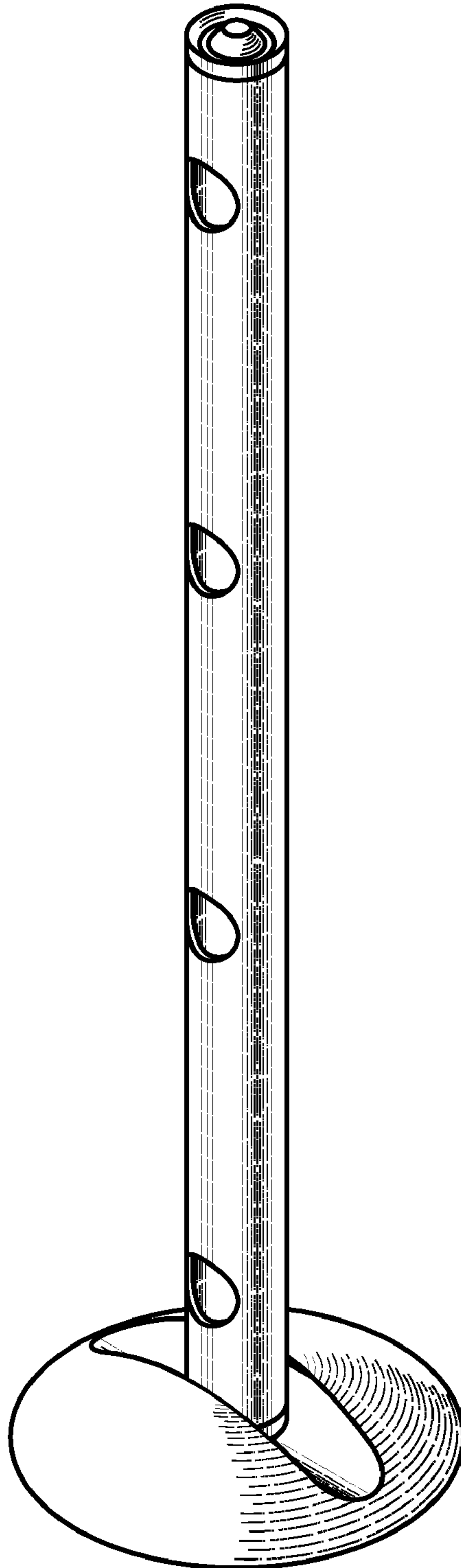

FIG 9

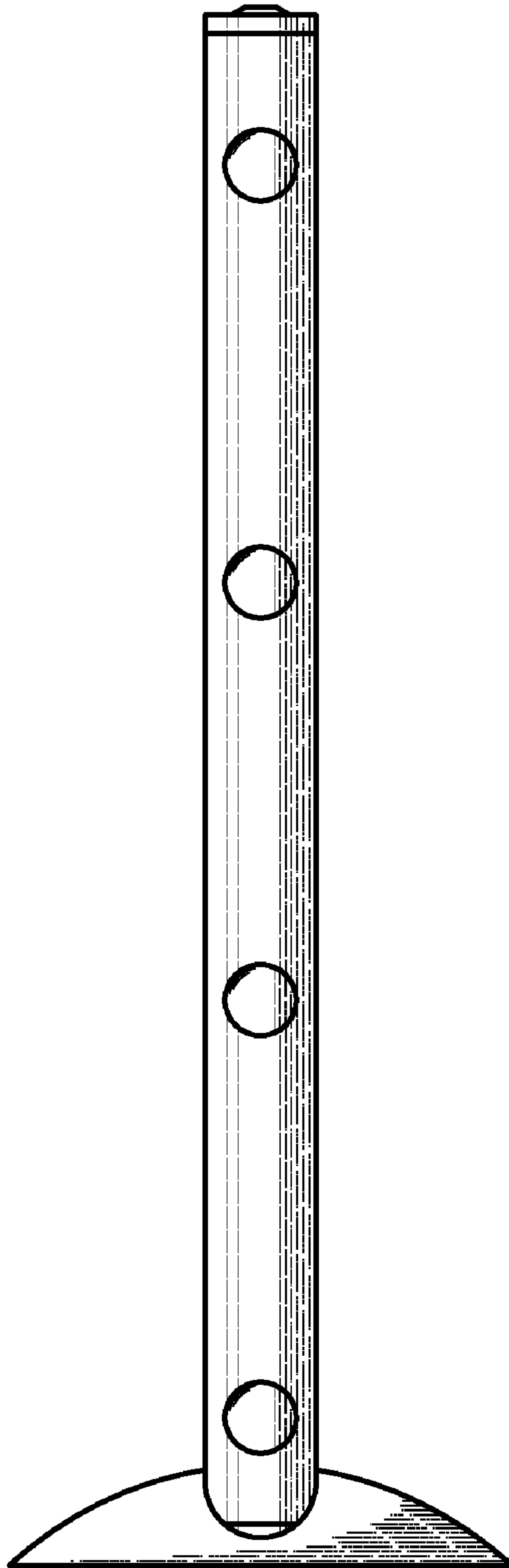

FIG 10

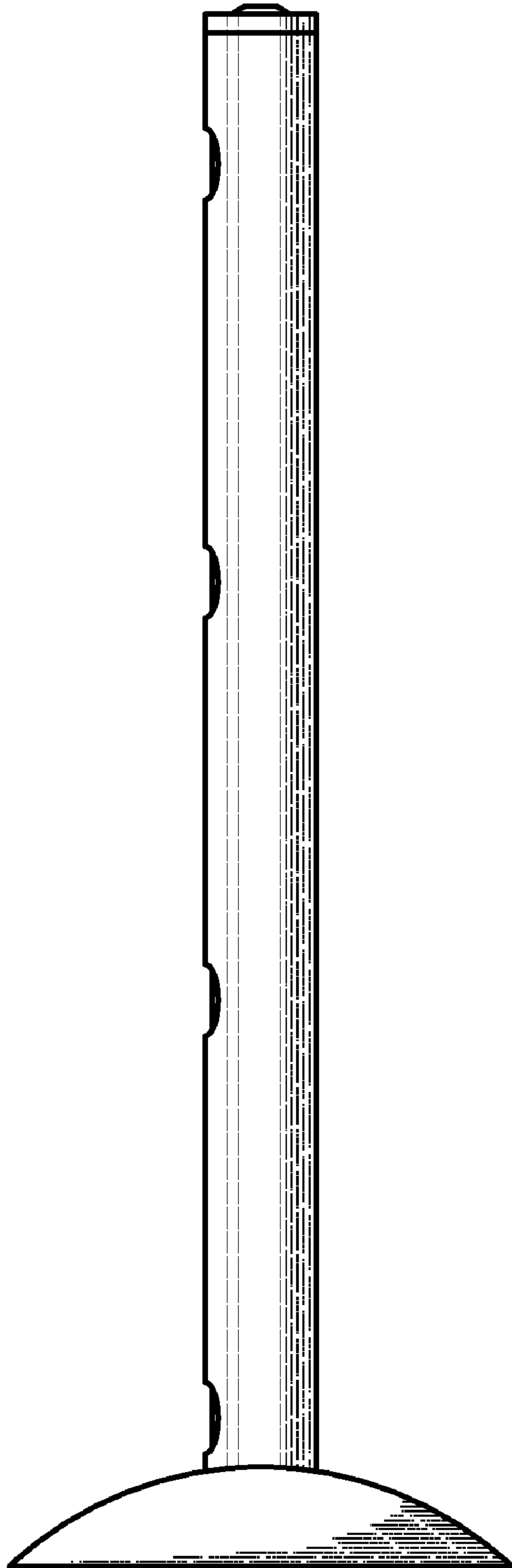

FIG 11

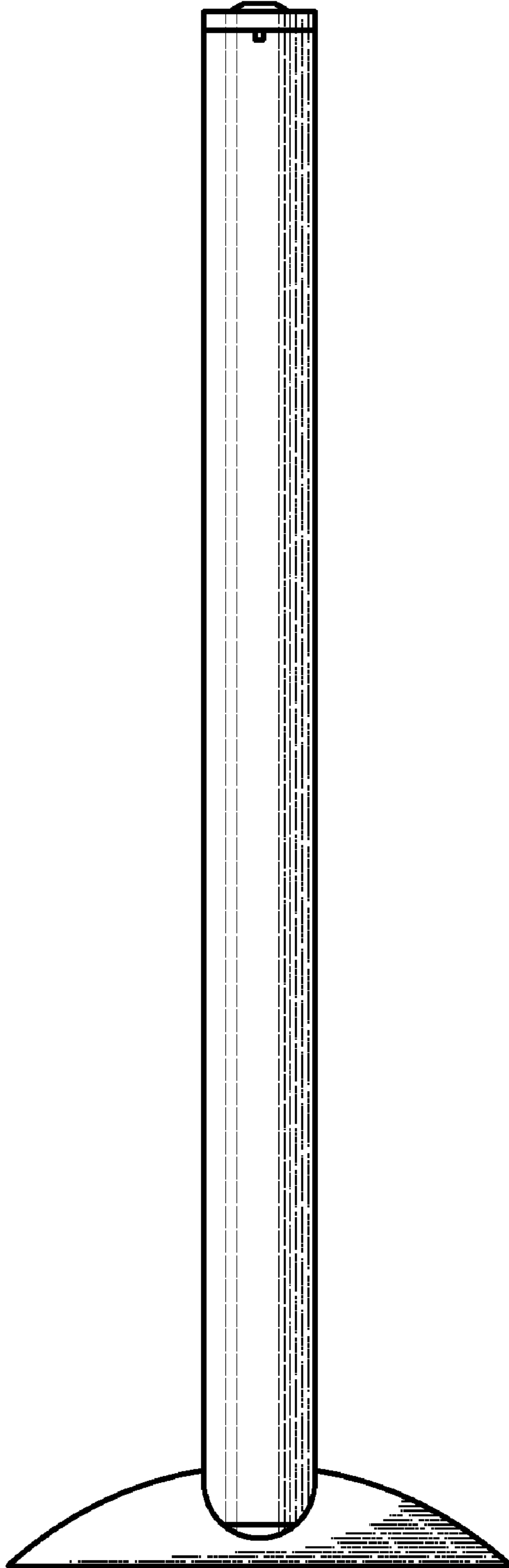

FIG 12

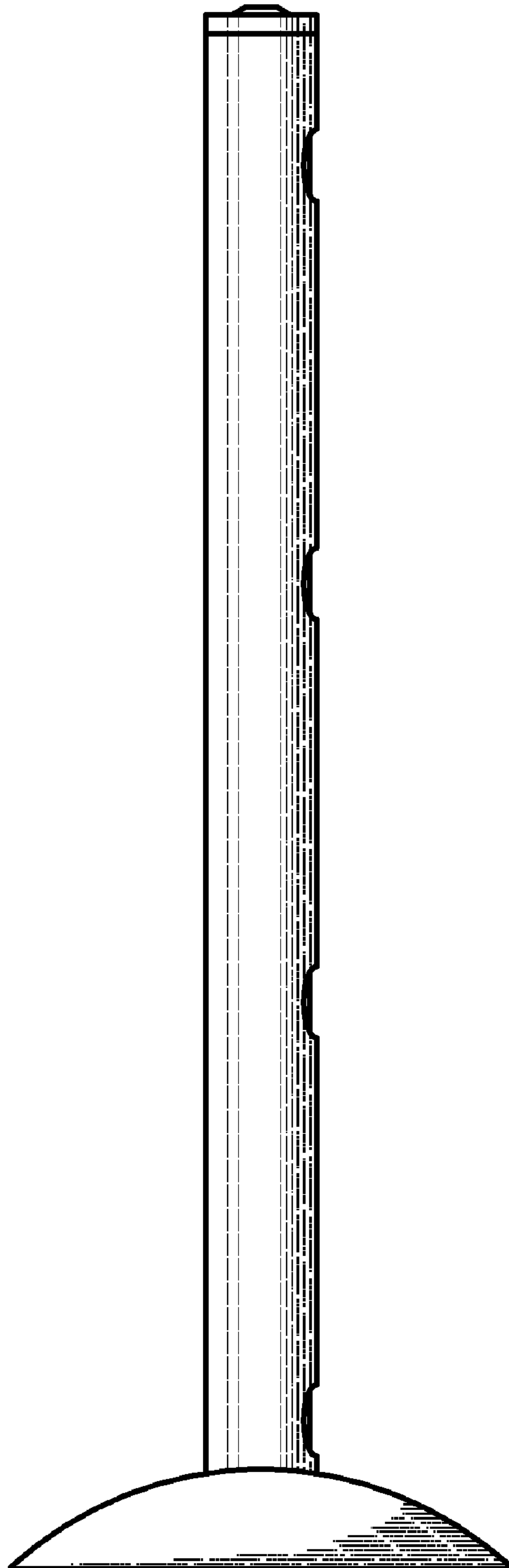

FIG 13

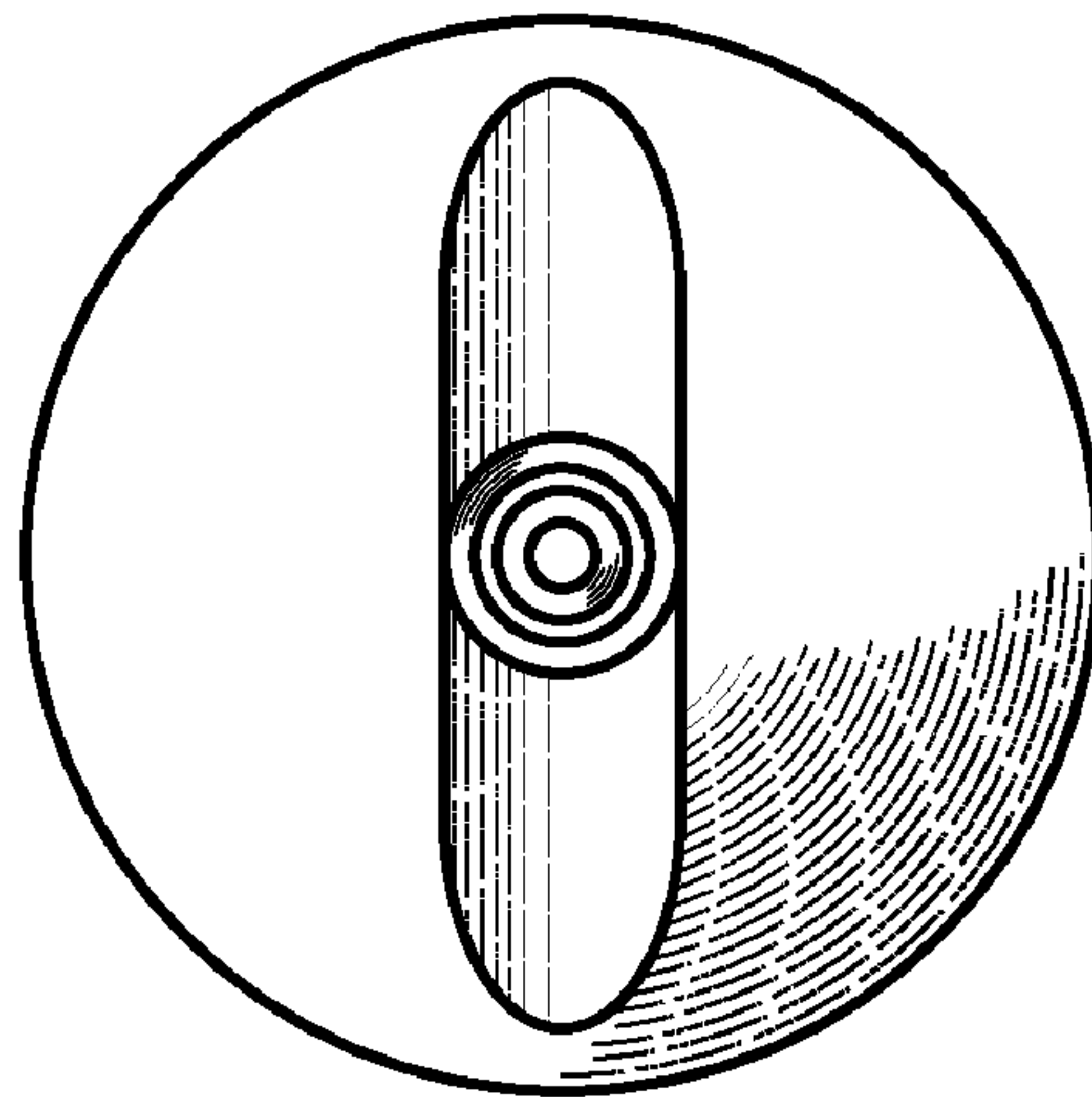

FIG 14

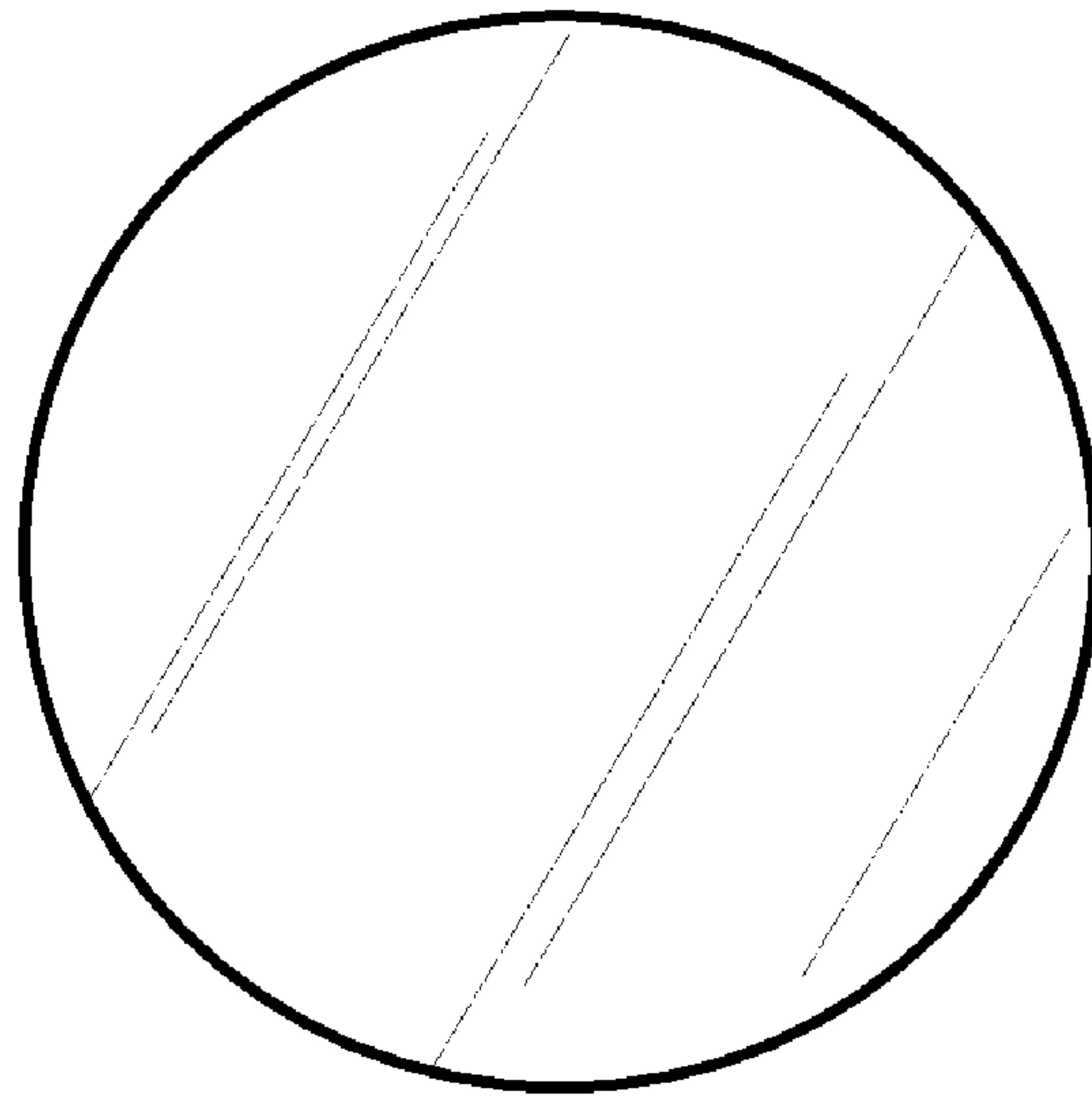

FIG 15

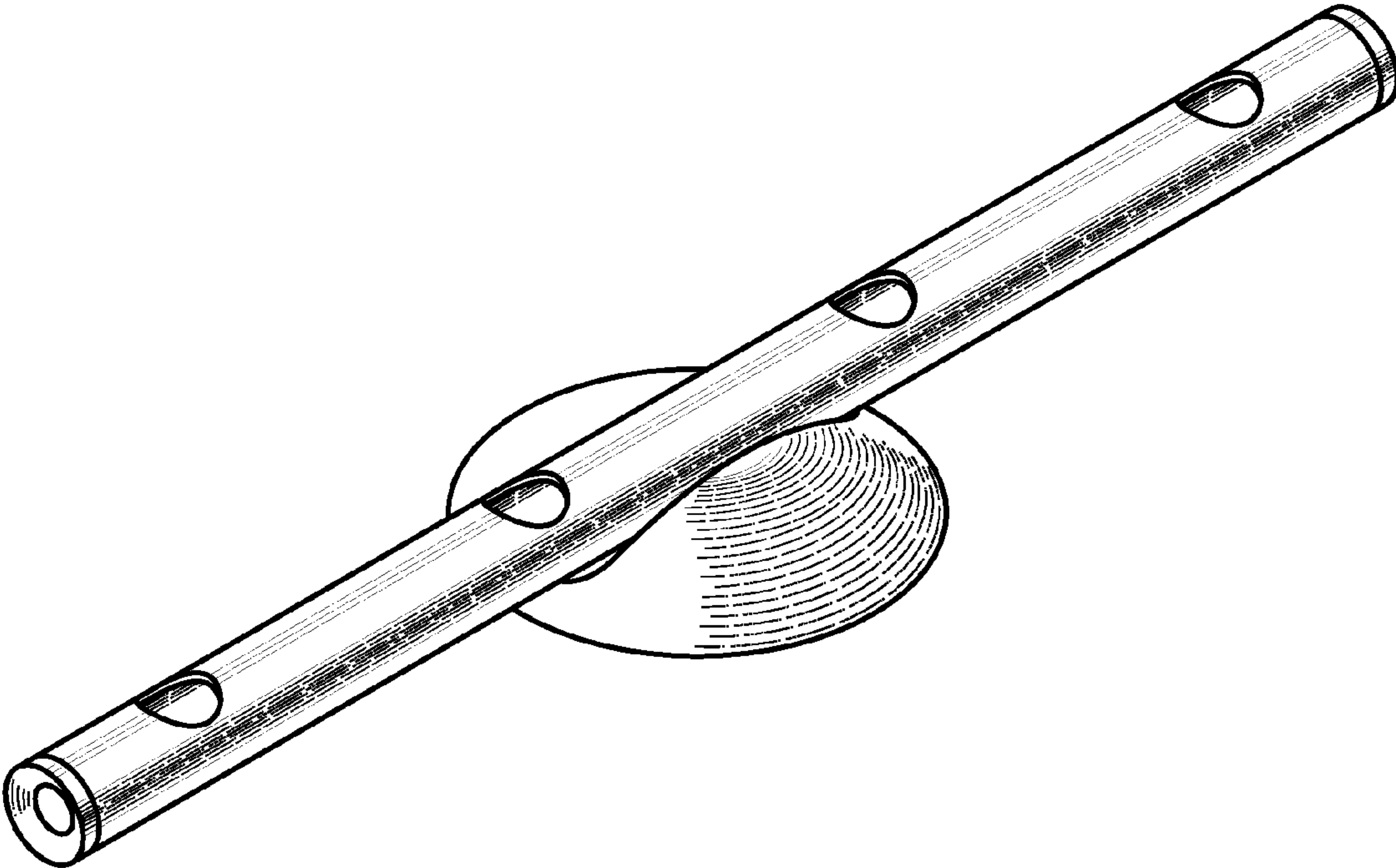

FIG 16

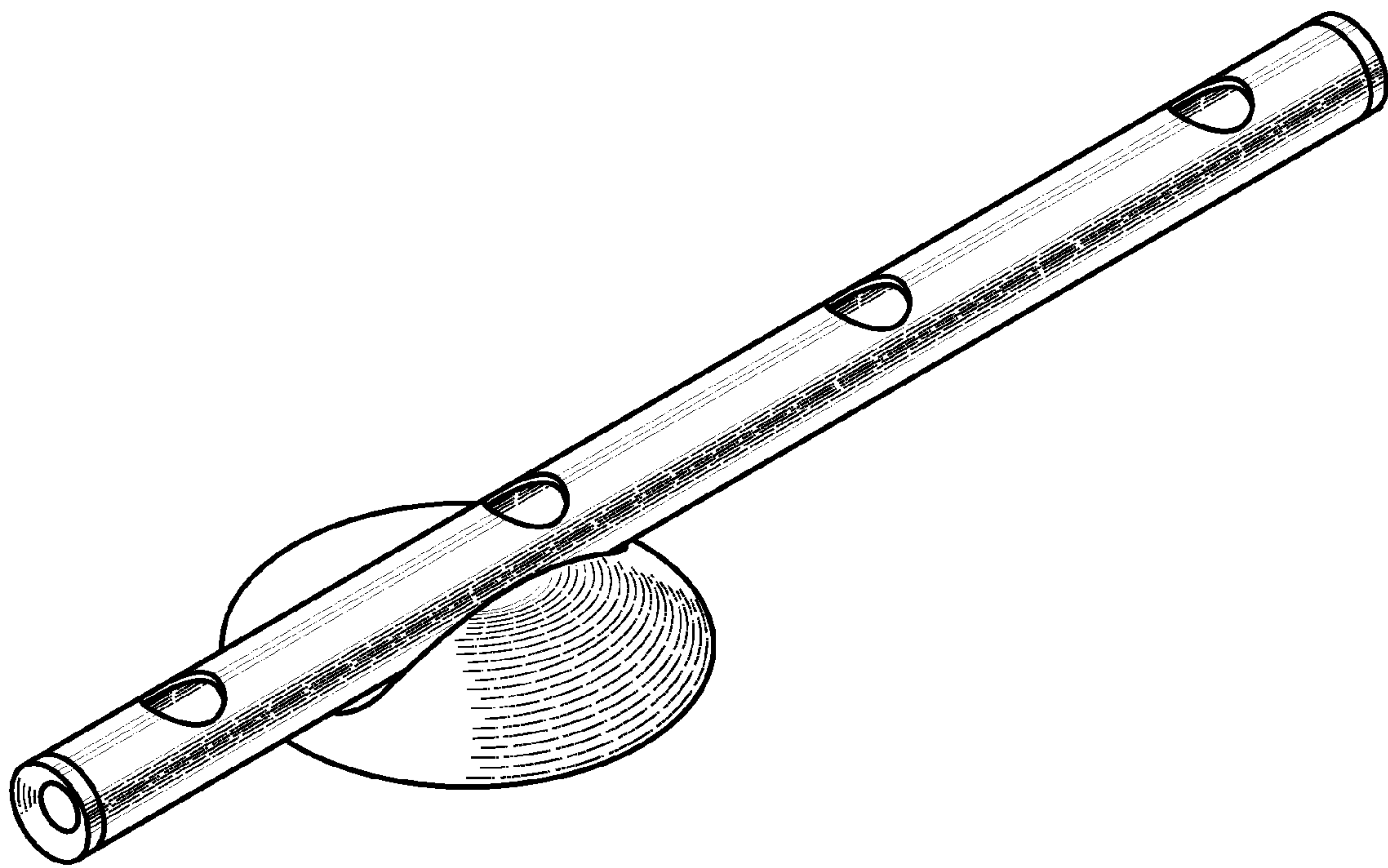

FIG 17

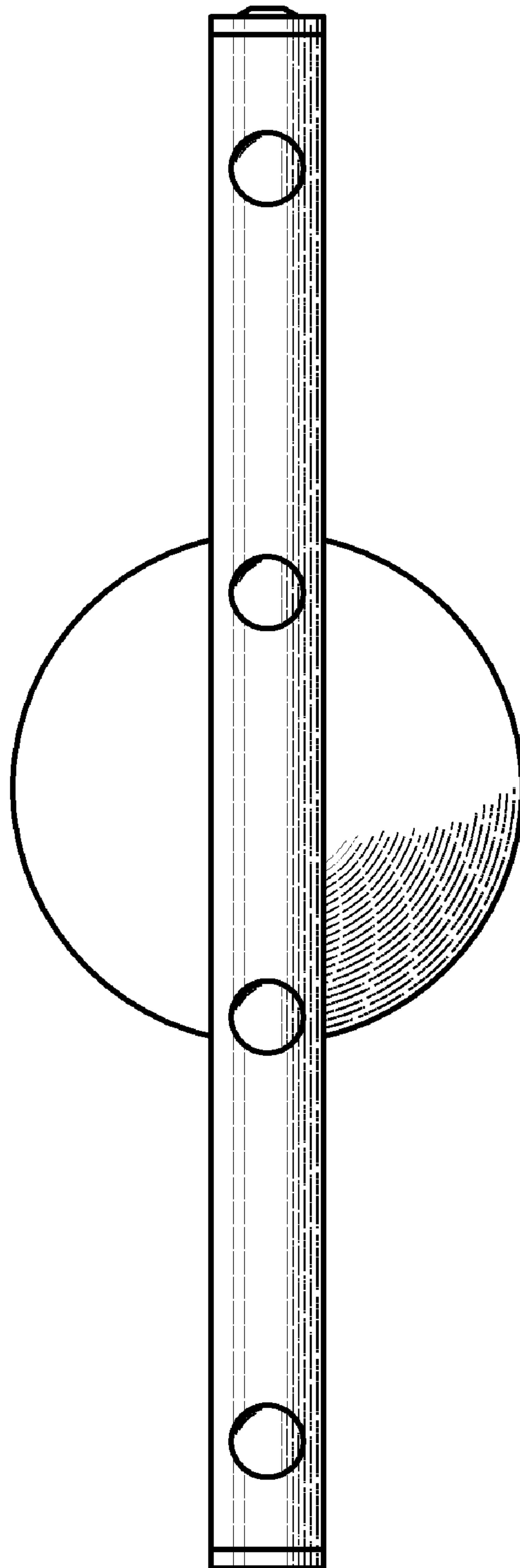

FIG 18

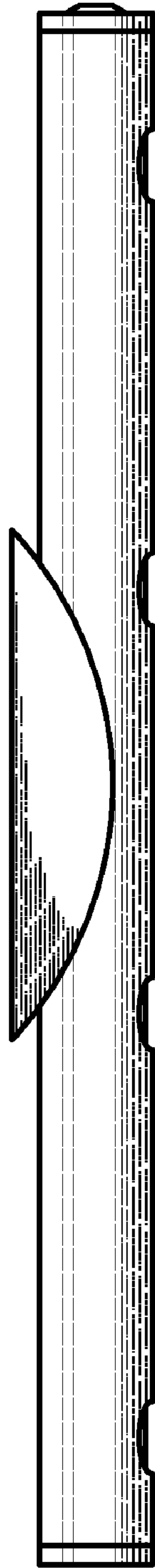

FIG 19

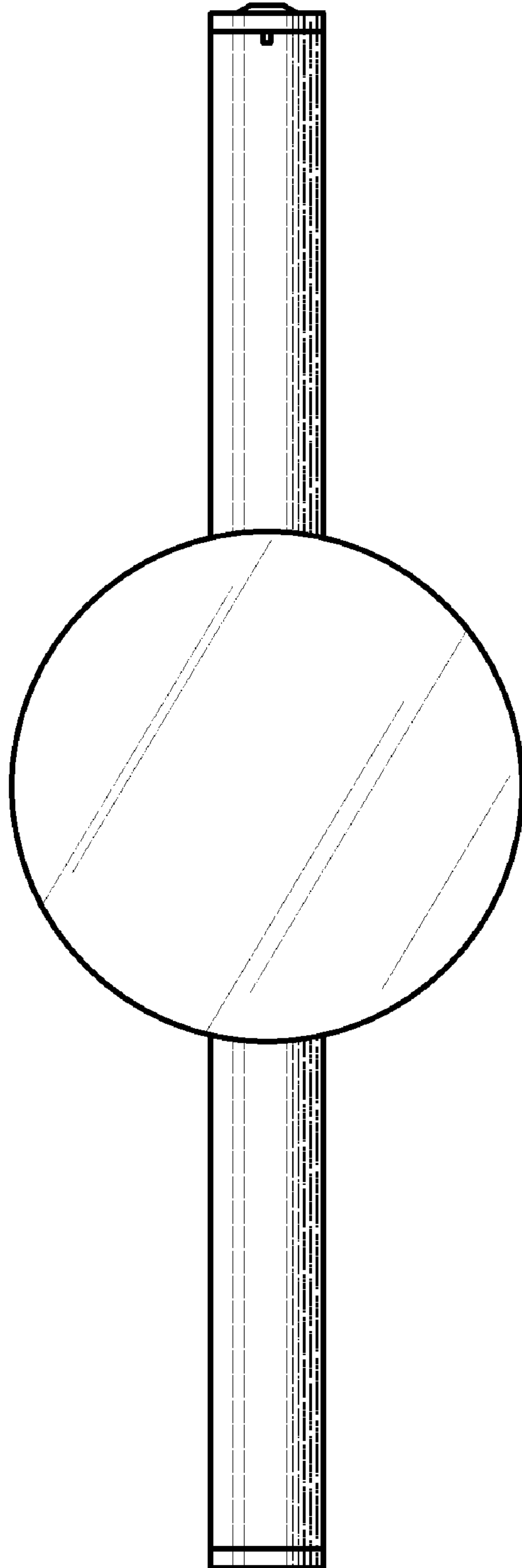

FIG 20

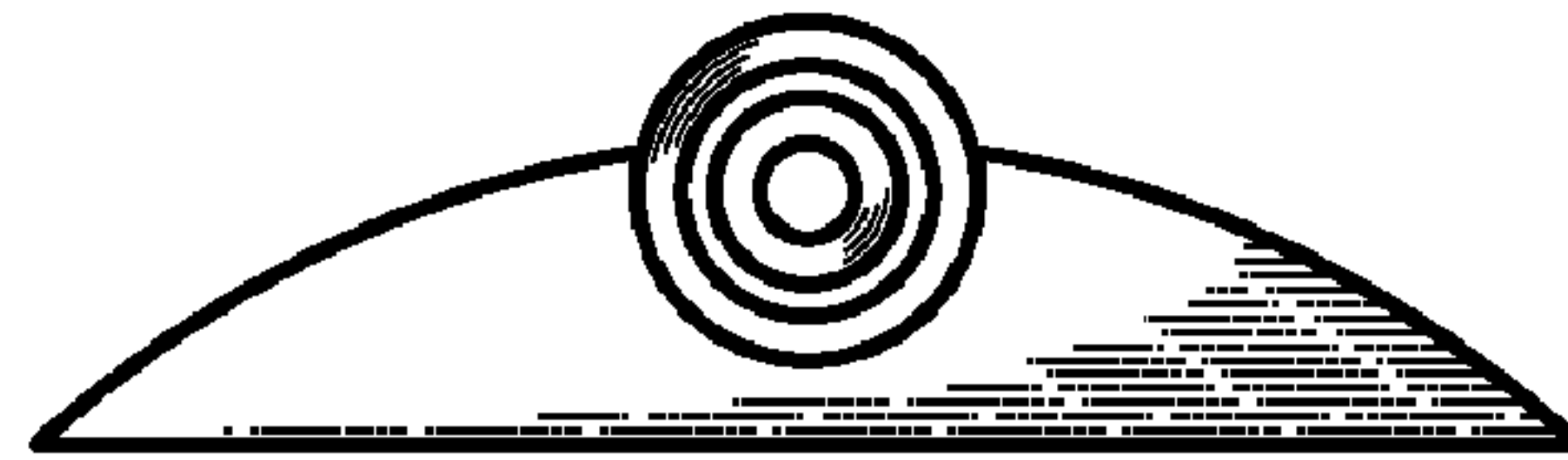

FIG 21

