



US00D620577S

(12) **United States Design Patent**
Hsiao

(10) **Patent No.:** **US D620,577 S**

(45) **Date of Patent:** **** Jul. 27, 2010**

(54) **AROMATIC DEVICE**

(76) Inventor: **Ming Jen Hsiao**, 2, Lane 200, Bate 2nd
Road, Toufen, Miaoli County (TW)

(**) Term: **14 Years**

(21) Appl. No.: **29/346,916**

(22) Filed: **Nov. 9, 2009**

(51) **LOC (9) Cl.** **28-99**

(52) **U.S. Cl.** **D23/366**

(58) **Field of Classification Search** D23/355-369;
D28/5, 6; 261/DIG. 17, DIG. 42, DIG. 65,
261/DIG. 88, DIG. 89; 392/386, 390, 391,
392/392, 394, 395, 389, 393; 239/34, 35,
239/43-45, 53, 56, 57, 60, 326, 42, 50, 55
See application file for complete search history.

(56) **References Cited**

U.S. PATENT DOCUMENTS

6,050,551 A * 4/2000 Anderson 261/30
D449,371 S * 10/2001 Bornstein et al. D23/360
D451,183 S * 11/2001 Hirano et al. D23/366
D535,376 S * 1/2007 Michaels et al. D23/366

D544,084 S * 6/2007 Michaels et al. D23/366
D549,313 S * 8/2007 Kelnhofer D23/360
D582,533 S * 12/2008 Bodine D23/366
D583,451 S * 12/2008 Aloe et al. D23/366
D583,452 S * 12/2008 Aloe et al. D23/366

* cited by examiner

Primary Examiner—Sandra Snapp

(74) *Attorney, Agent, or Firm*—Ming Chow; Sinorica, LLC

(57) **CLAIM**

The ornamental design for an aromatic device, as shown.

DESCRIPTION

FIG. 1 is a perspective view of the design for an aromatic device;

FIG. 2 is a front view of the design;

FIG. 3 is a rear view of the design;

FIG. 4 is a right side view of the design;

FIG. 5 is a left side view of the design;

FIG. 6 is a top view of the design; and,

FIG. 7 is a bottom view of the design.

1 Claim, 7 Drawing Sheets

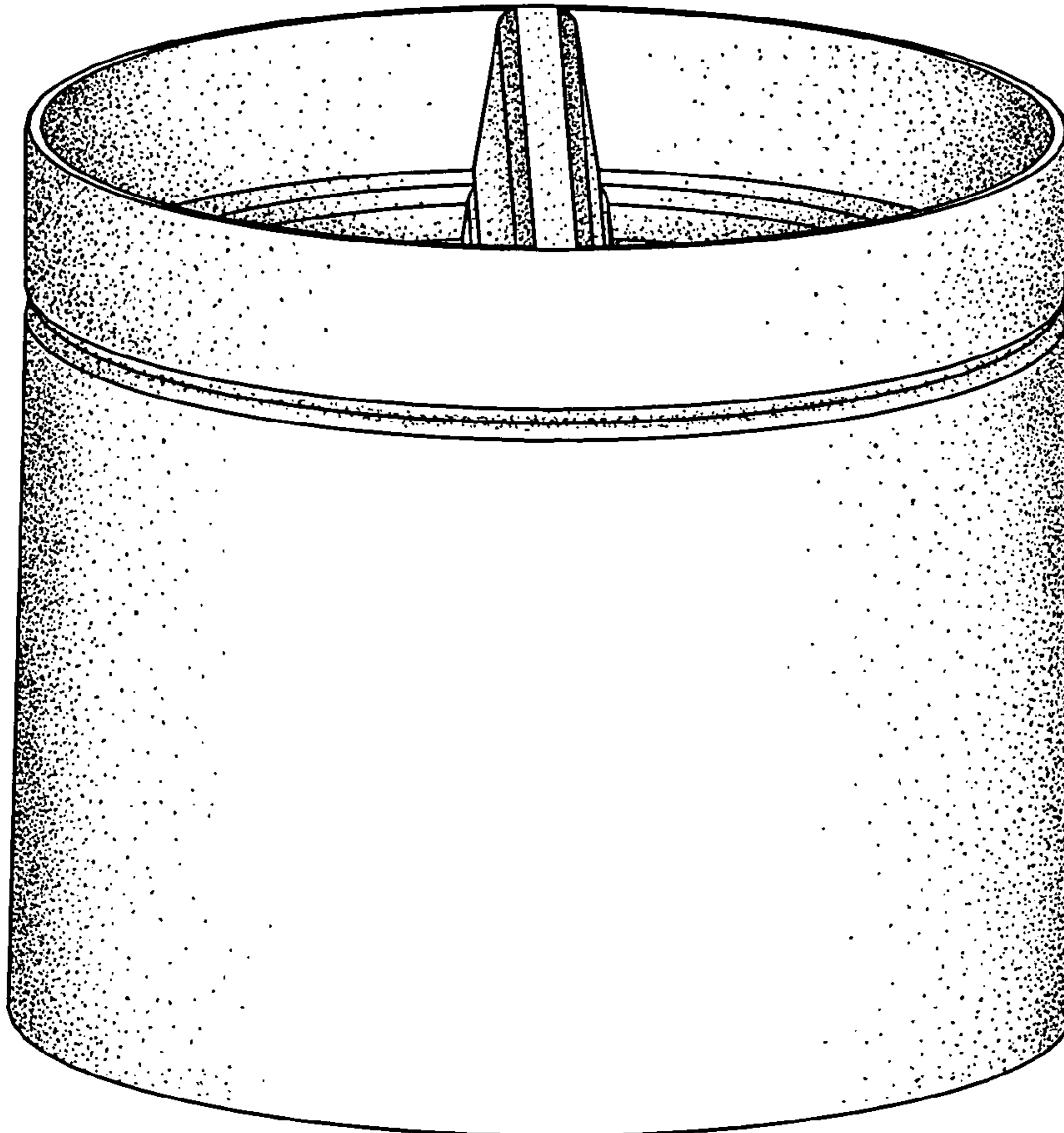

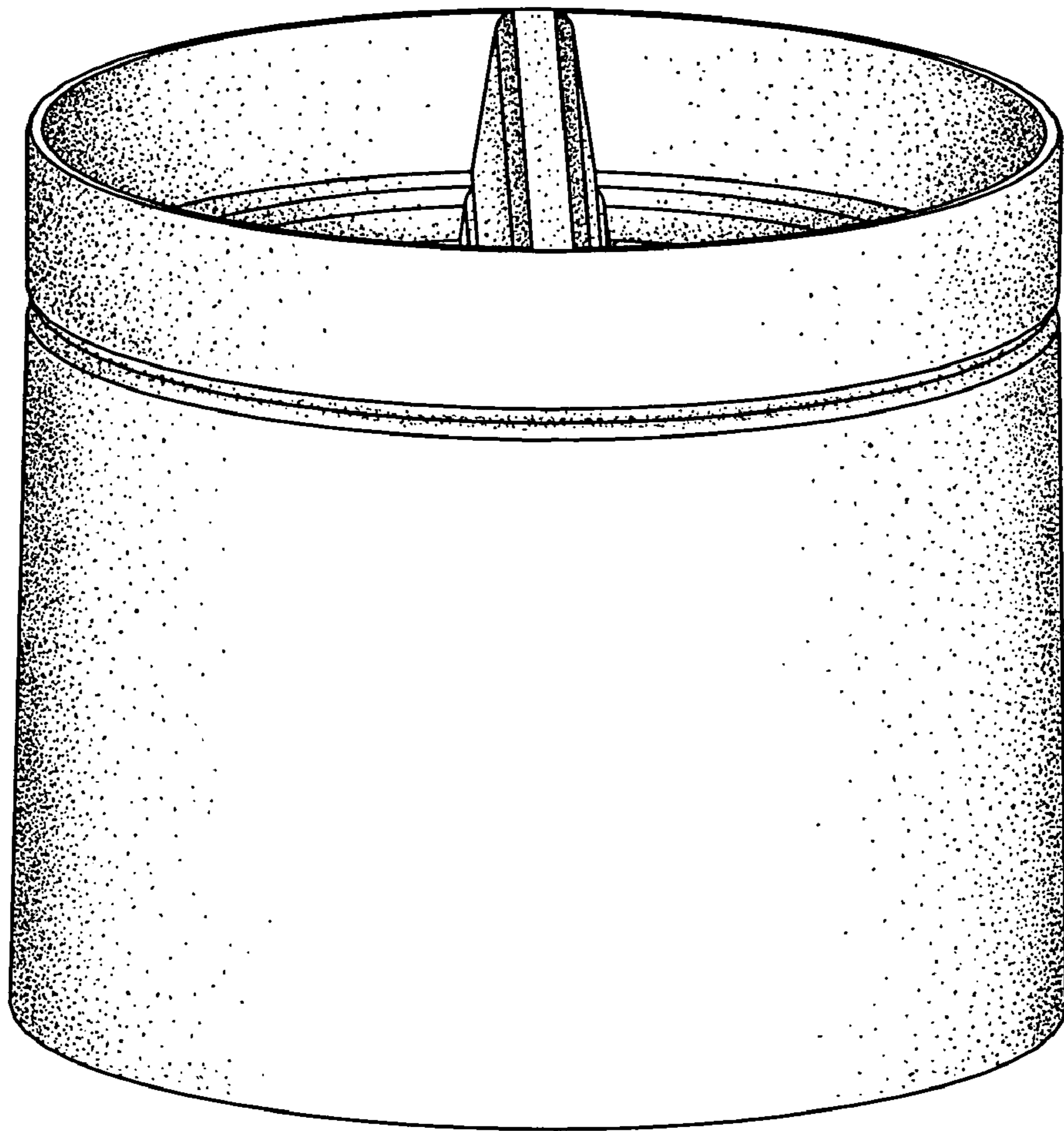

FIG. 1

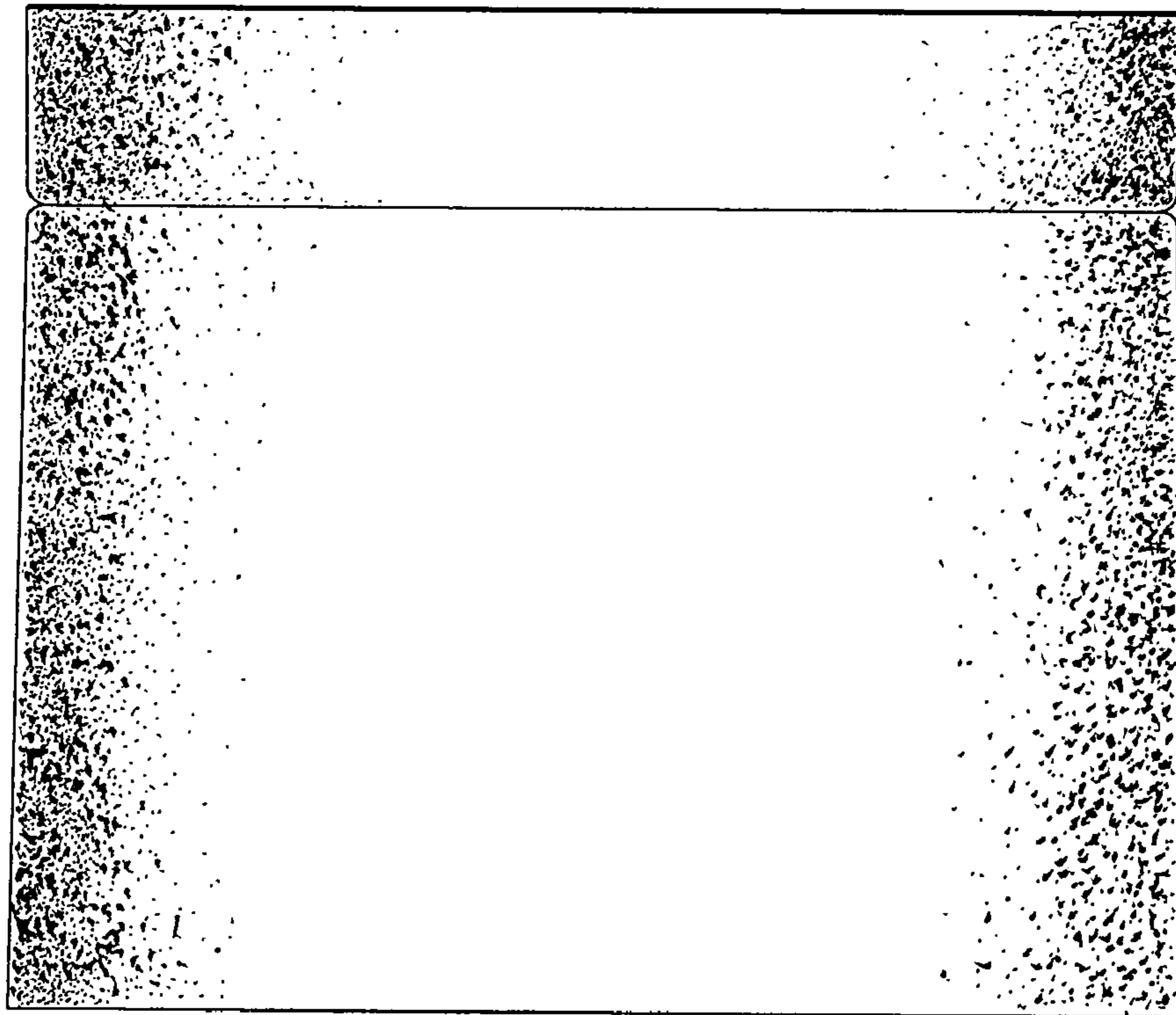

FIG. 2

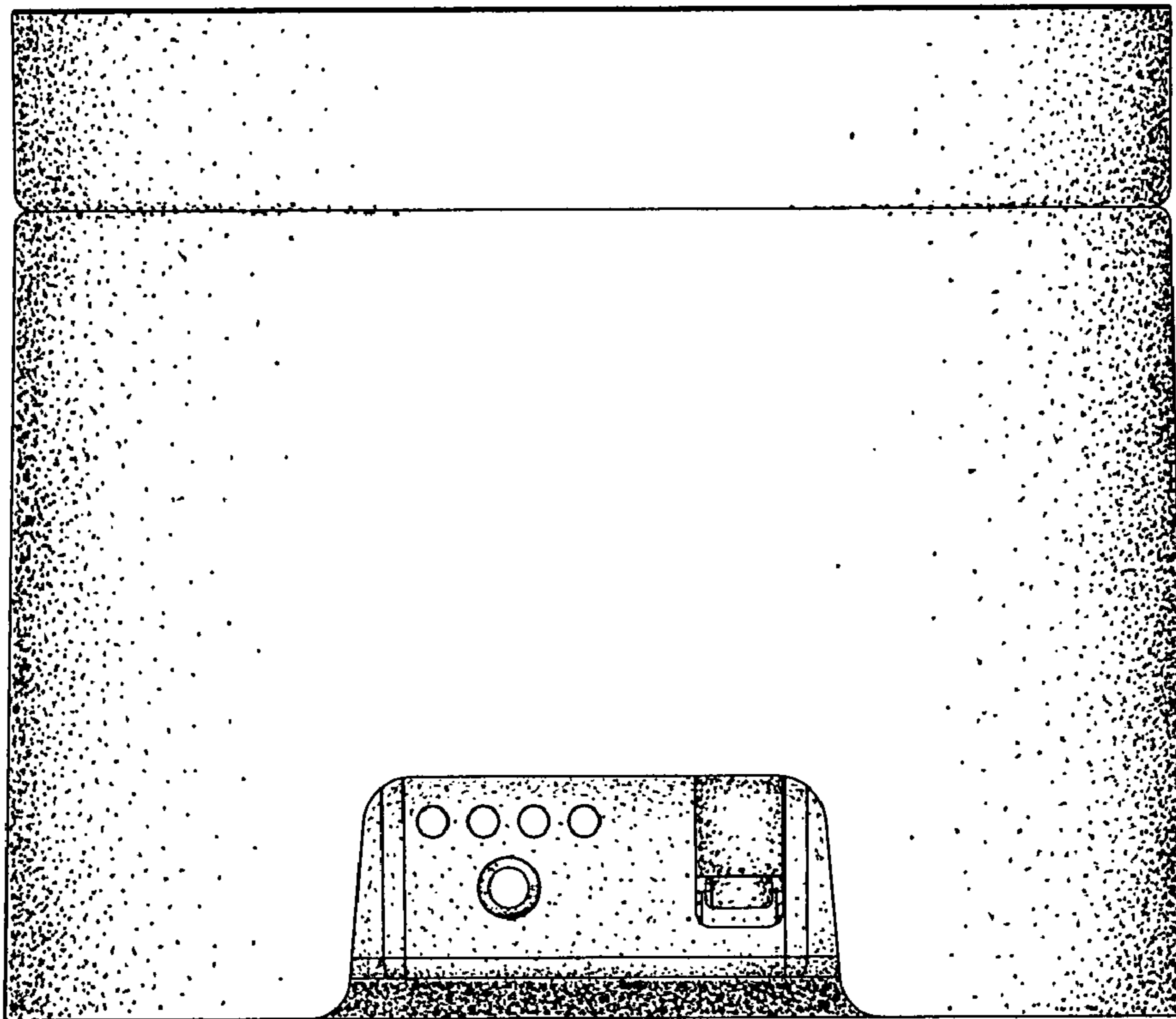

FIG. 3

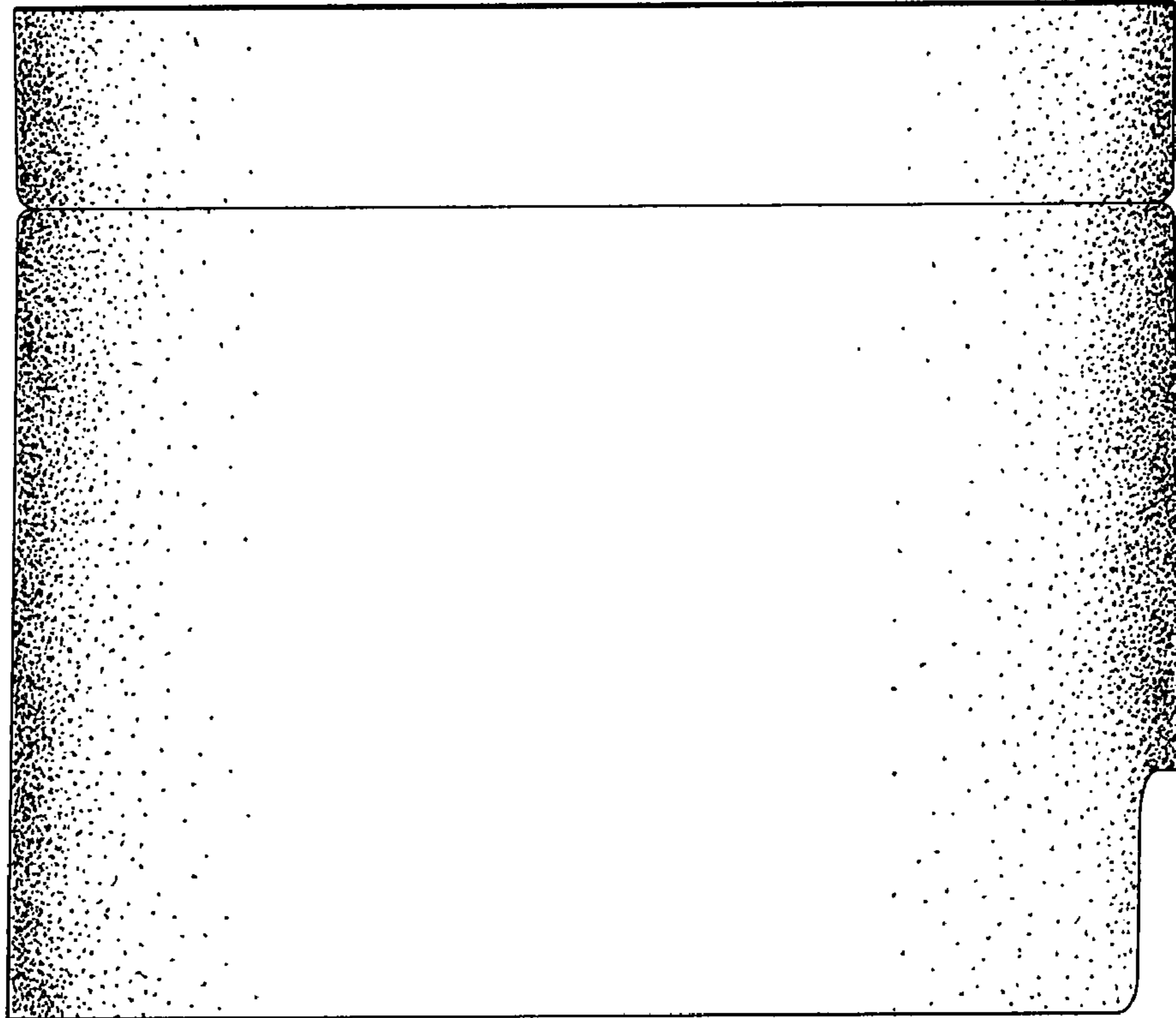

FIG. 4

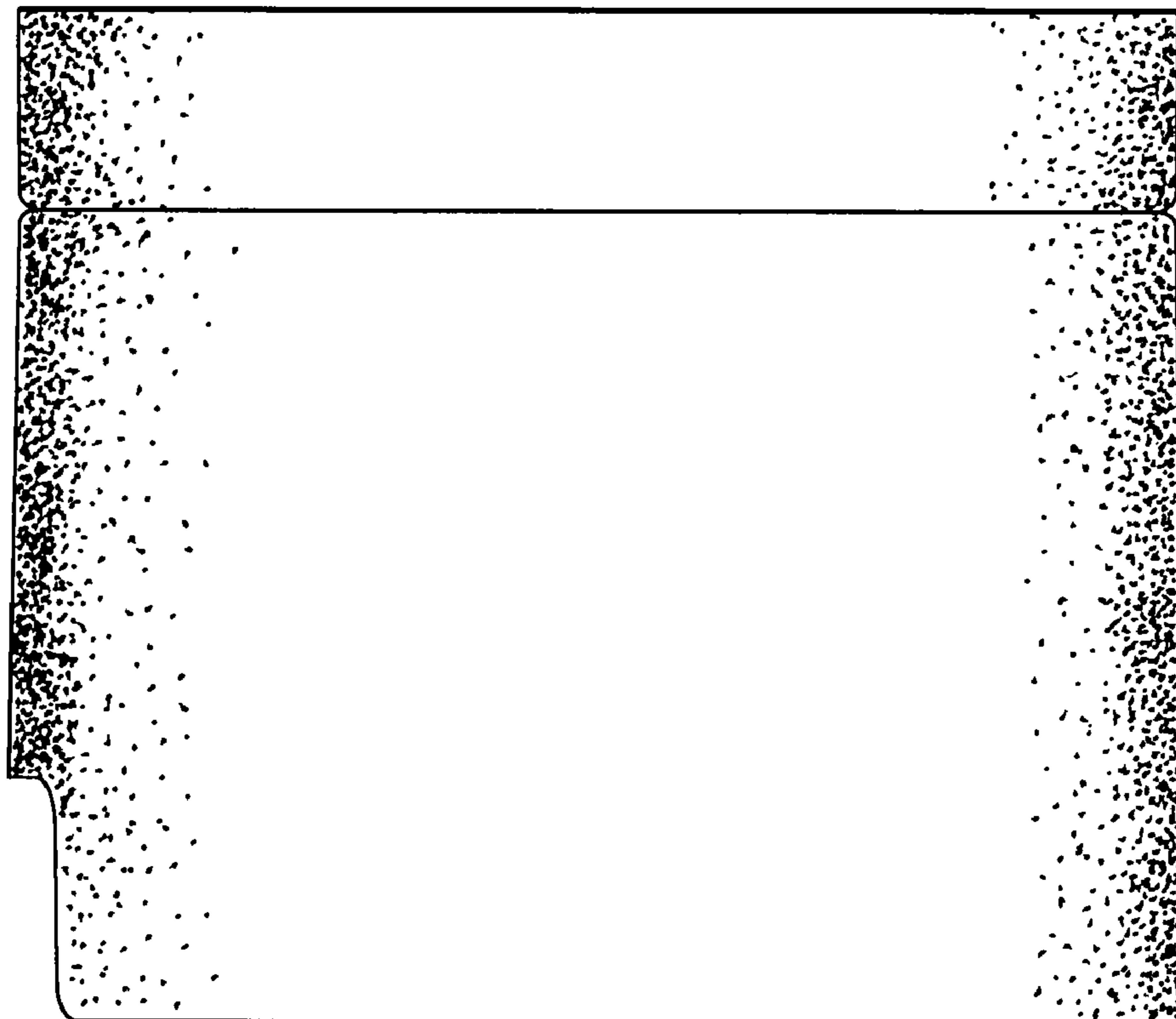

FIG. 5

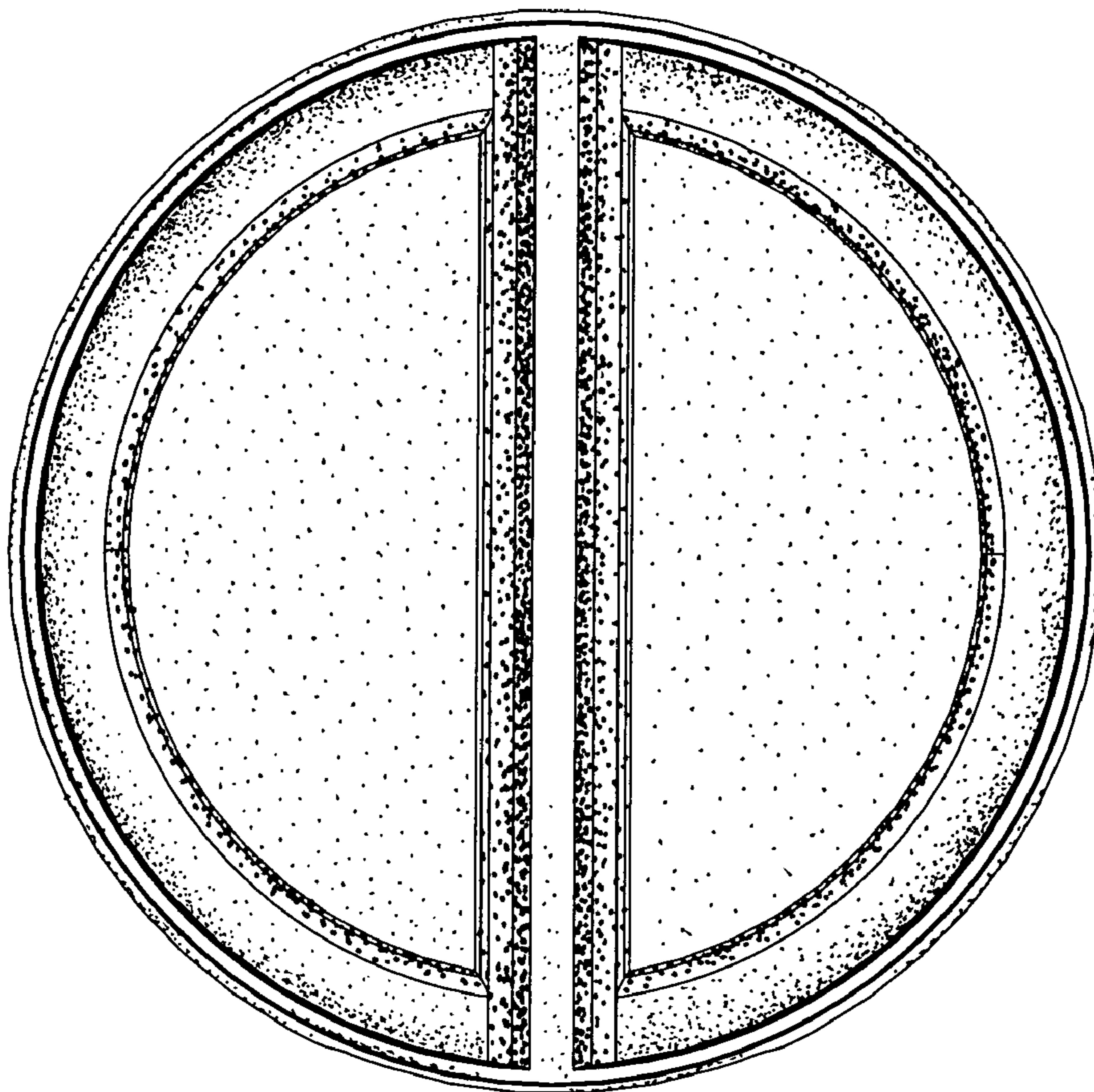

FIG. 6

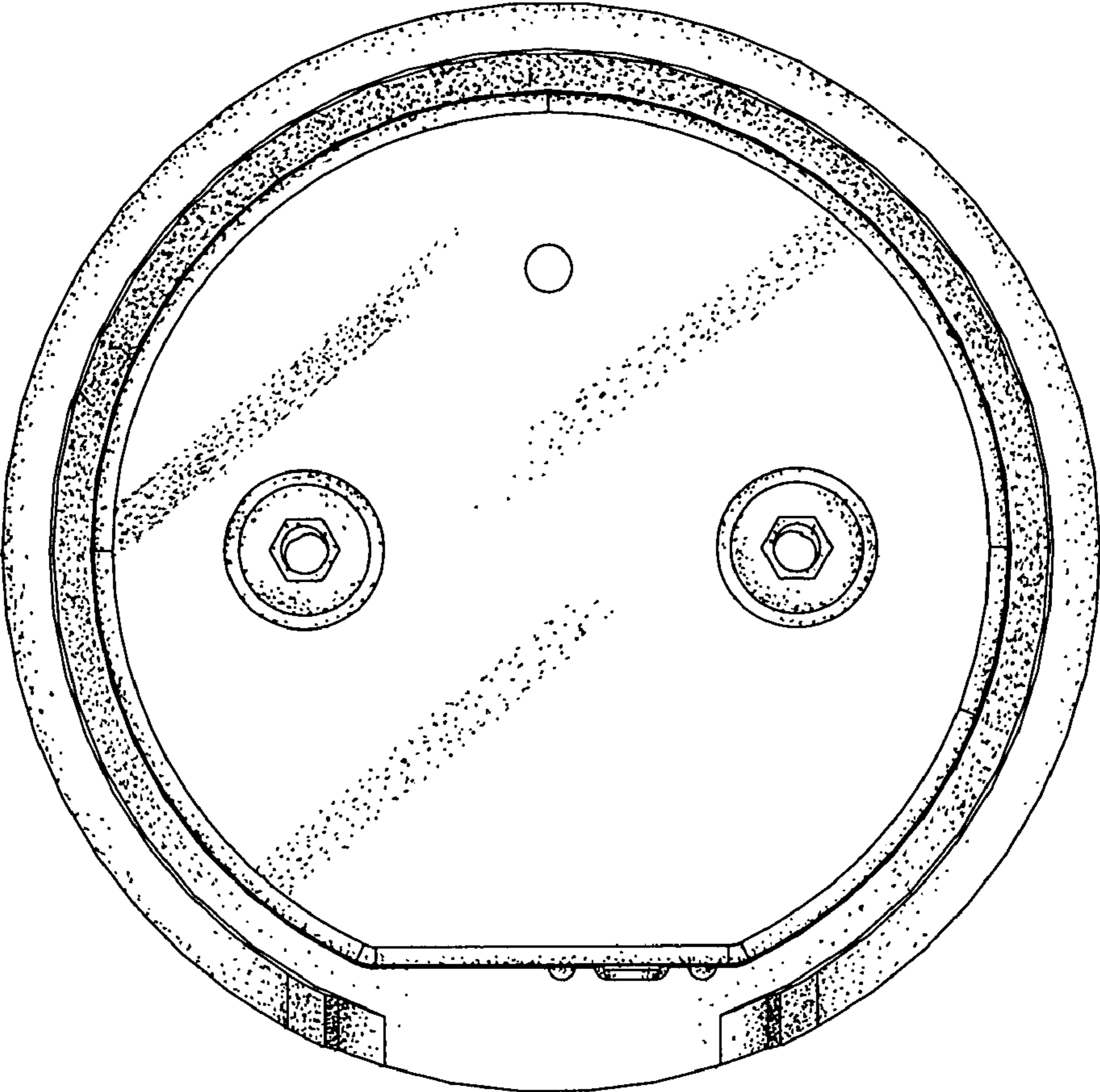

FIG. 7