

US00D620568S

(12) **United States Design Patent**
Giovannoni

(10) **Patent No.:** **US D620,568 S**

(45) **Date of Patent:** **** Jul. 27, 2010**

(54) **TOILET SEAT WITH CLEANING FUNCTION**

D601,681 S * 10/2009 Cho D23/295

(75) Inventor: **Stefano Giovannoni**, Milan (IT)

* cited by examiner

(73) Assignee: **Toto Ltd.**, Kitakyushu-Shi (JP)

Primary Examiner—Robert A Delehanty

(74) *Attorney, Agent, or Firm*—Birch, Stewart, Kolasch & Birch, LLP

(**) Term: **14 Years**

(21) Appl. No.: **29/333,658**

(57) **CLAIM**

(22) Filed: **Mar. 12, 2009**

The ornamental design for a toilet seat with cleaning function, as shown and described.

(30) **Foreign Application Priority Data**

Jan. 29, 2009 (JP) 2009-001738

DESCRIPTION

(51) **LOC (9) Cl.** **23-02**

FIG. 1 is a perspective view of the top, front and right side of a toilet seat with cleaning function showing my new design;

(52) **U.S. Cl.** **D23/311**

FIG. 2 is a front view thereof;

(58) **Field of Classification Search** D23/303,

FIG. 3 is a rear view thereof;

D23/309, 311; 4/444, 234, 237, 242.1

FIG. 4 is a left side view thereof;

See application file for complete search history.

FIG. 5 is a right side view thereof;

(56) **References Cited**

FIG. 6 is a top plan view thereof; and,

U.S. PATENT DOCUMENTS

FIG. 7 is a bottom view thereof.

D458,990 S * 6/2002 Yamanaka et al. D23/311

1 Claim, 5 Drawing Sheets

D463,853 S * 10/2002 Yamanaka et al. D23/311

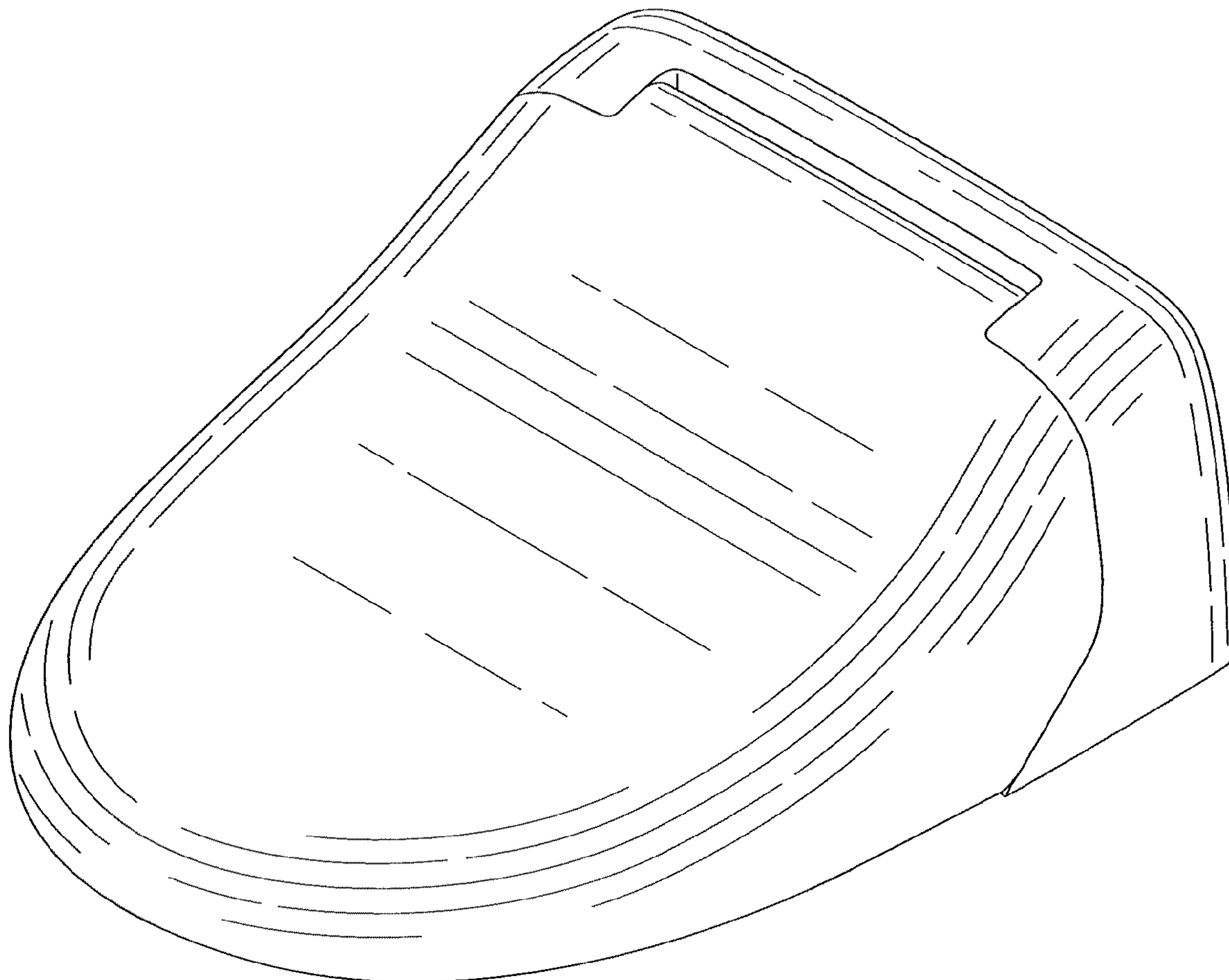

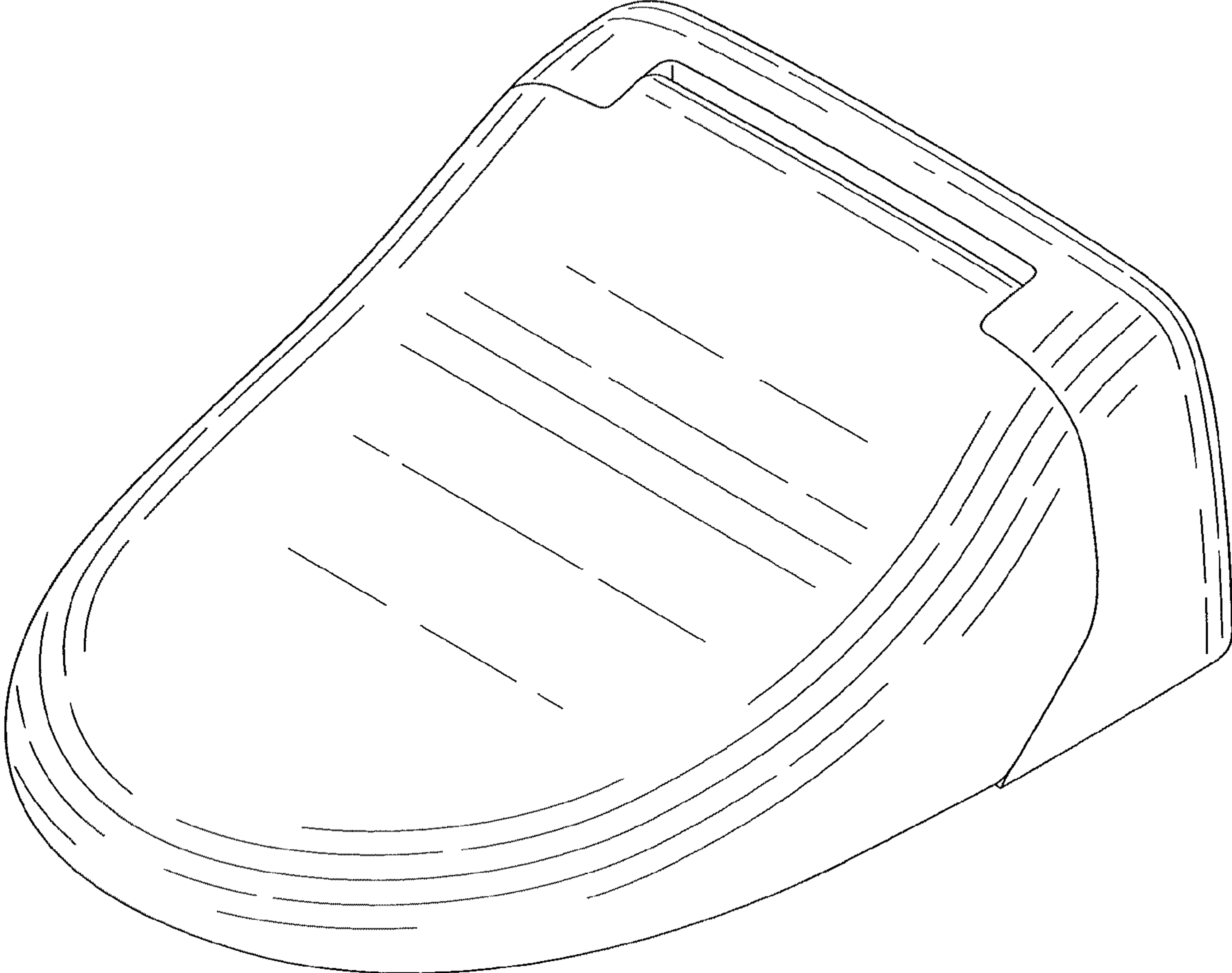

FIG. 1

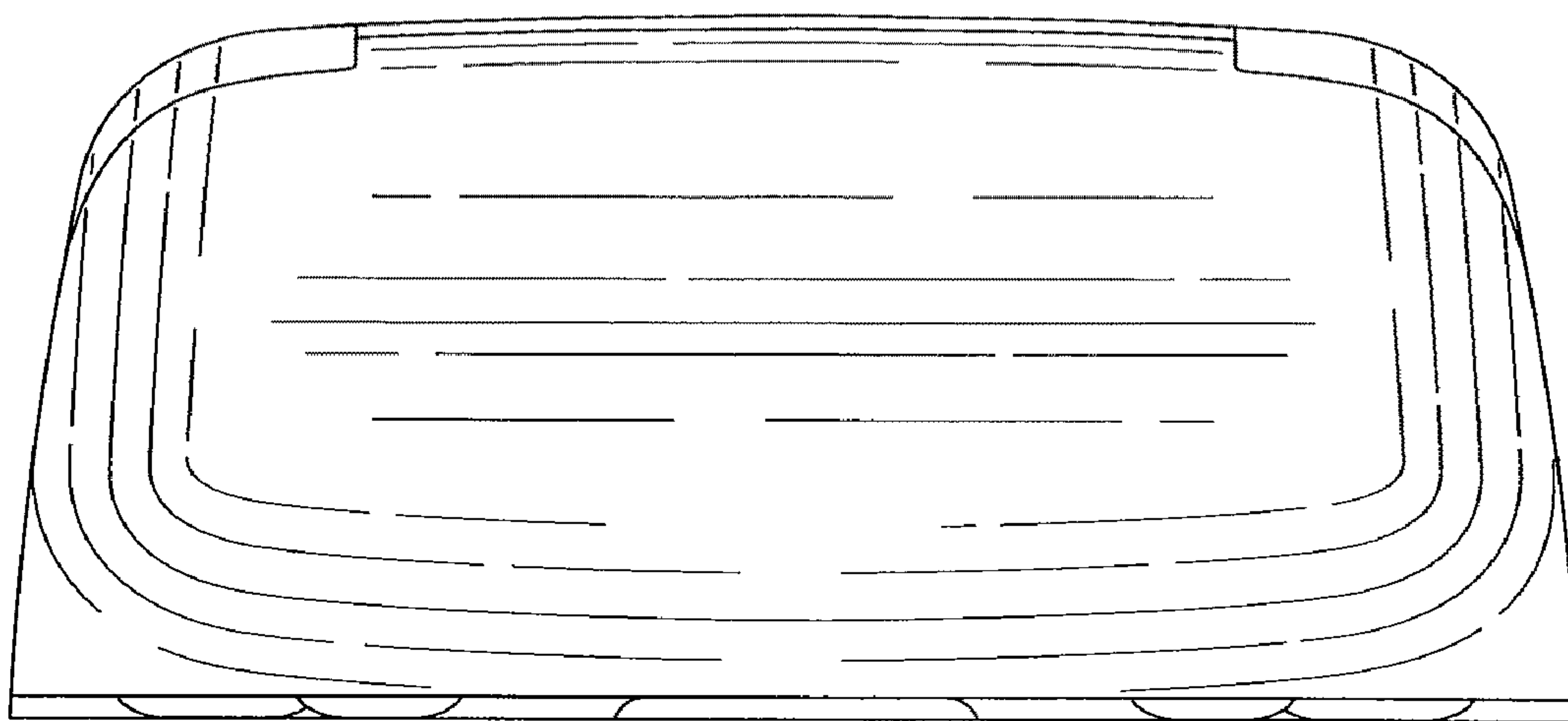

FIG. 2

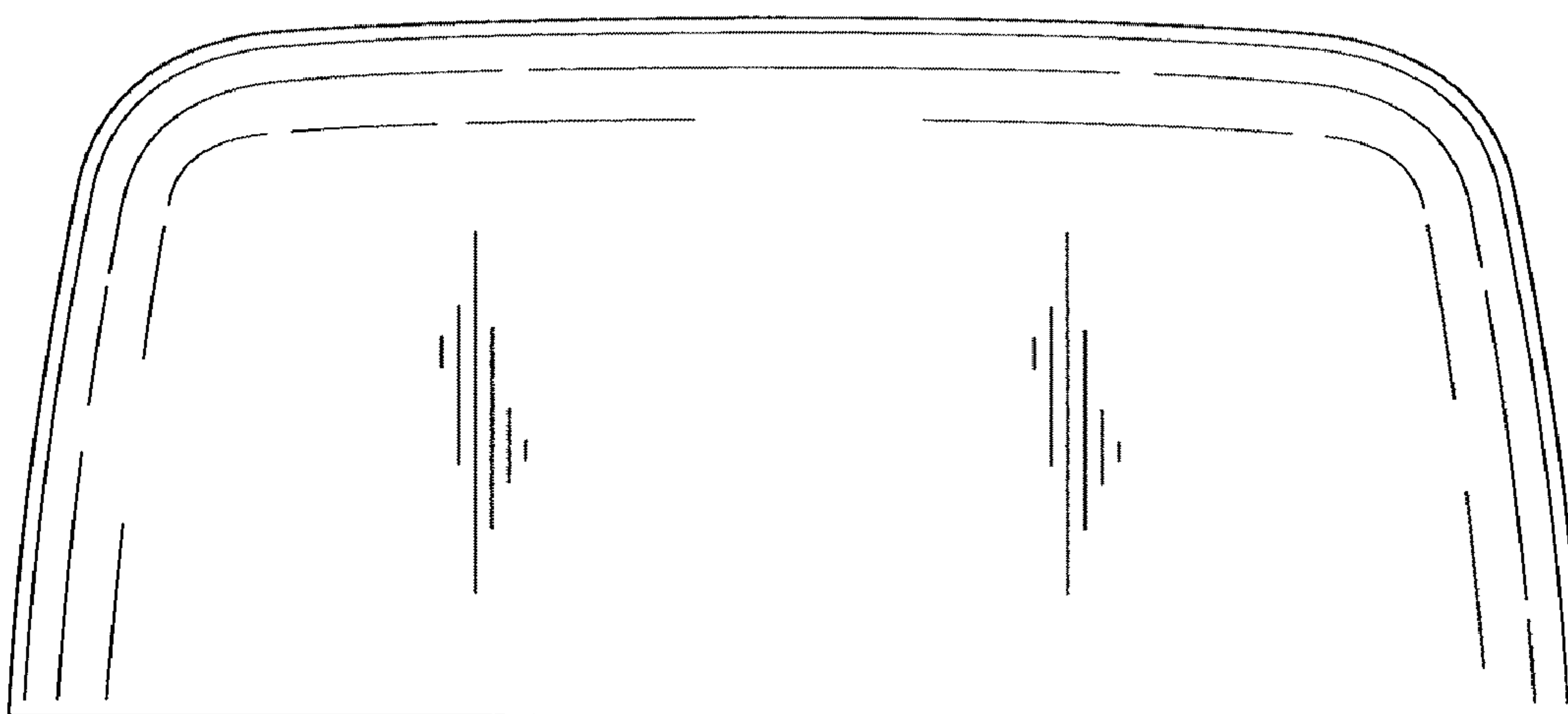

FIG. 3

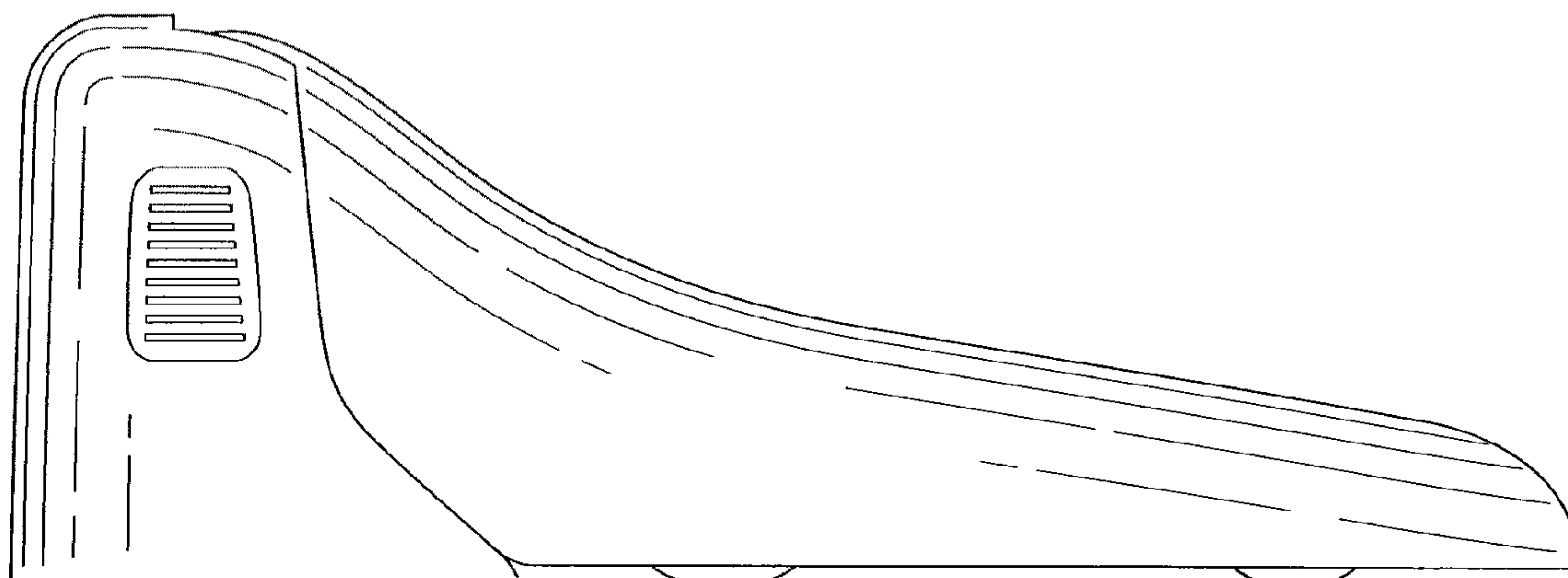

FIG. 4

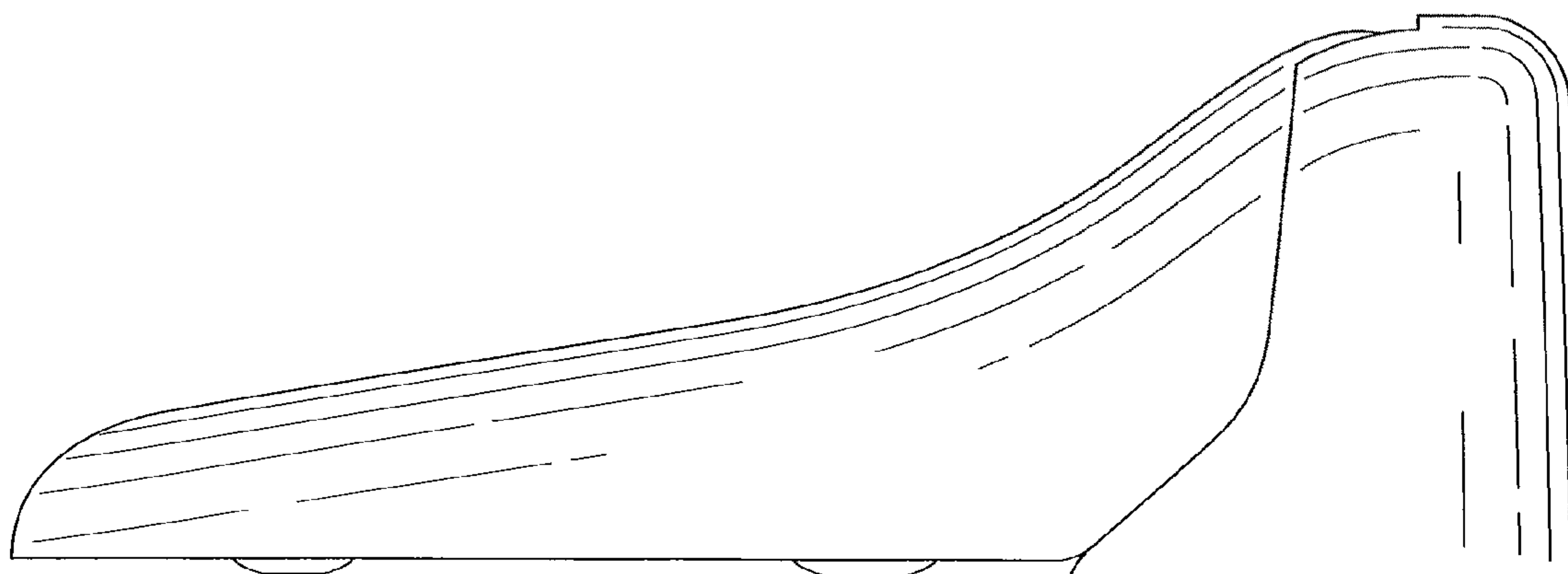

FIG. 5

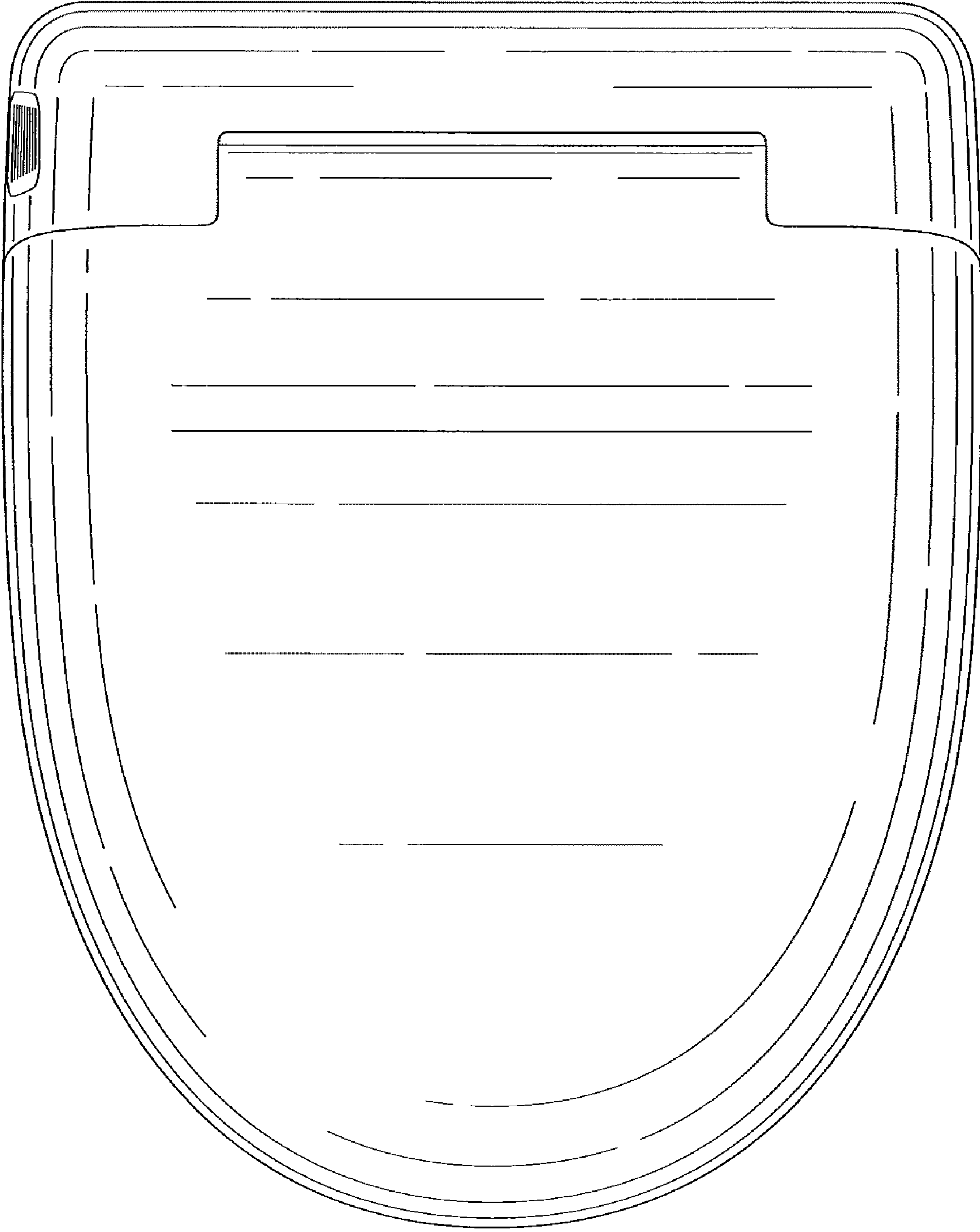

FIG. 6

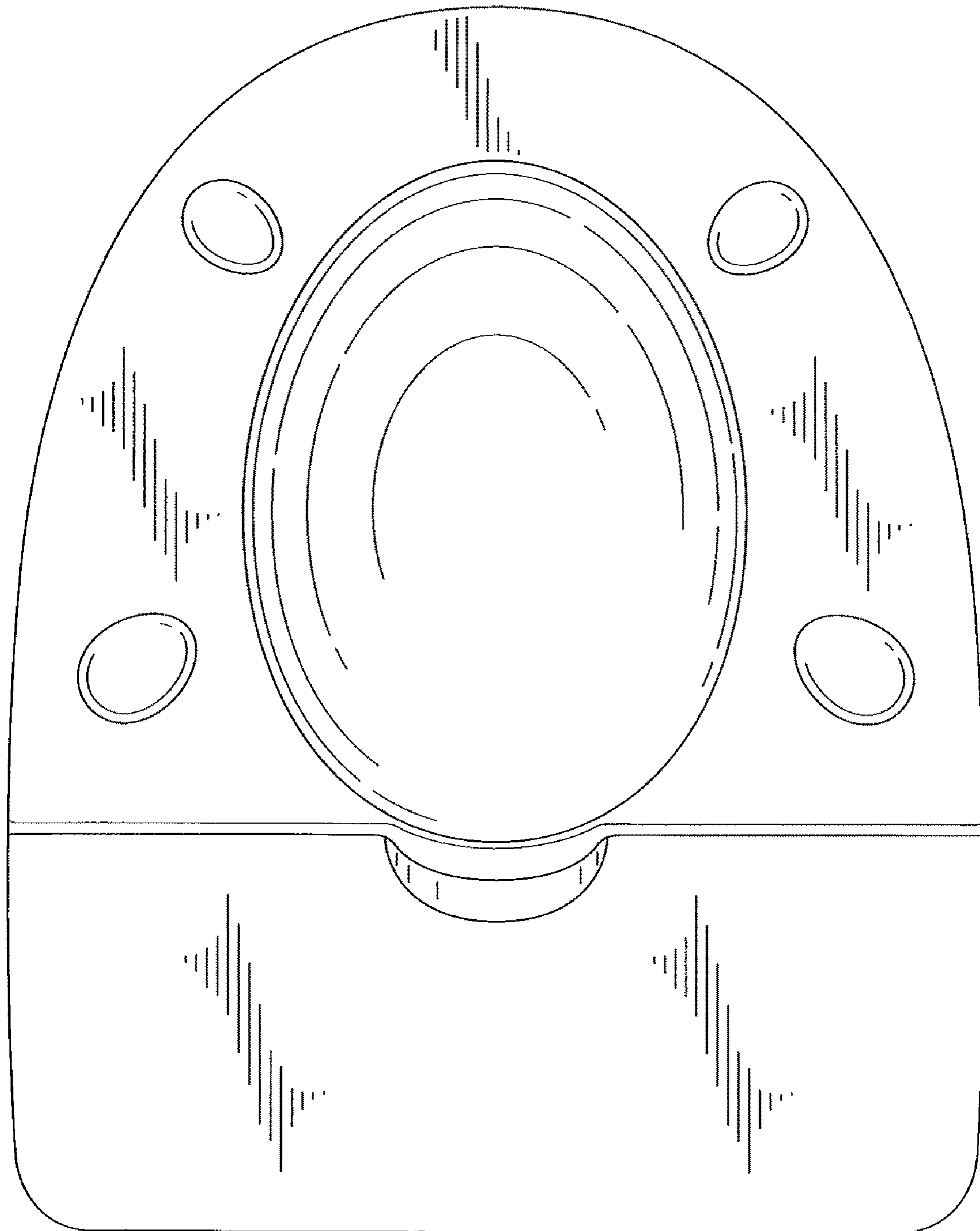

FIG. 7