



US00D620444S

(12) **United States Design Patent**
Liu et al.

(10) **Patent No.:** **US D620,444 S**
(45) **Date of Patent:** **** Jul. 27, 2010**

(54) **RECEPTACLE CONNECTOR**

D587,655 S * 3/2009 Chiang D13/147

(75) Inventors: **Fei Liu**, Guang-Dong (CN); **Ou Yang**,
Guang-Dong (CN); **Hong-Tu Zhang**,
Guang-Dong (CN); **Ping-Chih Chen**,
Tu-Cheng (TW); **Ming-Chiang Chen**,
Tu-Cheng (TW)

* cited by examiner

Primary Examiner—Daniel D Bui
(74) *Attorney, Agent, or Firm*—Cheng-Ju Chiang

(73) Assignee: **Cheng Uei Precision Industry Co.,
Ltd.**, Tu-Cheng, Taipei Hsien (TW)

(57) **CLAIM**

The ornamental design for a receptacle connector, as shown
and described.

(**) Term: **14 Years**

DESCRIPTION

(21) Appl. No.: **29/352,062**

FIG. 1 is a front, top and right side perspective view of a
receptacle connector showing our new design;

(22) Filed: **Dec. 15, 2009**

FIG. 2 is a front elevational view thereof;

(51) **LOC (9) Cl.** **13-03**

FIG. 3 is a rear elevational view thereof;

(52) **U.S. Cl.** **D13/147**

FIG. 4 is a left side elevational view thereof;

(58) **Field of Classification Search** D13/147,
D13/154, 184; 439/79, 108, 378, 567, 607-610,
439/668, 680

FIG. 5 is a right side elevational view thereof;

See application file for complete search history.

FIG. 6 is a top plan view thereof;

FIG. 7 is a bottom plan view thereof; and,

FIG. 8 is a rear, bottom and right side perspective view of a
receptacle connector showing our new design.

The broken line portion of the figure drawings is included to
show unclaimed subject matter only and forms no part of the
claimed design.

(56) **References Cited**

U.S. PATENT DOCUMENTS

D367,040 S *	2/1996	Hamada	D13/147
D522,460 S *	6/2006	Chiang et al.	D13/147
D583,328 S *	12/2008	Chiang	D13/147
D583,767 S *	12/2008	Chiang	D13/147

1 Claim, 8 Drawing Sheets

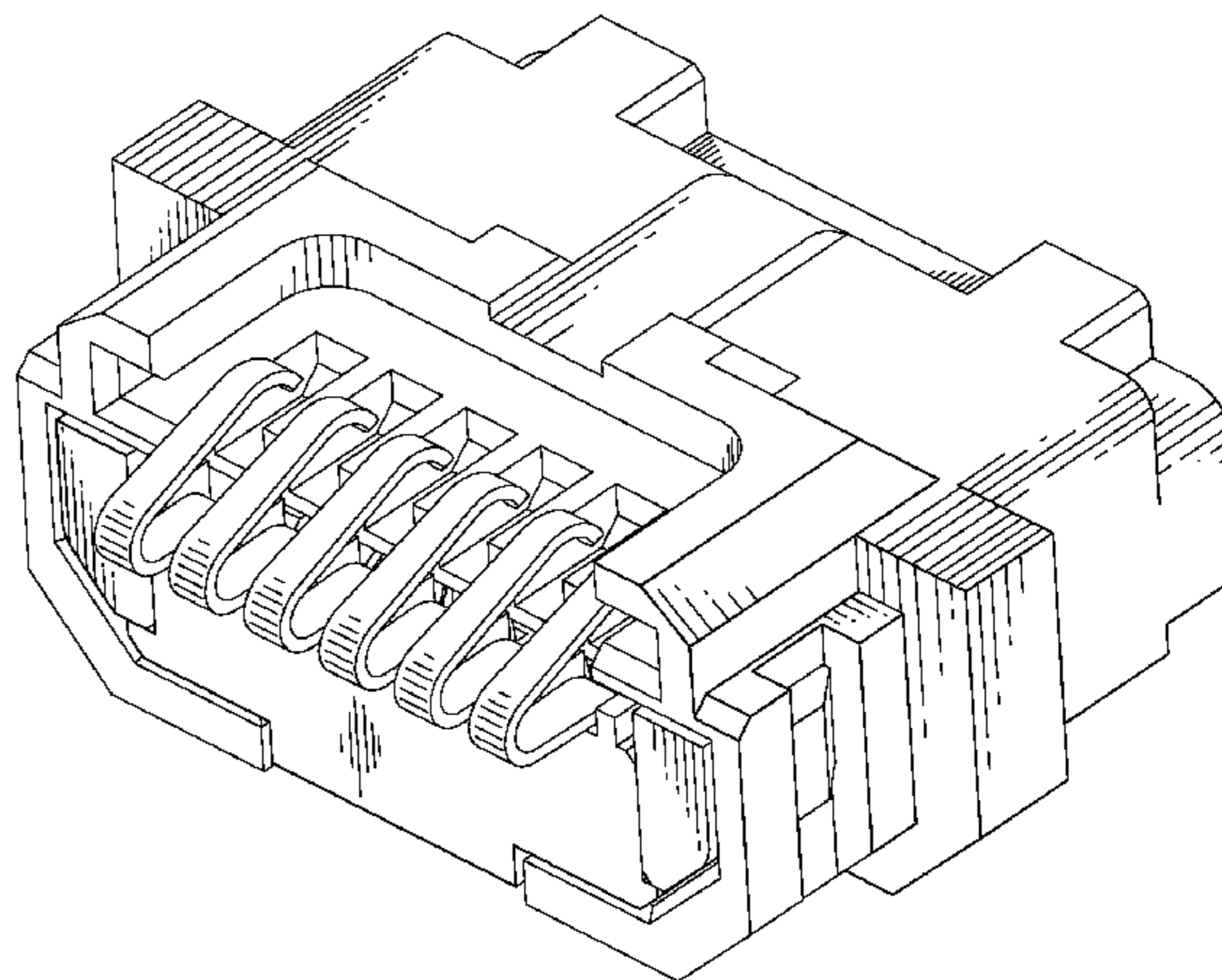
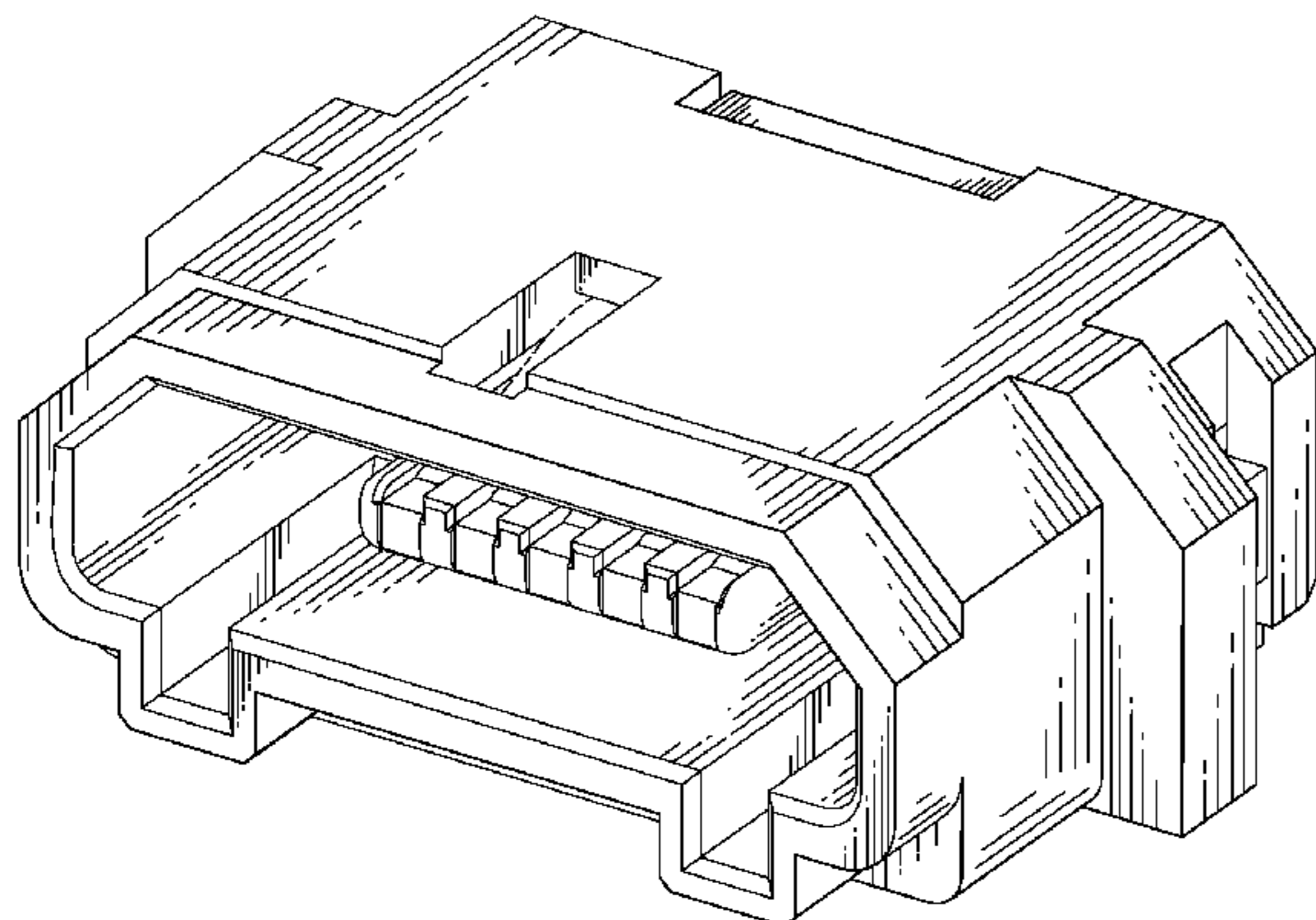

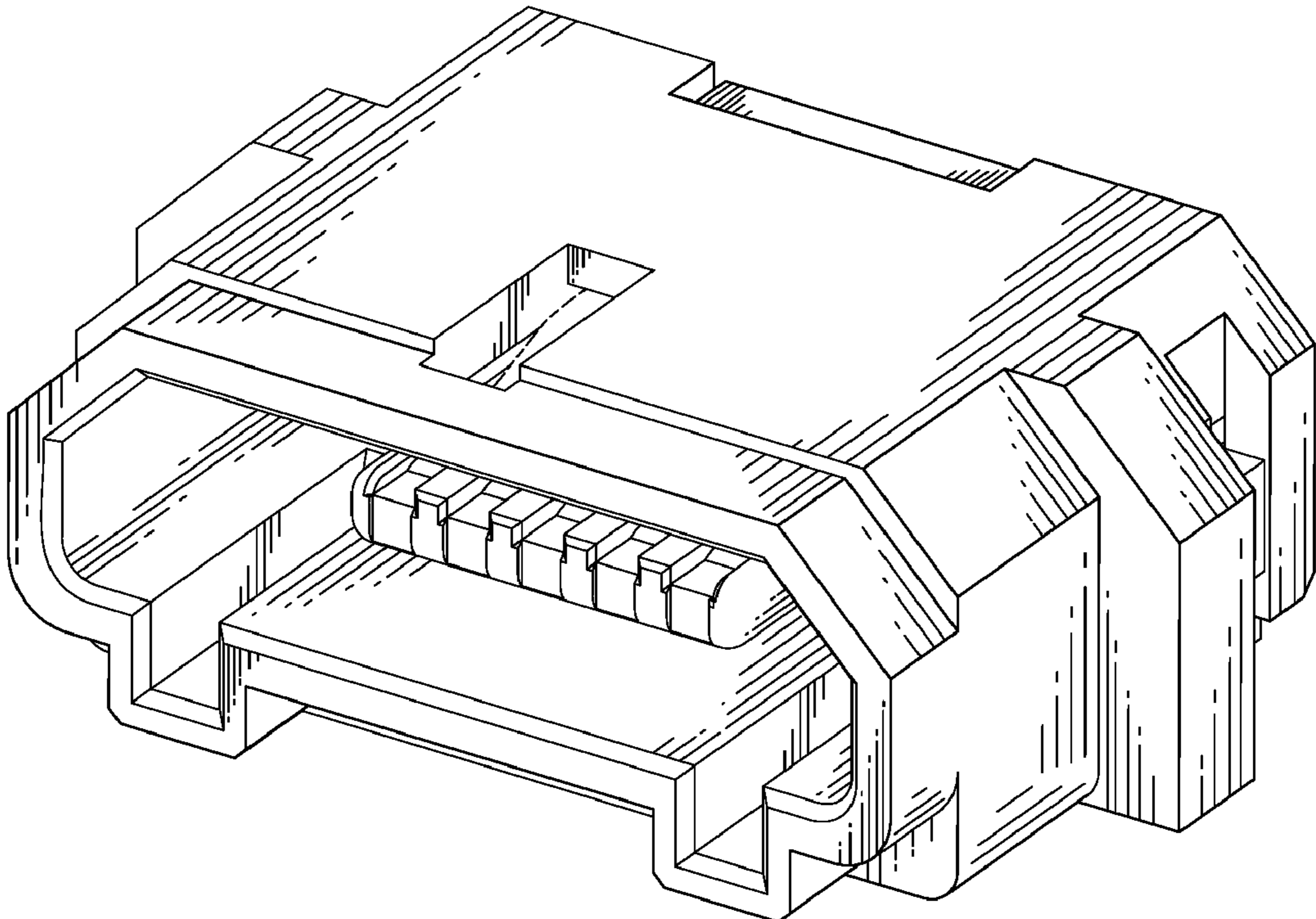

FIG. 1

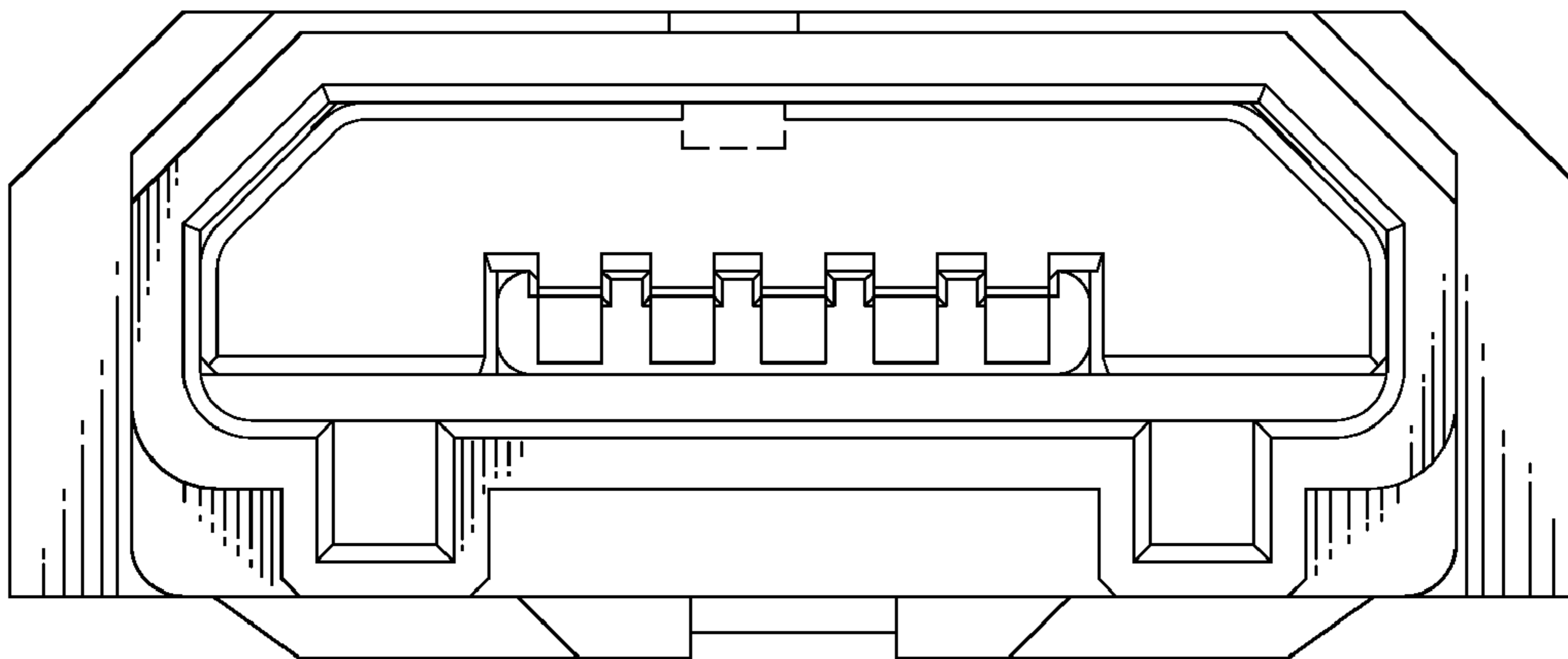

FIG. 2

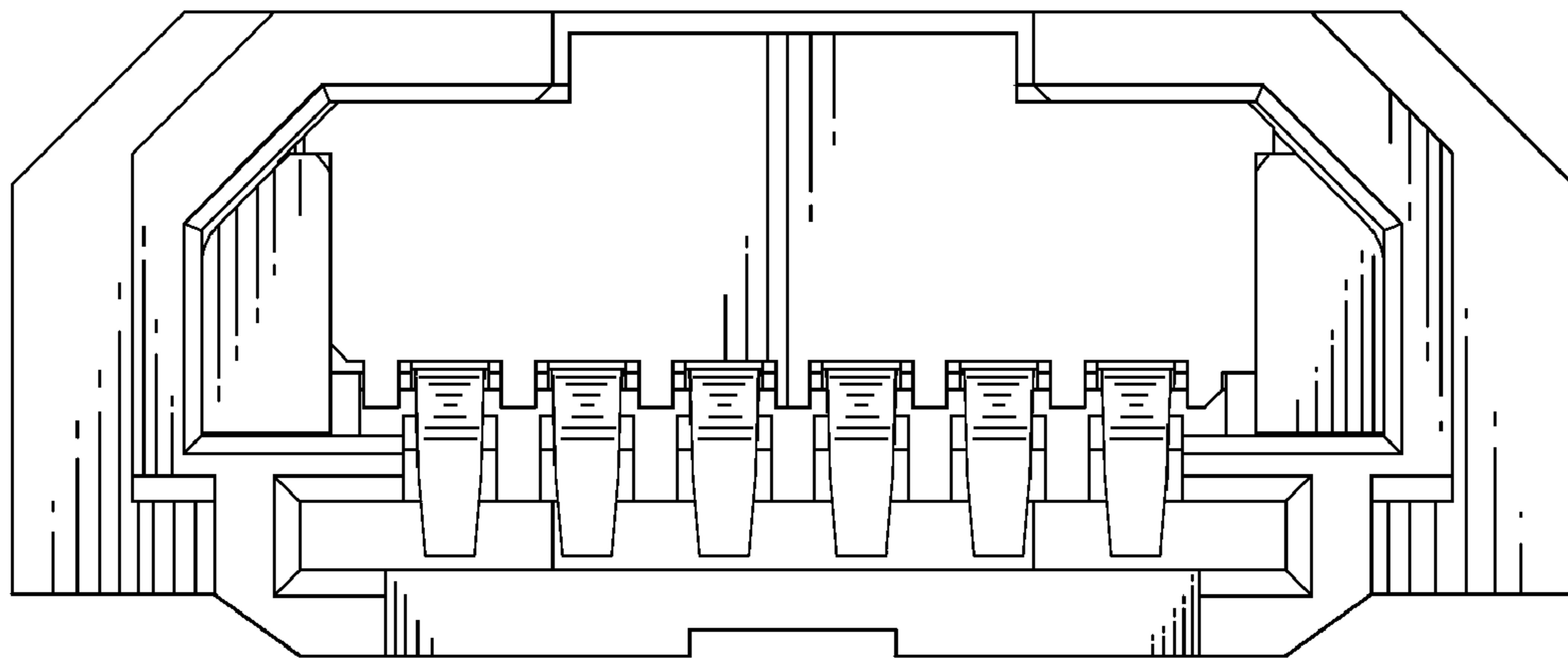

FIG. 3

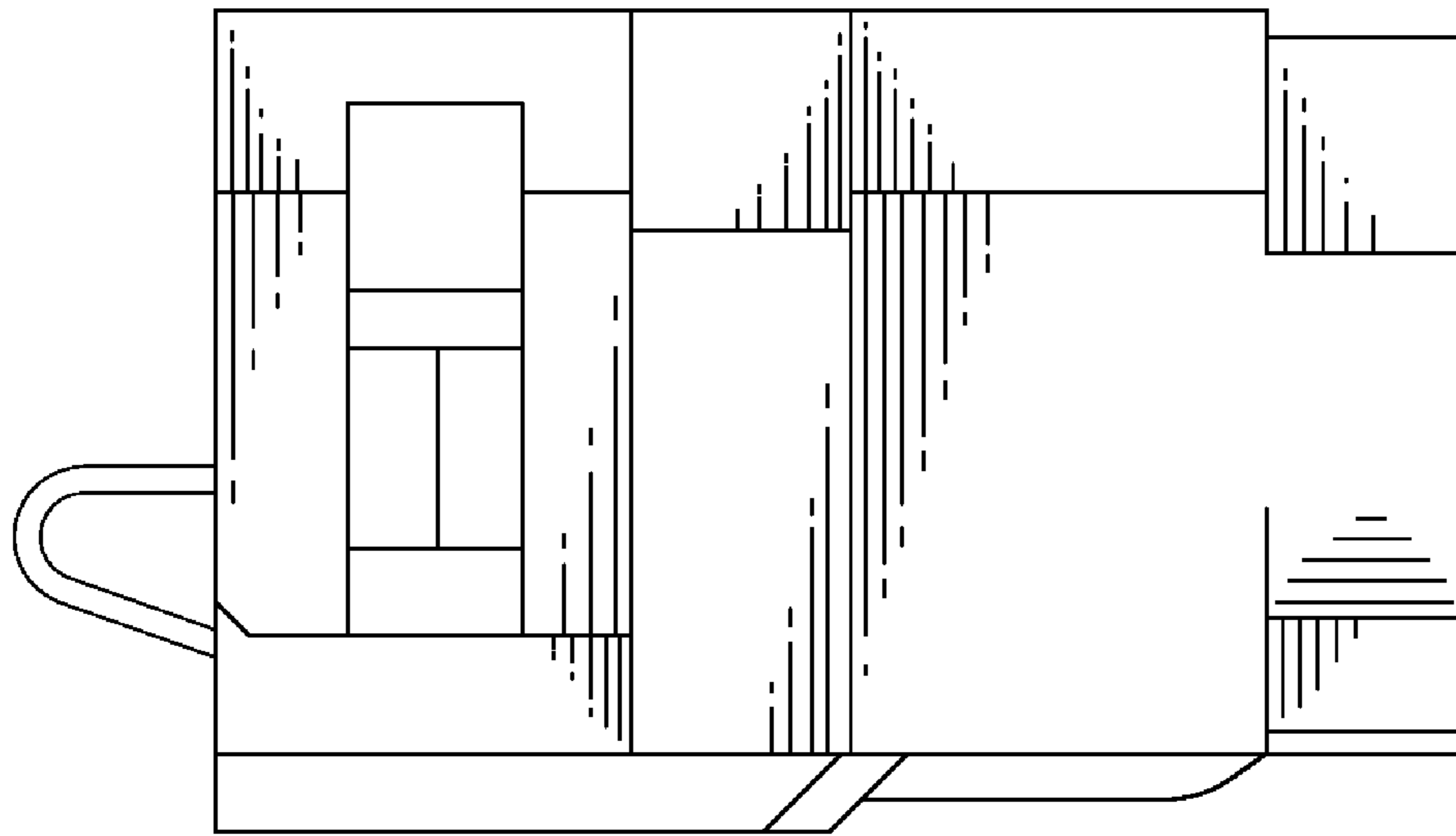

FIG. 4

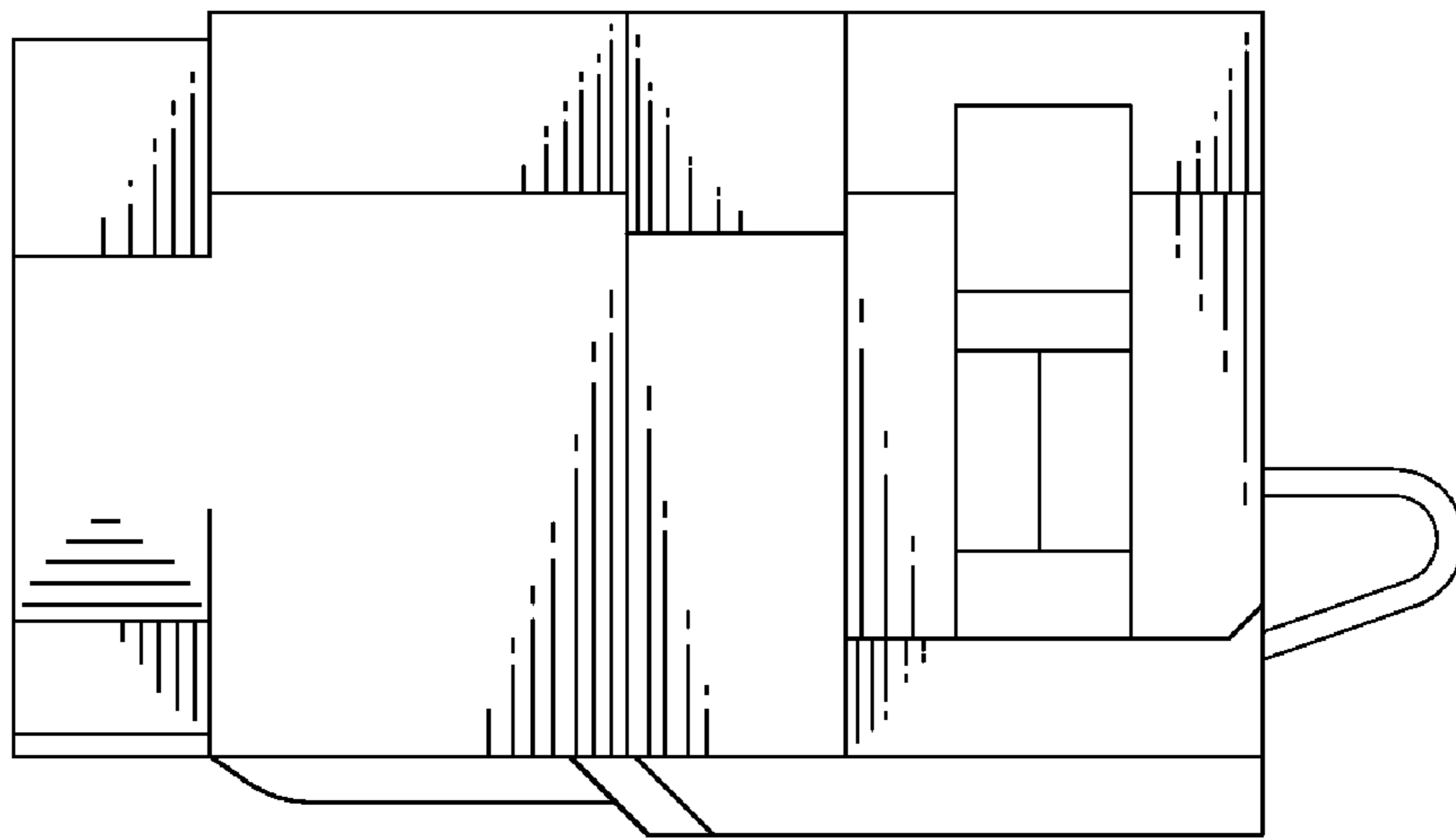

FIG. 5

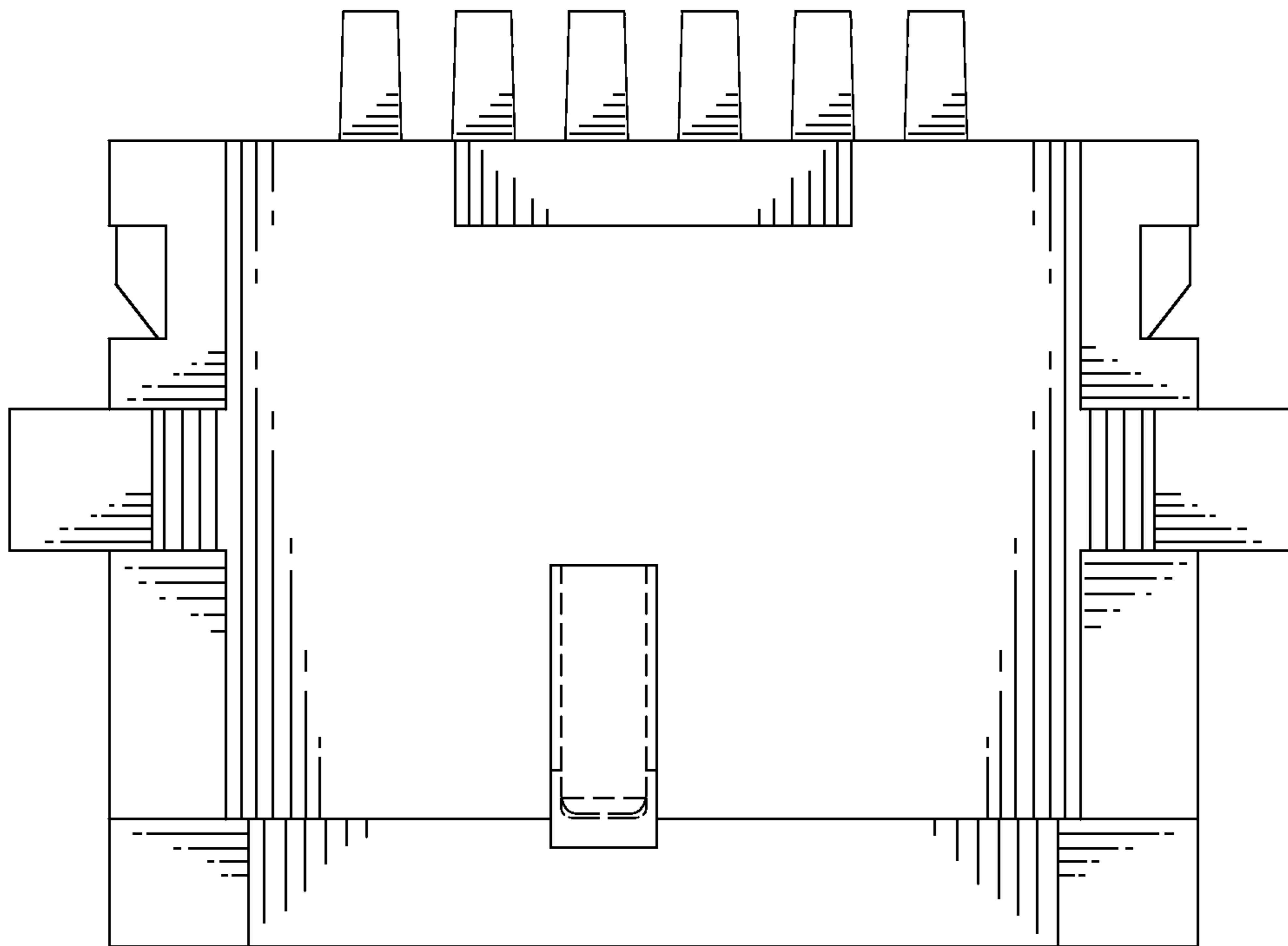

FIG. 6

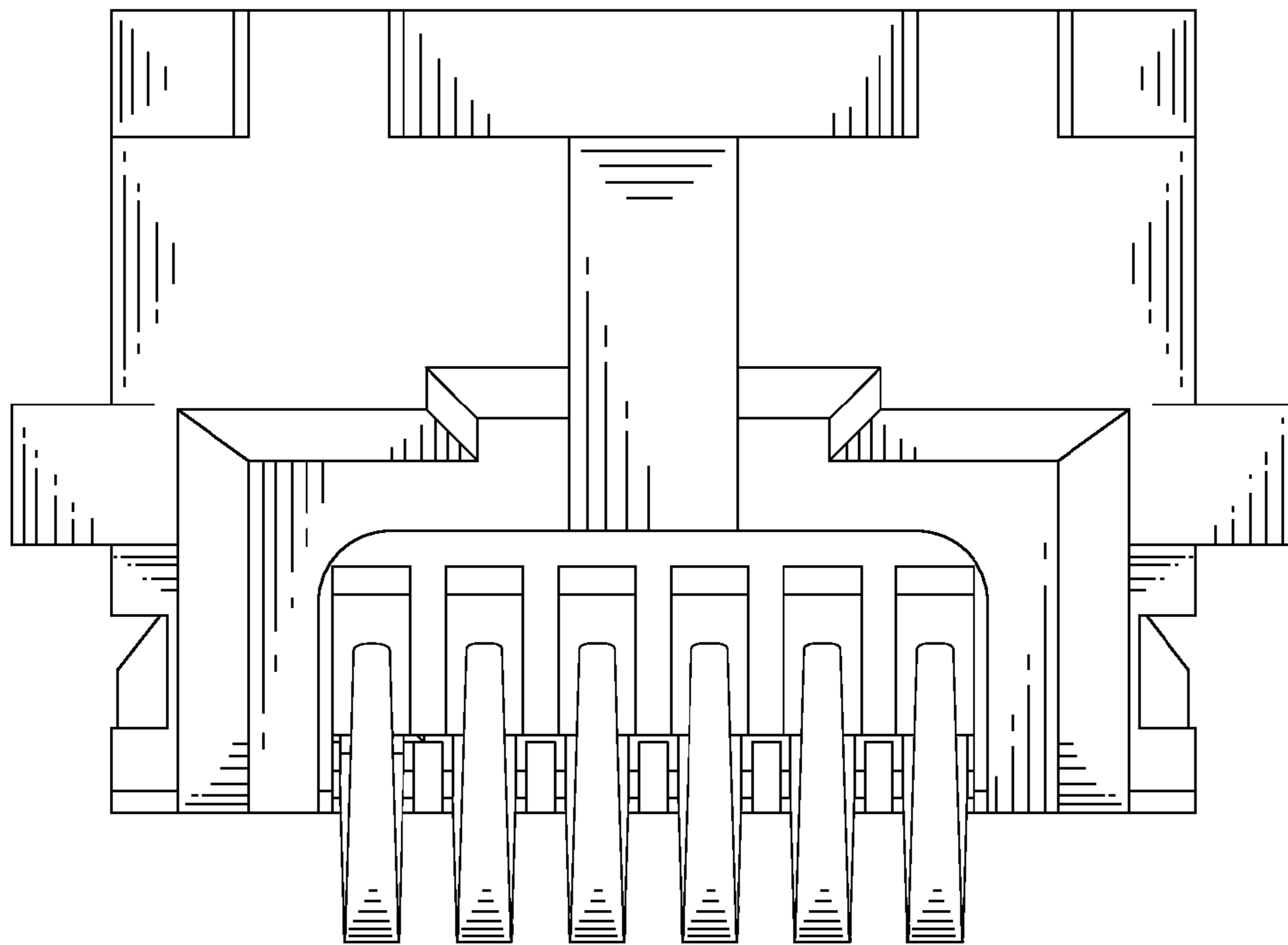

FIG. 7

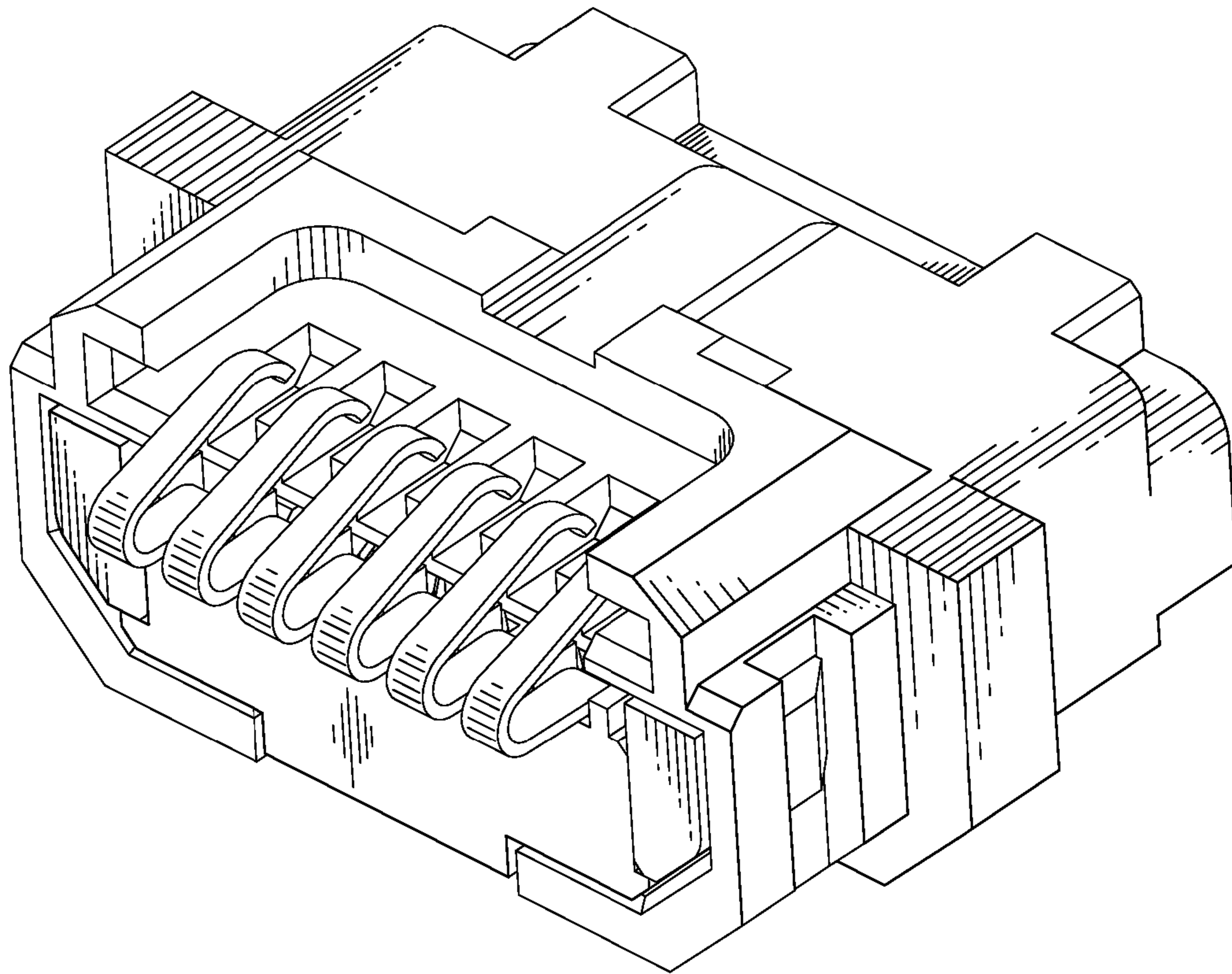

FIG. 8