



US00D620435S

(12) **United States Design Patent**
Yang et al.

(10) **Patent No.:** **US D620,435 S**
(45) **Date of Patent:** **** Jul. 27, 2010**

(54) **BATTERY CONNECTOR**

(75) Inventors: **Bing-Tao Yang**, Guang-Dong (CN);
Yin-Lung Wu, Tu-Cheng (TW);
Ming-Chiang Chen, Tu-Cheng (TW)

(73) Assignee: **Cheng Uei Precision Industry Co., Ltd.**, Tu-Cheng, Taipei Hsien (TW)

(**) Term: **14 Years**

(21) Appl. No.: **29/352,244**

(22) Filed: **Dec. 17, 2009**

(51) **LOC (9) Cl.** **13-03**

(52) **U.S. Cl.** **D13/120**

(58) **Field of Classification Search** D13/118–121,
D13/133, 146–147, 154, 184, 199; 439/83,
439/108, 166, 500, 577, 607–610, 630, 650,
439/660, 680, 700, 732, 773.1, 844–845,
439/849–850, 862, 865–867, 870, 872, 877,
439/884–885, 887–891, 907

See application file for complete search history.

(56) **References Cited**

U.S. PATENT DOCUMENTS

5,266,046 A * 11/1993 Bogiel 439/290
D409,143 S * 5/1999 Yoshiura D13/133
D410,226 S * 5/1999 Yoshiura D13/133
D434,375 S * 11/2000 Kawamoto D13/133

D516,039 S * 2/2006 Lei et al. D13/154
D517,019 S * 3/2006 Yao et al. D13/154
D553,573 S * 10/2007 Kondas D13/149
D555,093 S * 11/2007 Chien et al. D13/133
D569,802 S * 5/2008 Long et al. D13/133
D572,190 S * 7/2008 Chen et al. D13/120
D572,191 S * 7/2008 Chen et al. D13/120
D582,348 S * 12/2008 Shiu D13/154

* cited by examiner

Primary Examiner—Rosemary K Tarcza

(74) *Attorney, Agent, or Firm*—Cheng-Ju Chiang

(57) **CLAIM**

The ornamental design for a battery connector, as shown and described.

DESCRIPTION

FIG. 1 is a perspective view of a battery connector showing our new design;

FIG. 2 is a front elevational view thereof;

FIG. 3 is a rear elevational view thereof;

FIG. 4 is a left side elevational view thereof;

FIG. 5 is a right side elevational view thereof;

FIG. 6 is a top plan view thereof; and,

FIG. 7 is a bottom plan view thereof.

1 Claim, 7 Drawing Sheets

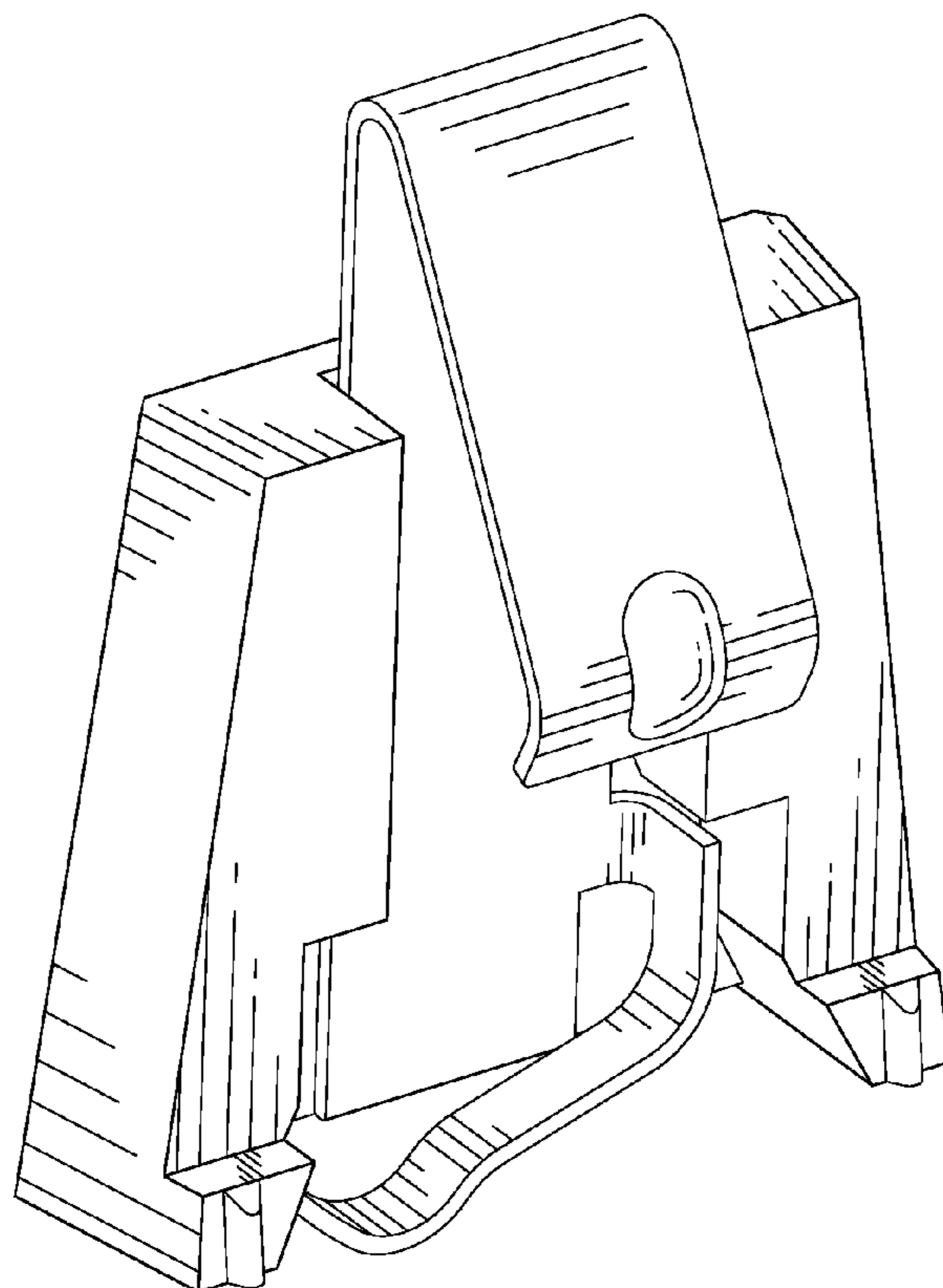

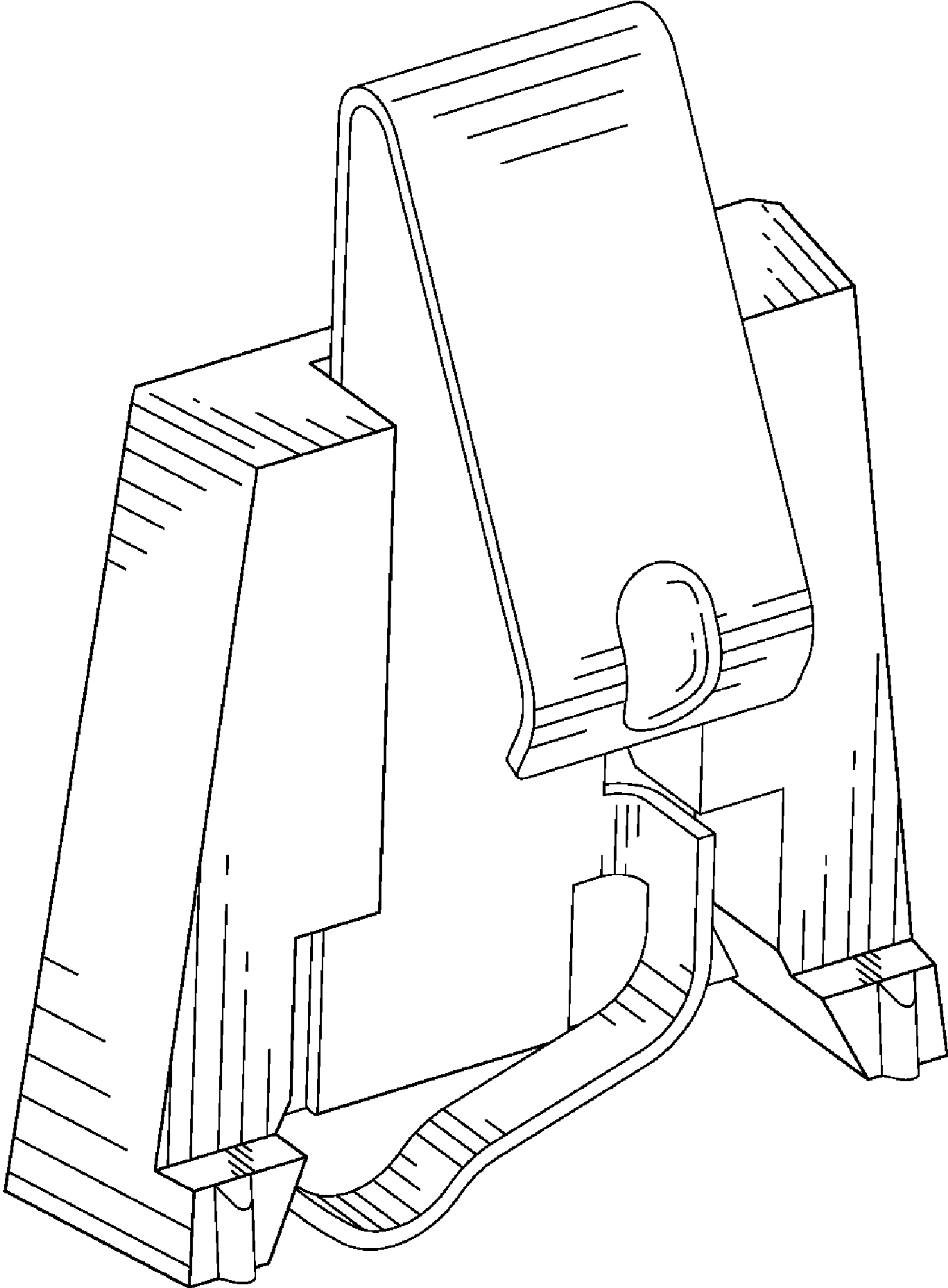

FIG. 1

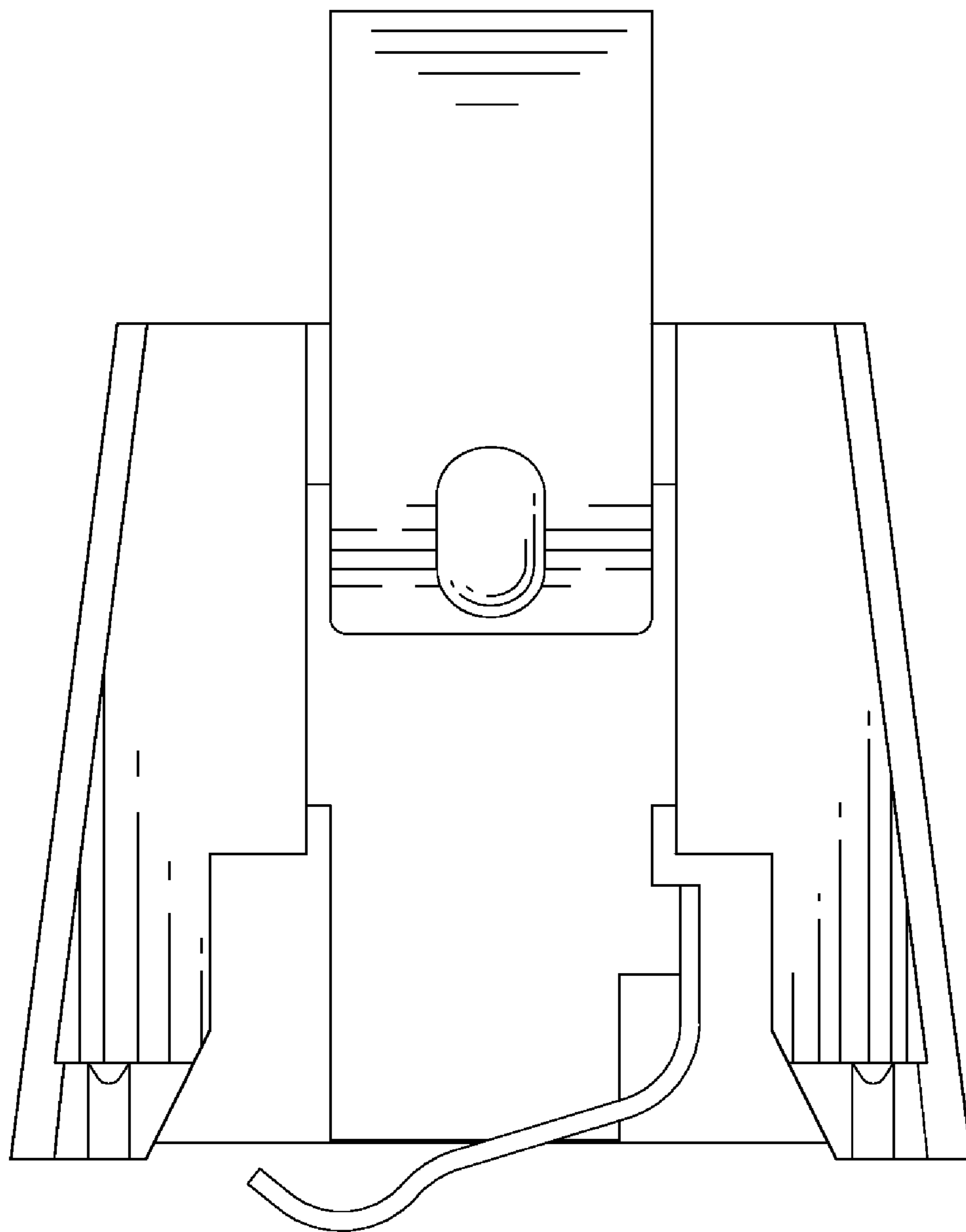

FIG. 2

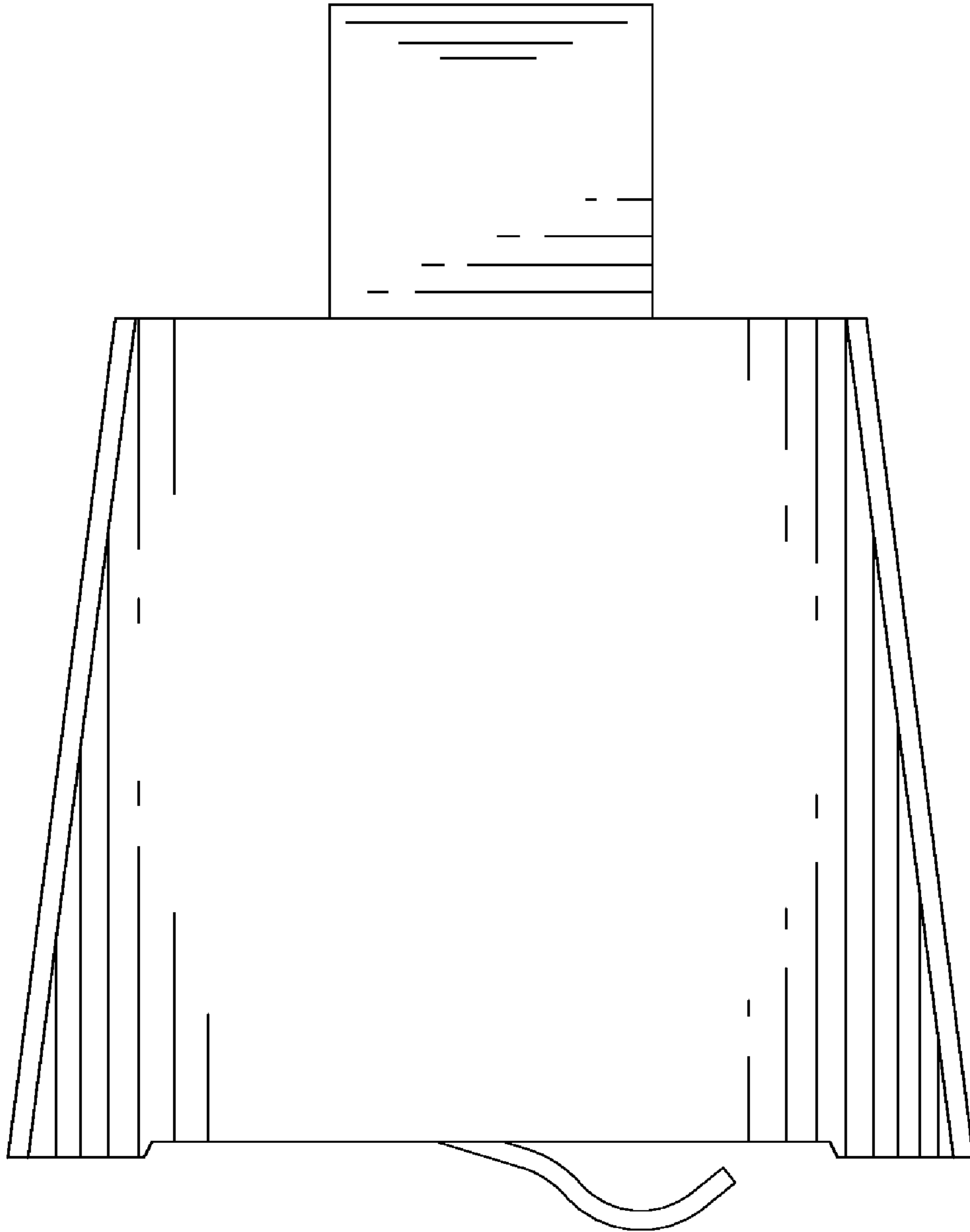

FIG. 3

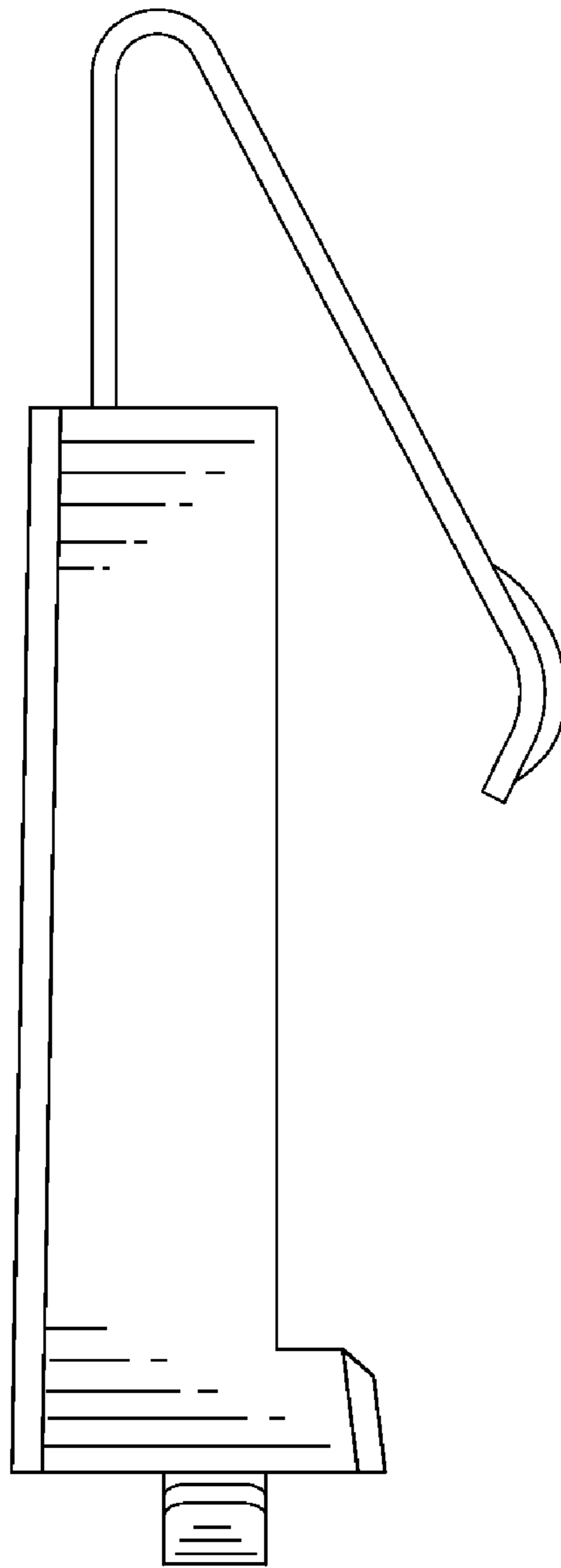

FIG. 4

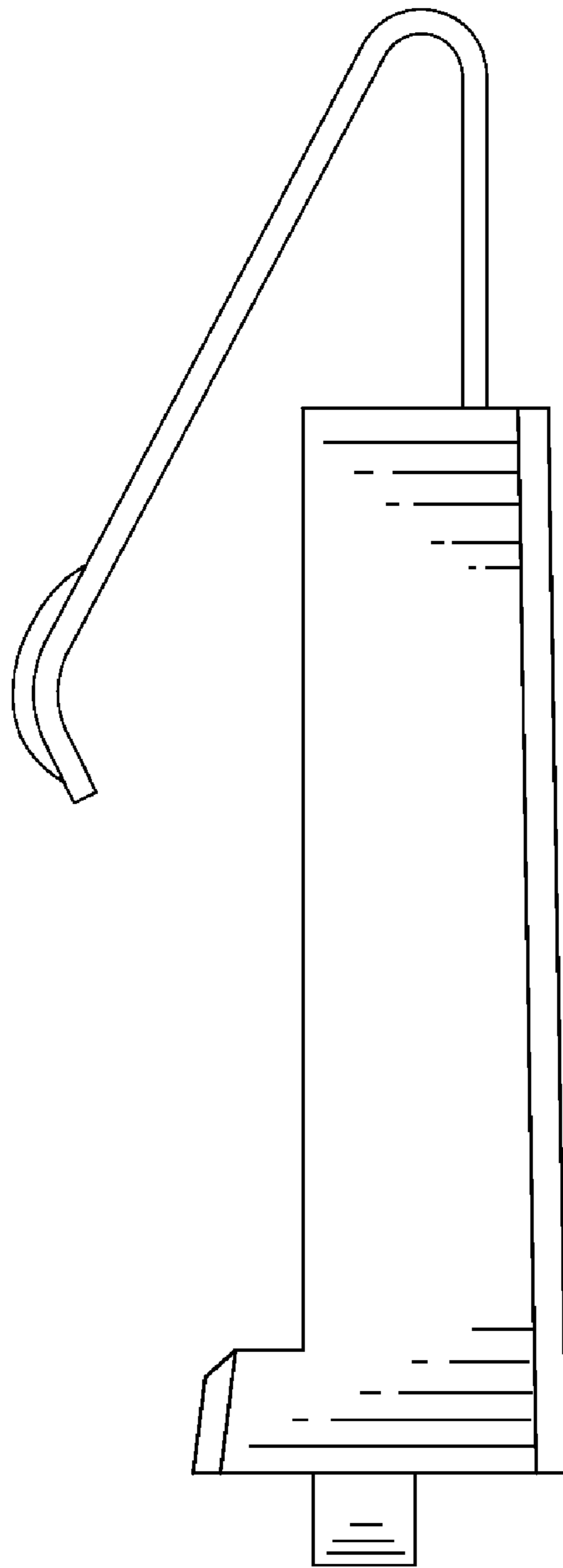

FIG. 5

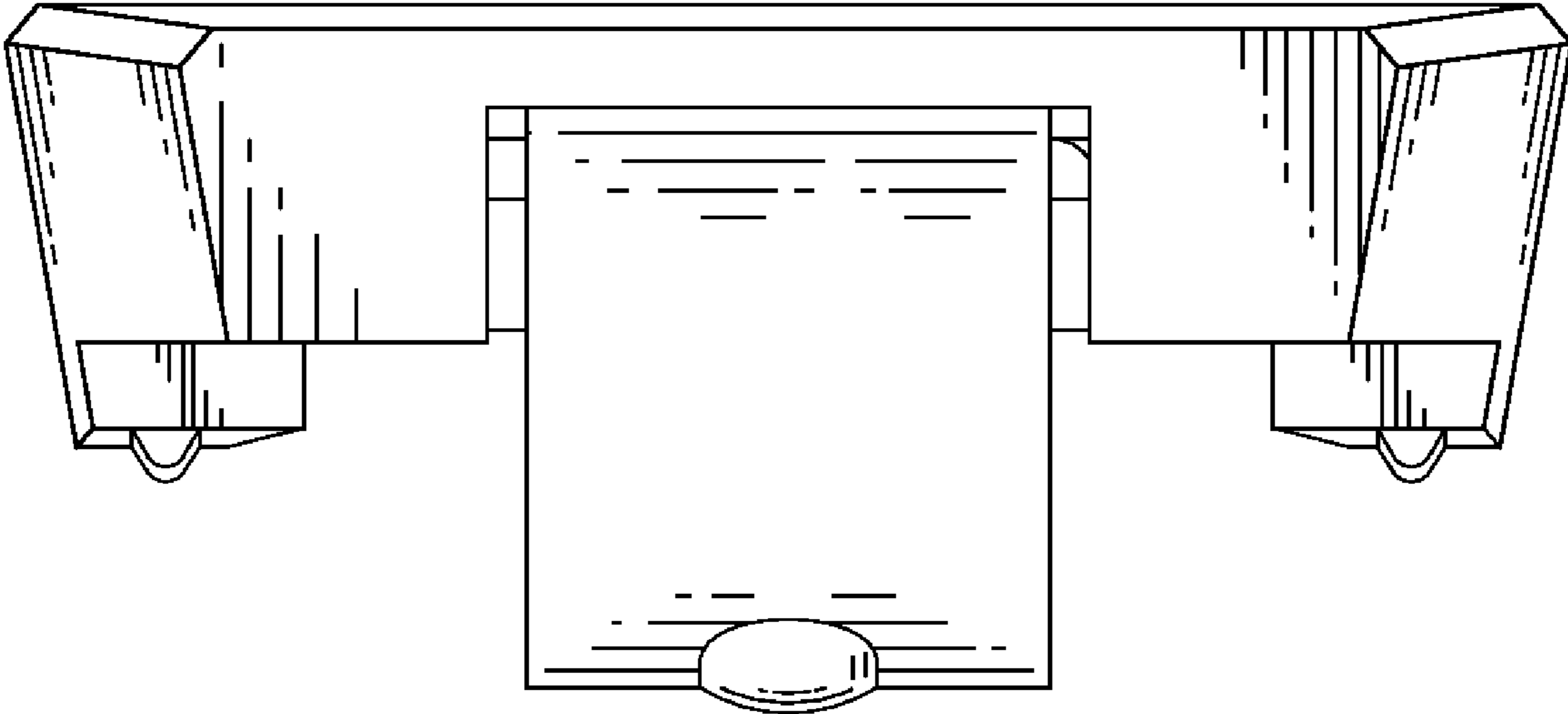

FIG. 6

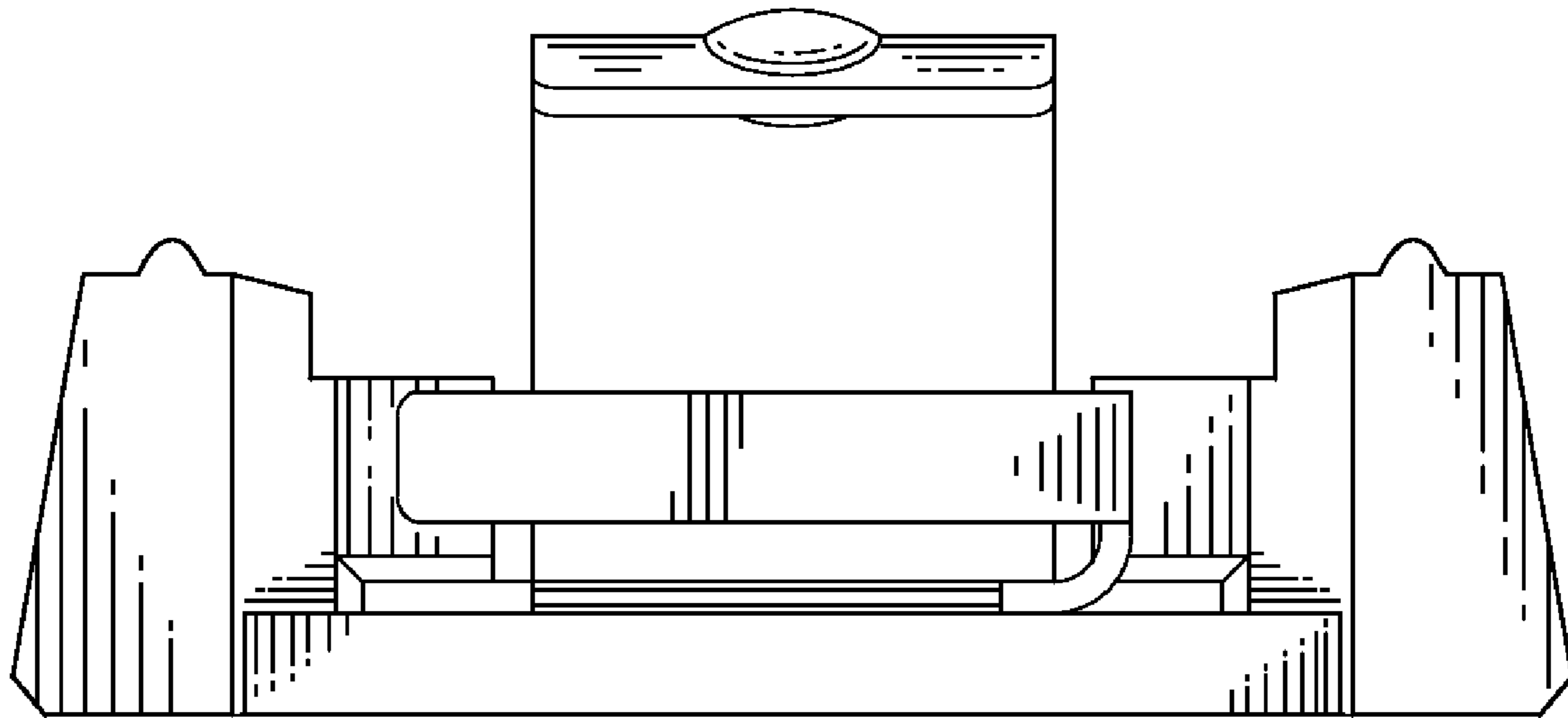

FIG. 7