



US00D620402S

(12) **United States Design Patent**  
**Schwindaman et al.**

(10) **Patent No.:** **US D620,402 S**  
(45) **Date of Patent:** **\*\* Jul. 27, 2010**

- (54) **HYDRAULIC CYLINDER UNIT**
- (75) Inventors: **Michael A. Schwindaman**, Cassopolis, MI (US); **Thomas J. Rogers**, Cassopolis, MI (US); **Michael W. Howard**, Elkhart, IN (US)
- (73) Assignee: **Lippert Components Manufacturing, Inc.**, Goshen, IN (US)

D408,420 S \* 4/1999 Buter ..... D15/7  
 6,044,752 A 4/2000 Harigaya  
 6,089,603 A 7/2000 Ackley  
 6,415,876 B1 7/2002 Bollinger et al.  
 6,637,315 B2 10/2003 Mickelson  
 D500,258 S \* 12/2004 Kita et al. .... D10/85  
 6,896,289 B2 \* 5/2005 Gross ..... 280/766.1  
 7,066,223 B2 \* 6/2006 Stone ..... 144/195.1  
 7,296,784 B2 11/2007 Peter

- (\*\*) Term: **14 Years**
- (21) Appl. No.: **29/324,878**
- (22) Filed: **Sep. 23, 2008**

**FOREIGN PATENT DOCUMENTS**

WO WO 98/38431 9/1998

\* cited by examiner

*Primary Examiner*—T. Chase Nelson  
*Assistant Examiner*—Michael A Pratt  
 (74) *Attorney, Agent, or Firm*—Barnes & Thornburg LLP

- (51) **LOC (9) Cl.** ..... **12-16**
- (52) **U.S. Cl.** ..... **D12/159**
- (58) **Field of Classification Search** ..... D12/159;  
 D34/31; 280/763.1, 764.1, 765.1, 766.1;  
 254/418, 423; 305/145, 147; 414/708; 299/37.4;  
 298/22 C, 22 J  
 See application file for complete search history.

(57) **CLAIM**

The ornamental design for a hydraulic cylinder unit, as shown and described.

**DESCRIPTION**

FIG. 1 is a perspective view of a hydraulic cylinder unit showing our new design;  
 FIG. 2 is a side view of the design of FIG. 1;  
 FIG. 3 is another side view of the design of FIG. 1;  
 FIG. 4 is a bottom end view of the design of FIG. 1;  
 FIG. 5 is a top end view of the design of FIG. 1;  
 FIG. 6 is a top view of the design of FIG. 1; and,  
 FIG. 7 is a bottom view of the design of FIG. 1.

The broken line showing of (portions of the design shown in broken/dashed lines) is included for the purpose of illustrating environment and forms no part of the claimed design.

**1 Claim, 4 Drawing Sheets**

(56) **References Cited**  
**U.S. PATENT DOCUMENTS**

3,185,043 A	5/1965	Dunham	
3,362,683 A	1/1968	Hansen	
3,614,064 A	10/1971	Bennett	
3,650,182 A	3/1972	Phillips	
3,656,778 A	4/1972	Bristol	
3,857,582 A	12/1974	Hartog	
4,165,861 A	8/1979	Hanser	
4,216,939 A	8/1980	Valdespino	
4,532,151 A	7/1985	Stenlund	
D282,304 S *	1/1986	Bickley	D34/36
4,711,428 A	12/1987	Carpenter	
D295,753 S *	5/1988	LaBair	D15/7
4,815,711 A	3/1989	Bruno et al.	
5,842,911 A	12/1998	Weber	

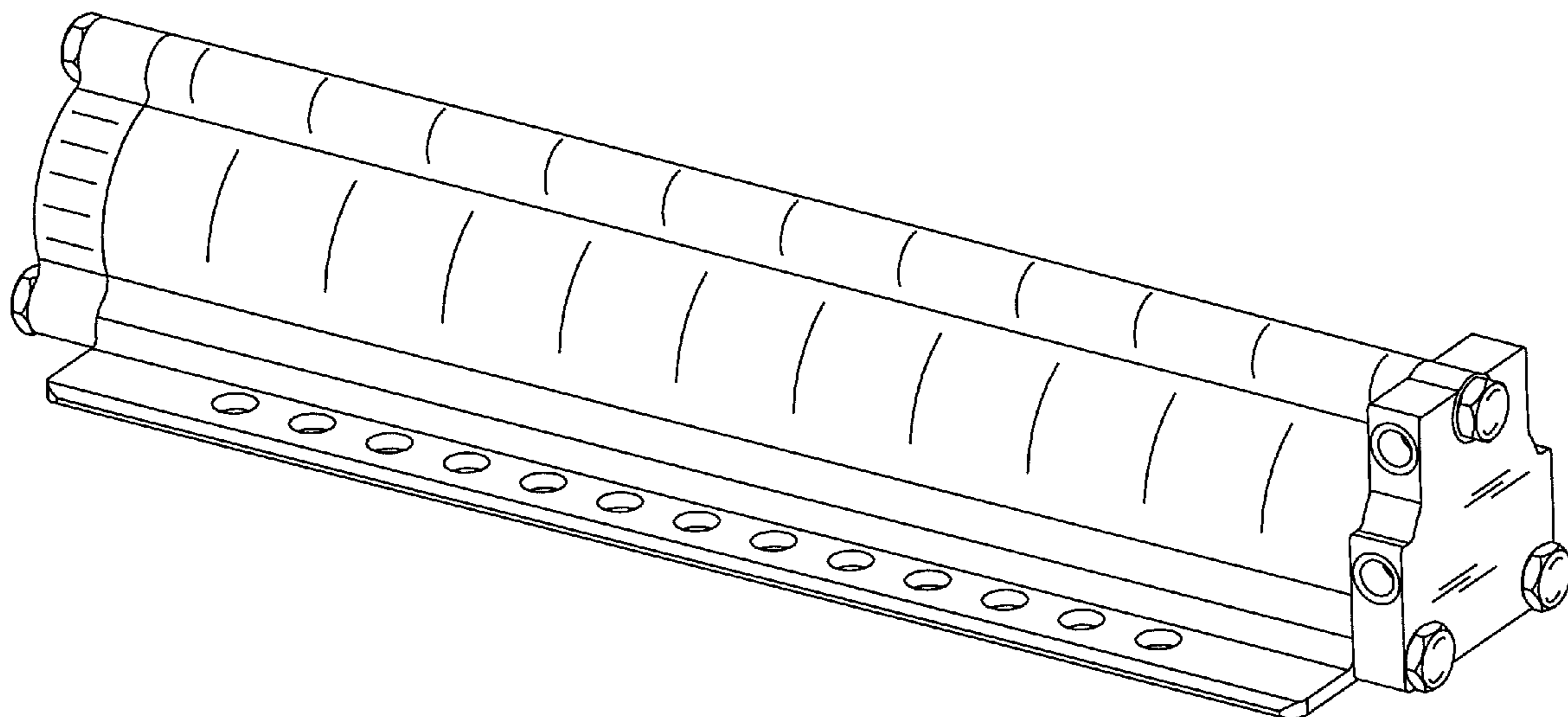

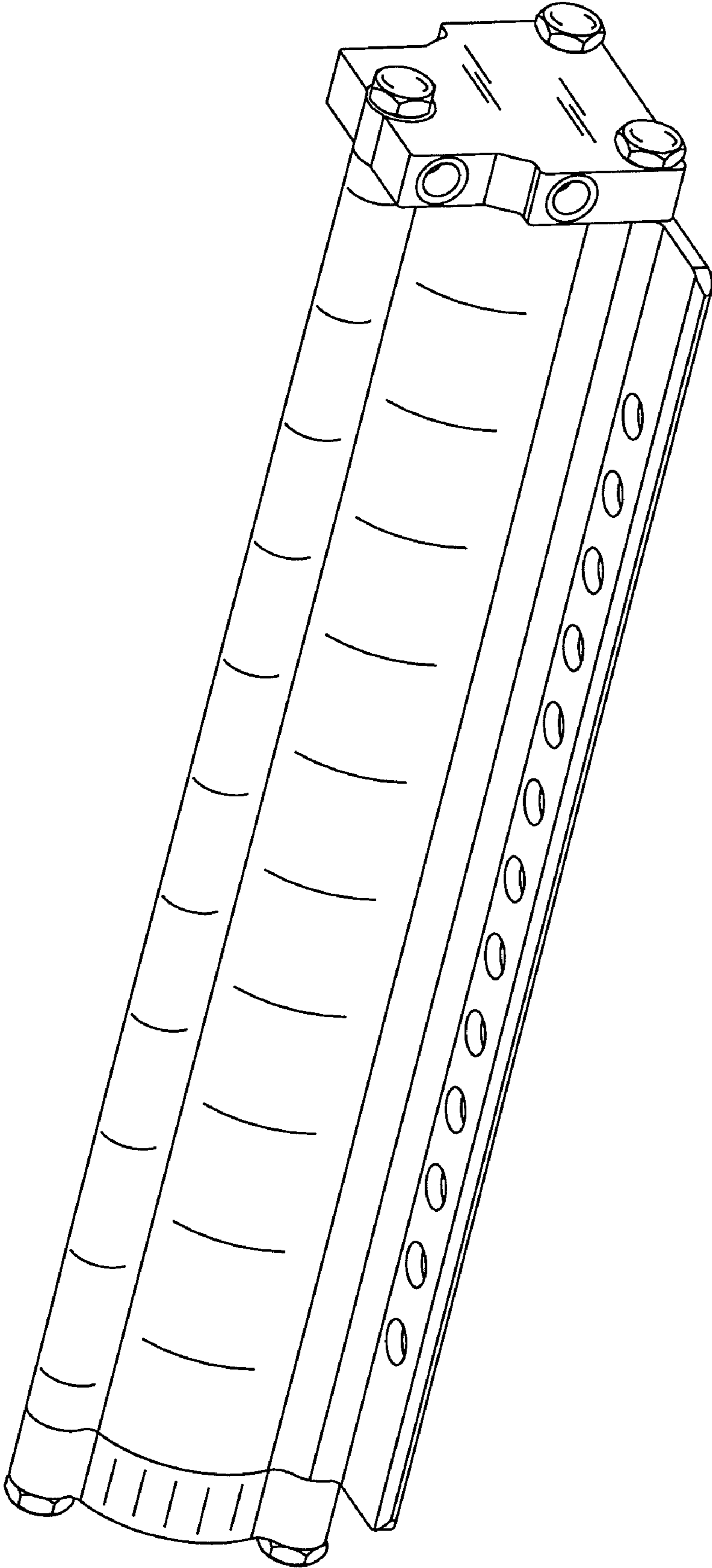

FIG. 1

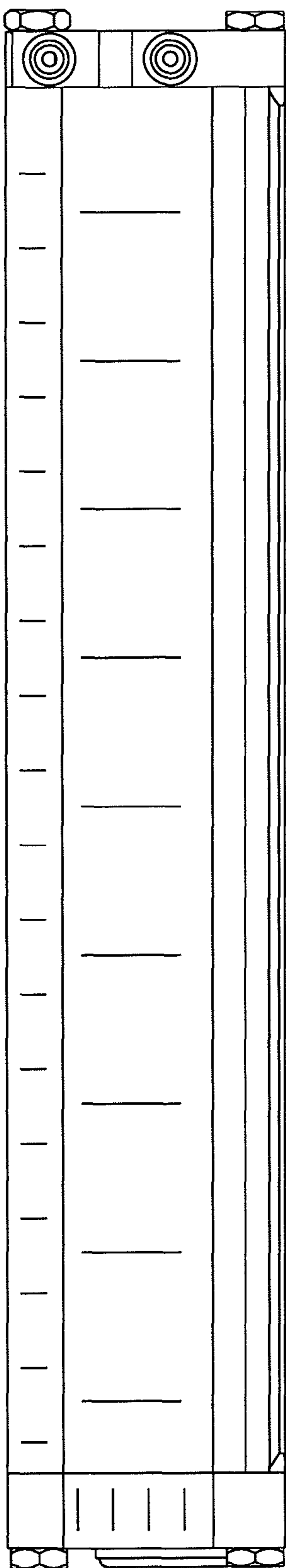

FIG. 2

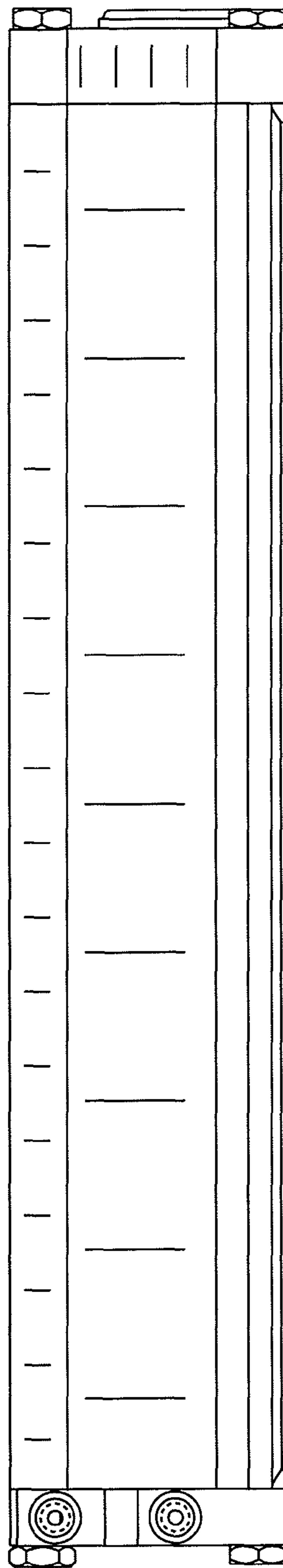

FIG. 3

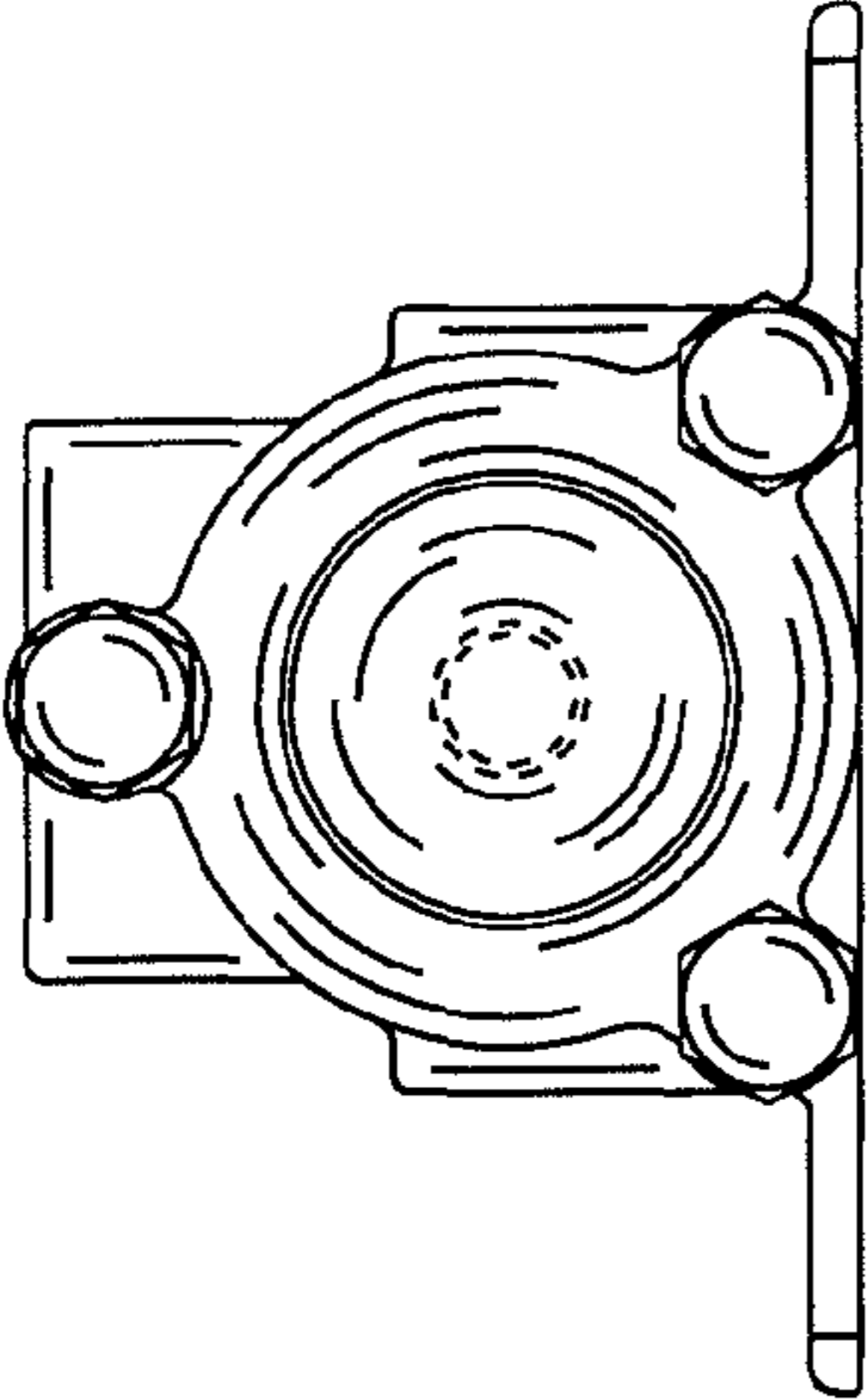

FIG. 4

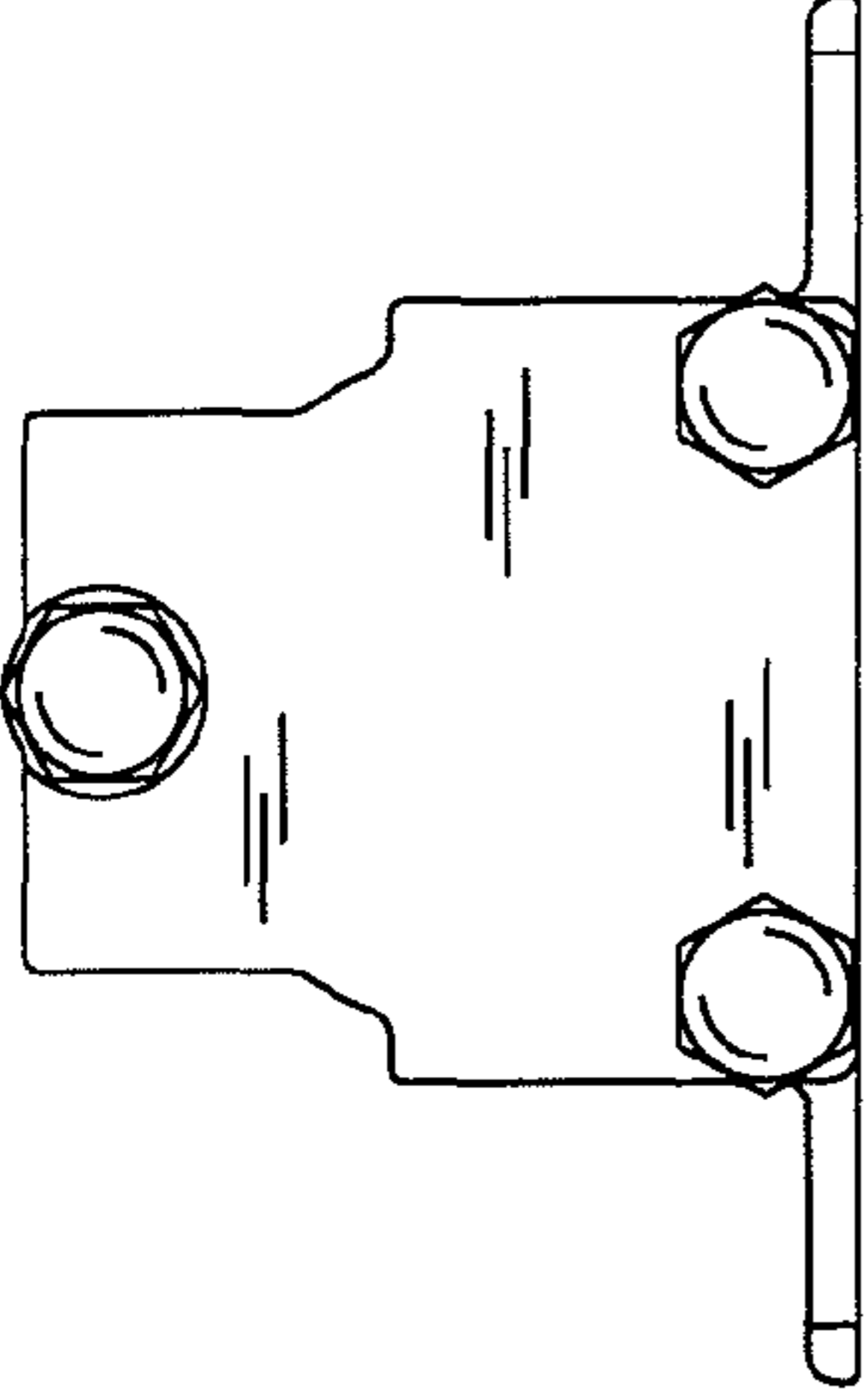

FIG. 5

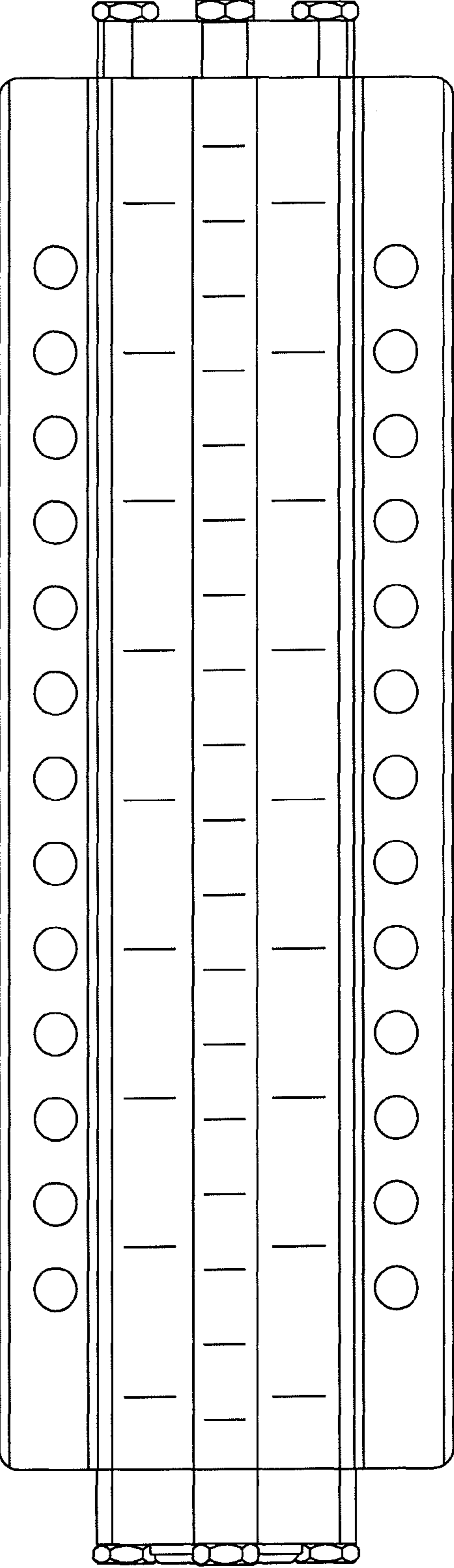

FIG. 6

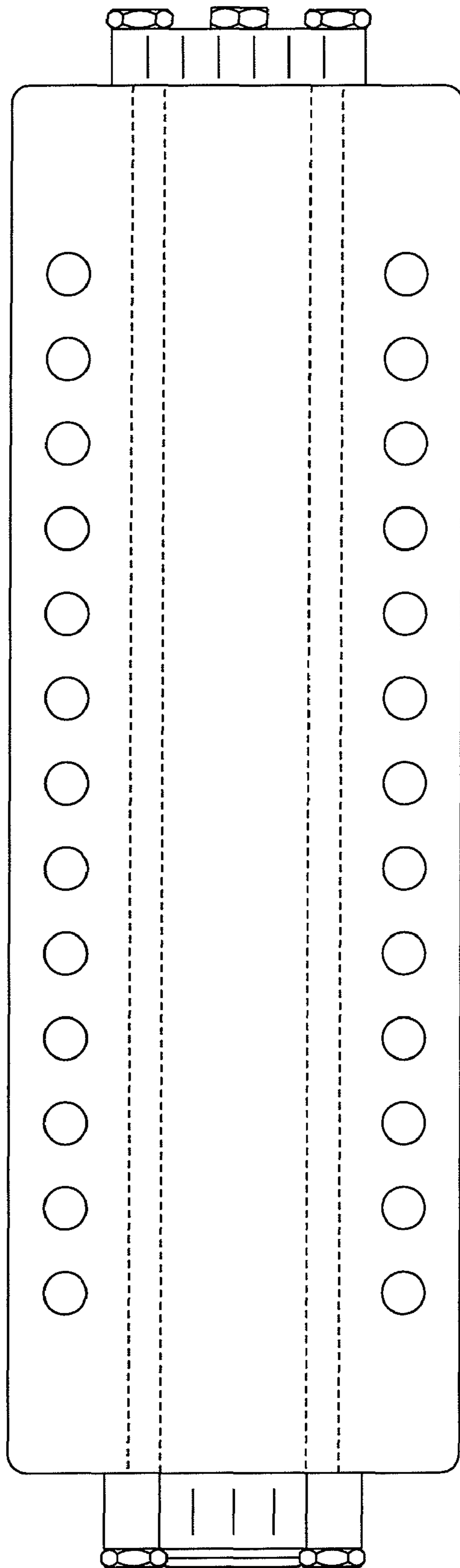

FIG. 7