



US00D620371S

(12) **United States Design Patent**
Bronstein

(10) **Patent No.:** **US D620,371 S**

(45) **Date of Patent:** **** Jul. 27, 2010**

(54) **BOTTLE**

(75) Inventor: **Maayan Bronstein**, Hadera (IL)

(73) Assignee: **Neviot-Nature of Galilee Ltd.**, Lod (IL)

(**) Term: **14 Years**

(21) Appl. No.: **29/340,947**

(22) Filed: **Jul. 28, 2009**

(30) **Foreign Application Priority Data**

Feb. 8, 2009 (IL) 47230

(51) **LOC (9) Cl.** **09-01**

(52) **U.S. Cl.** **D9/667**; D9/551; D9/557

(58) **Field of Classification Search** D7/514-517;
D9/600, 649, 667, 500-504, 516, 520, 537-543,
D9/547, 549-552, 556-558; 206/457, 459.5;
215/379-383, 400; 220/890

See application file for complete search history.

(56) **References Cited**

U.S. PATENT DOCUMENTS

D61,380 S * 8/1922 Ritterbeck D9/646

D126,725 S * 4/1941 Vicent D9/667

D252,852 S * 9/1979 Lang D9/669

D402,562 S * 12/1998 Anderson et al. D9/547

D453,112 S * 1/2002 Macky et al. D9/538

D534,080 S * 12/2006 Mody et al. D9/516

OTHER PUBLICATIONS

www.globalpackagegallery.com Neviot water bottle, Sep. 25, 2006.*

* cited by examiner

Primary Examiner—Sandra Morris

(74) *Attorney, Agent, or Firm*—Hunton & Williams LLP

(57) **CLAIM**

I claim the ornamental design for a bottle, as shown and described.

DESCRIPTION

FIG. 1 depicts a perspective view of a bottle.

FIG. 2 depicts a side elevation view of a bottle.

FIG. 3 depicts a side elevation view of a bottle

FIG. 4 depicts a top plan view of a bottle.

FIG. 5 depicts a bottom plan view of a bottle; and,

FIG. 6 depicts a perspective view of a bottle.

1 Claim, 5 Drawing Sheets

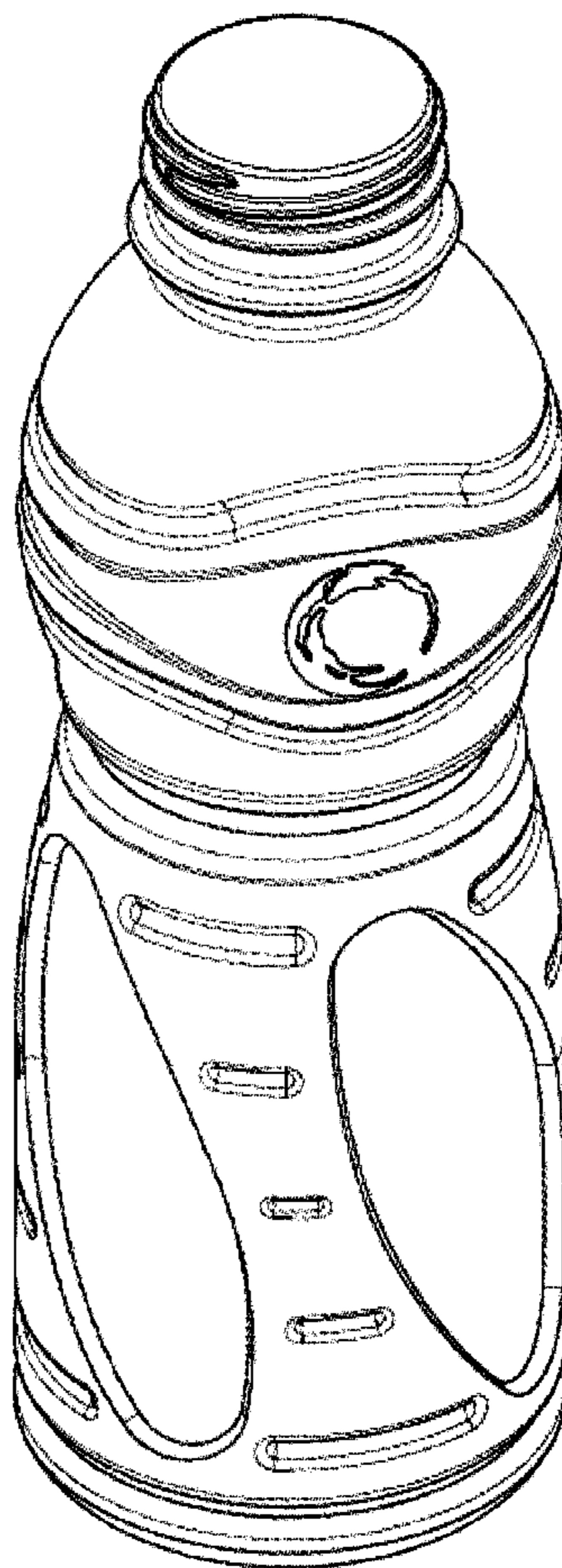

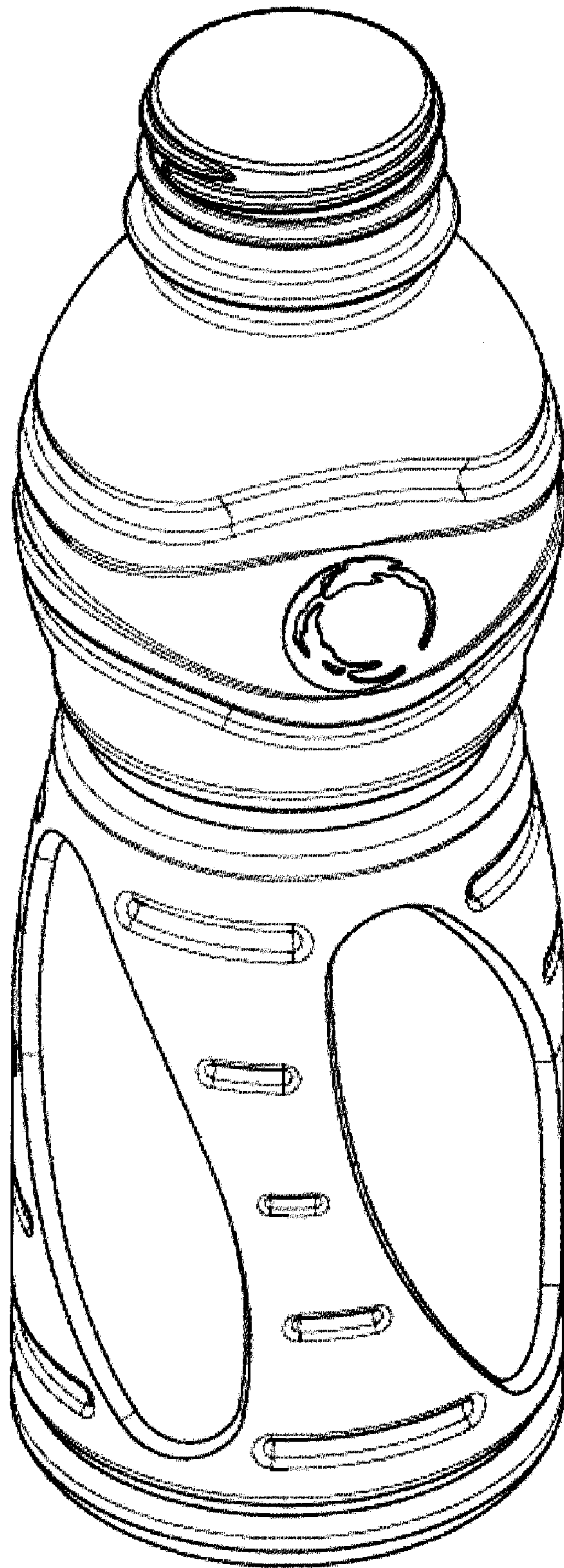

Fig. 1

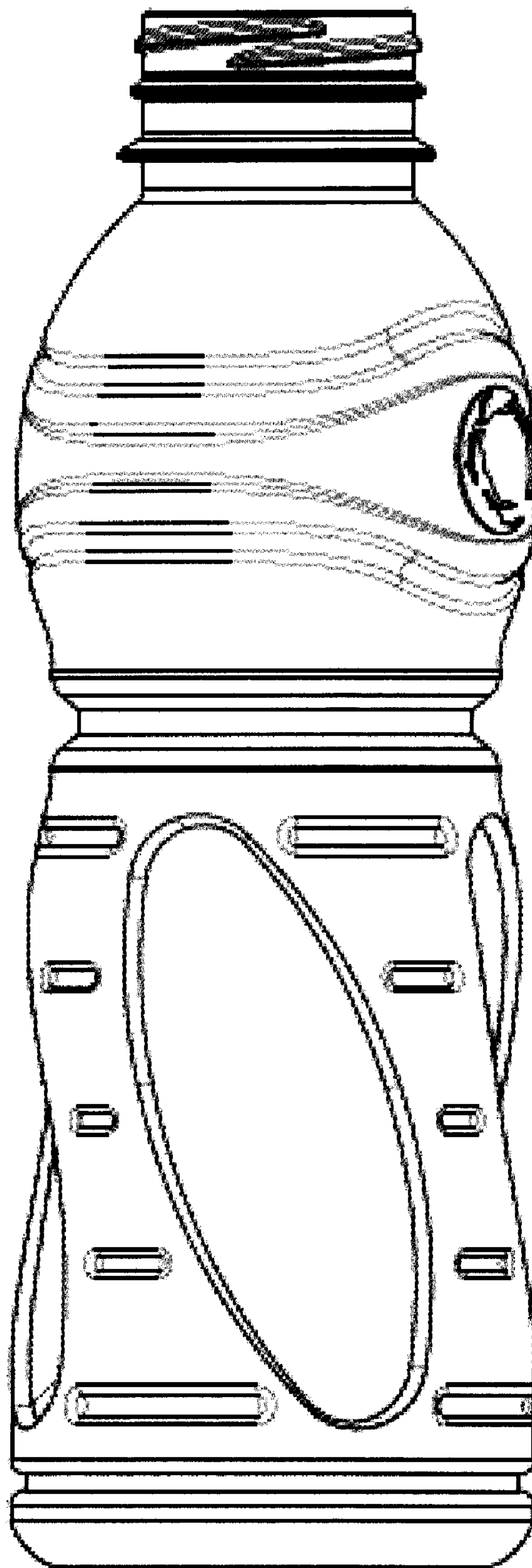

Fig. 2

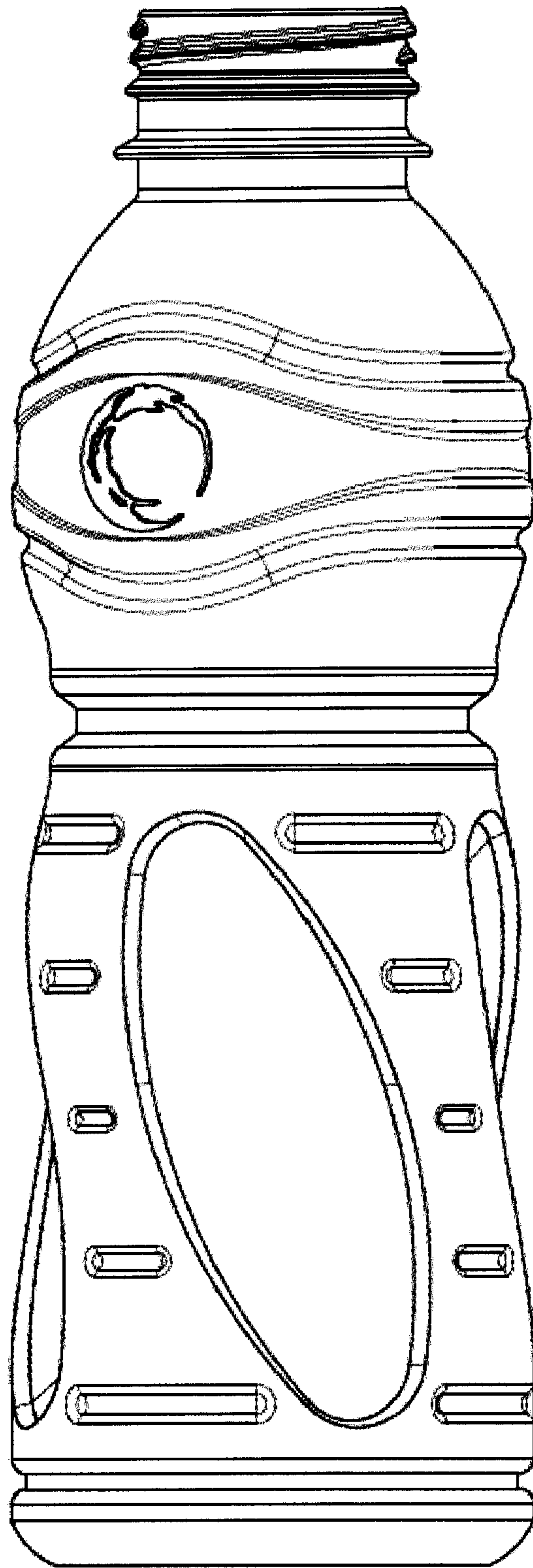

Fig. 3

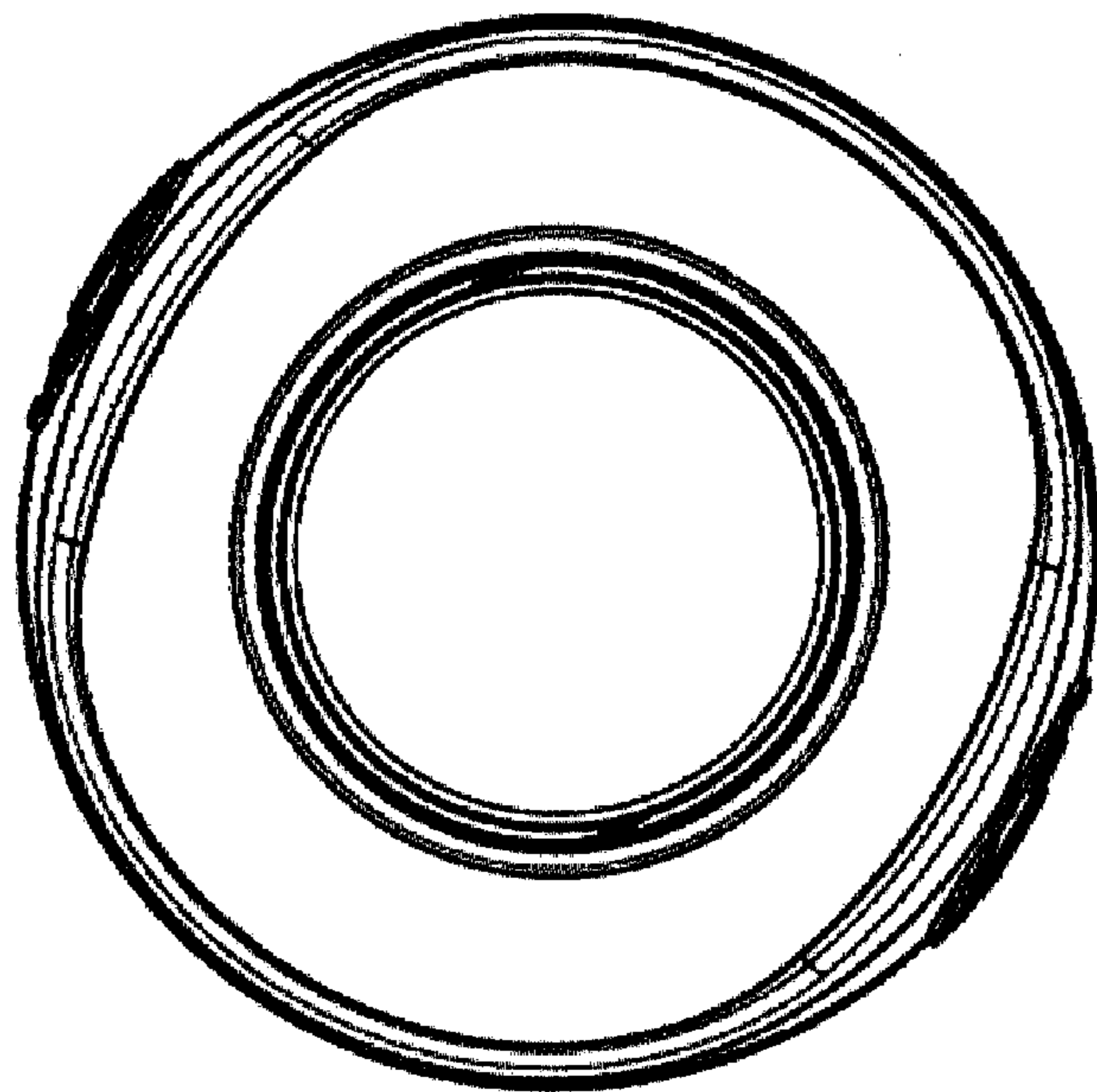

Fig. 4

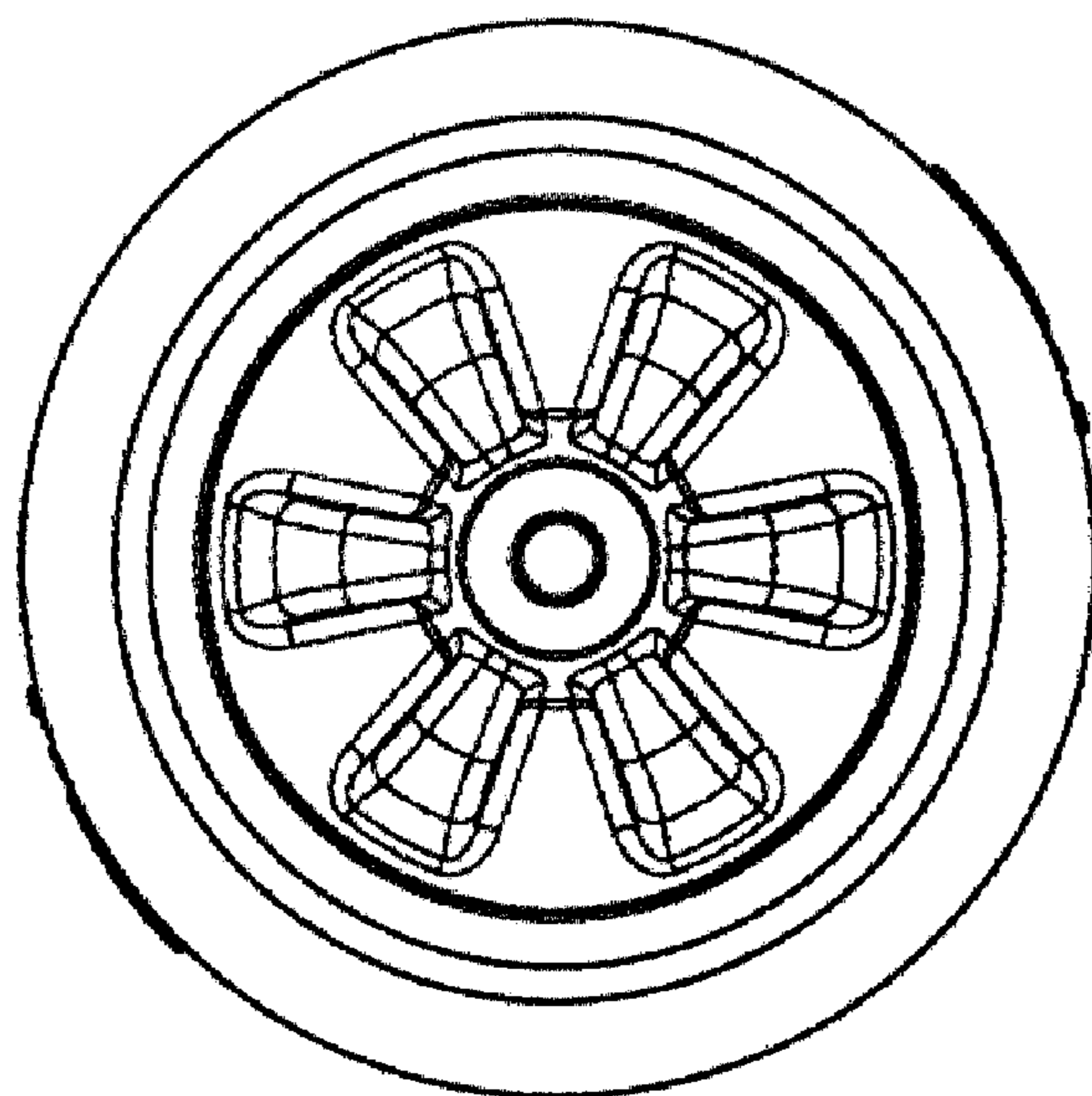

Fig. 5

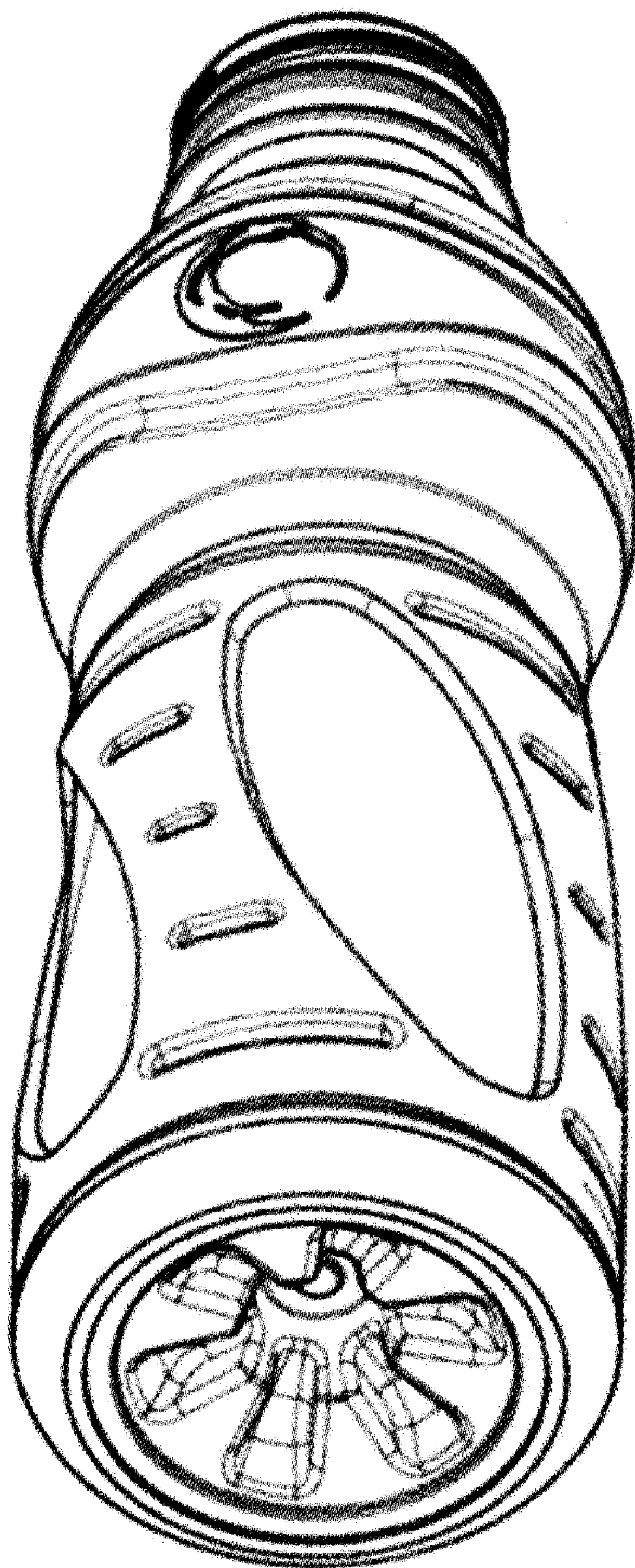

Fig. 6