



US00D620318S

(12) **United States Design Patent**
Bizzell et al.

(10) **Patent No.:** **US D620,318 S**
(45) **Date of Patent:** **** *Jul. 27, 2010**

(54) **FOOD CONTAINER ASSEMBLY**

(75) Inventors: **Daniel Lee Bizzell**, Davidson, NC (US);
Ian Kovacevich, Charlotte, NC (US);
David Berglund, Marvin, NC (US);
Carole Ruffin, Charlotte, NC (US)

(73) Assignee: **Edison Nation, LLC**, Charlotte, NC (US)

(*) Notice: This patent is subject to a terminal disclaimer.

(**) Term: **14 Years**

(21) Appl. No.: **29/304,331**

(22) Filed: **Feb. 28, 2008**

Related U.S. Application Data

(63) Continuation-in-part of application No. 12/028,824, filed on Feb. 10, 2008, and a continuation-in-part of application No. 12/028,825, filed on Feb. 10, 2008, and a continuation-in-part of application No. 12/028,826, filed on Feb. 10, 2008, and a continuation-in-part of application No. 12/028,827, filed on Feb. 10, 2008, and a continuation-in-part of application No. 12/028,828, filed on Feb. 10, 2008, and a continuation-in-part of application No. 12/028,829, filed on Feb. 10, 2008.

(51) **LOC (9) Cl.** **07-01**

(52) **U.S. Cl.** **D7/541; D7/553.4**

(58) **Field of Classification Search** D7/500,
D7/505, 540, 555, 560, 554.2, 566, 584, 585,
D7/587, 570, 567, 543, 553.2, 553.4, 769,
D7/541, 553.8, 552.2, 629, 586; 229/401,
229/406; 220/574, 575, 561, 574.1

See application file for complete search history.

(56) **References Cited**

U.S. PATENT DOCUMENTS

948,434 A 2/1910 Scoot
D67,011 S 4/1925 Clarke
1,595,356 A 8/1926 Moseman

1,858,728 A 5/1932 Creighton
2,050,206 A * 8/1936 Chaplin 220/574
2,322,665 A 6/1943 Ryan
D154,224 S 6/1949 Tweet
D160,688 S 10/1950 Brock
2,781,651 A 2/1957 Cutler
D185,911 S 8/1959 Chadbourne et al.

(Continued)

OTHER PUBLICATIONS

Information Disclosure Statement (IDS) Letter, including Exhibit A (five pages of photographs), submitted by Applicant on Apr. 10, 2009.

Primary Examiner—Charles A Rademaker

(74) *Attorney, Agent, or Firm*—Chad D. Tillman; James D. Wright; Tillman & Wright, PLLC

(57) **CLAIM**

The ornamental design for a food container assembly, as shown and described.

DESCRIPTION

FIG. 1 is a top and front perspective view of a food container assembly showing our new design.

FIG. 2 is top plan view thereof.

FIG. 3 is a bottom plan view thereof.

FIG. 4 is a first side elevation view thereof.

FIG. 5 is a second side elevation view thereof; and,

FIG. 6 is representative of the third and fourth side elevation views thereof.

The portions of the food container assembly not shown form no part of the claimed design.

1 Claim, 4 Drawing Sheets

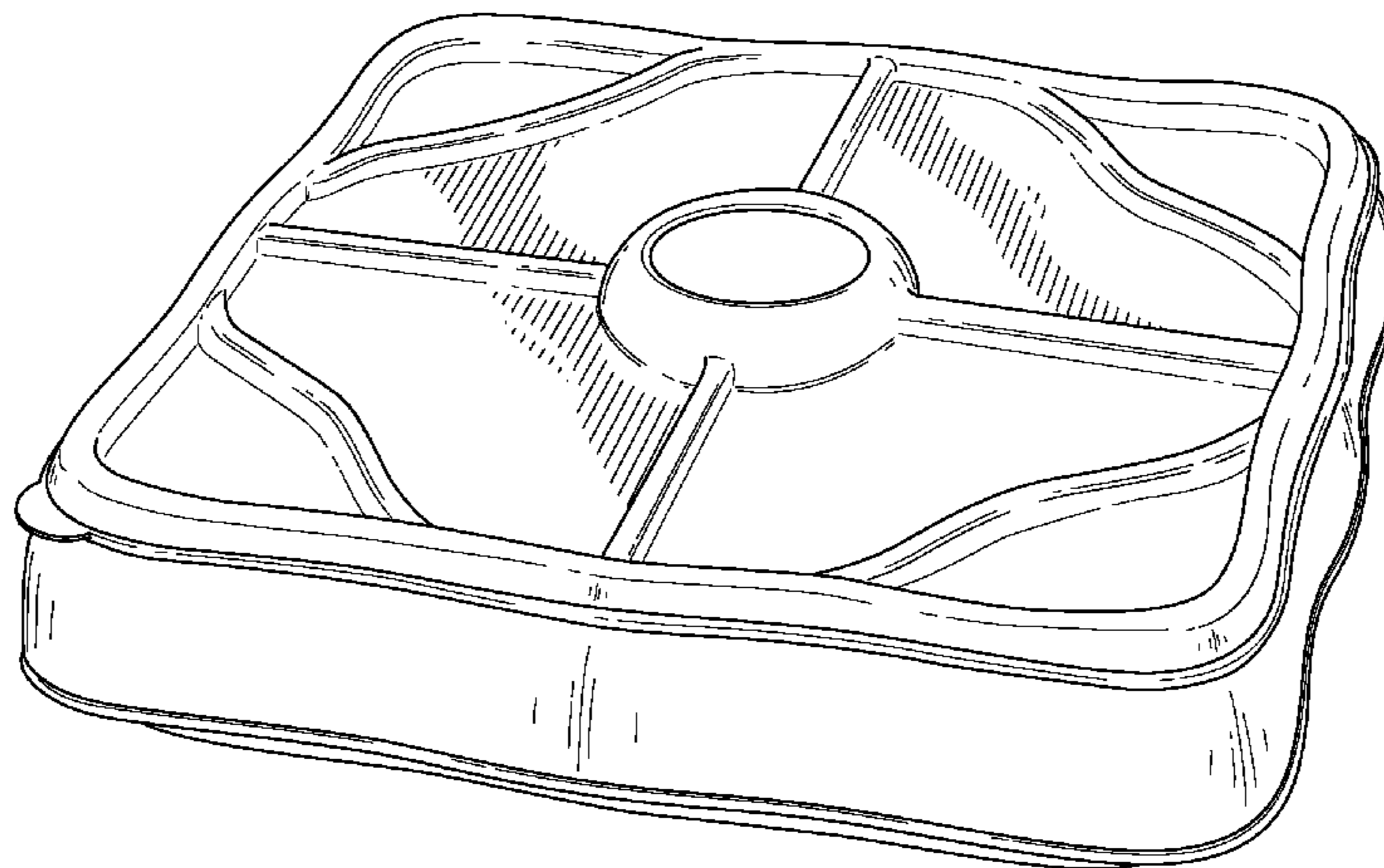

US D620,318 S

Page 2

U.S. PATENT DOCUMENTS						
			D460,897 S *	7/2002	Leuenberger D7/553.8
			D461,099 S	8/2002	Leuenberger	
2,897,974 A	8/1959	Cook	6,514,548 B2	2/2003	Lin	
2,951,610 A *	9/1960	Smalley, Jr. 220/575	6,550,630 B1	4/2003	Krupa	
3,099,377 A *	7/1963	Metzler et al. 229/406	D489,972 S	5/2004	Lin	
D206,762 S	1/1967	Kirwan	6,783,017 B2	8/2004	Griffin	
D221,883 S	9/1971	Cash	D496,831 S	10/2004	Strahota et al.	
D230,001 S	1/1974	Wright	D511,273 S	11/2005	Hadeler	
3,811,594 A	5/1974	Paulucci	D516,867 S *	3/2006	Martin et al. D7/586	
D232,294 S	8/1974	Christian et al.	D527,954 S	9/2006	Roth	
4,351,164 A	9/1982	Christiani	D572,540 S *	7/2008	Shew et al. D7/629	
D285,638 S	9/1986	Trivison	D572,541 S *	7/2008	Shew et al. D7/629	
D291,042 S	7/1987	Fahey et al.	D586,623 S *	2/2009	Dunn D7/541	
4,732,274 A	3/1988	Bouton	D587,529 S *	3/2009	Pratt D7/555	
4,865,219 A	9/1989	Logan et al.	D592,013 S *	5/2009	Bizzell et al. D7/553.4	
D304,658 S	11/1989	Mattei	D592,014 S *	5/2009	Bizzell et al. D7/553.4	
D312,026 S	11/1990	Antoni	2007/0062965 A1	3/2007	Anderson et al.	
D352,204 S	11/1994	Hayes et al.	2008/0029426 A1	2/2008	Anderson et al.	
D366,395 S *	1/1996	Wyatt et al. D7/552.2	2008/0029427 A1	2/2008	Anderson et al.	
5,593,062 A	1/1997	Martin	2008/0083759 A1	4/2008	Anderson et al.	
D399,095 S	10/1998	Schmidt	2008/0083760 A1	4/2008	Anderson et al.	
D401,810 S	12/1998	Swift	2008/0110914 A1	5/2008	Anderson et al.	
5,894,944 A	4/1999	Swift	2008/0121550 A1	5/2008	Anderson et al.	
6,042,856 A	3/2000	Sagan et al.	2008/0121551 A1	5/2008	Anderson et al.	
D426,110 S	6/2000	Schmidt	2008/0121552 A1	5/2008	Anderson et al.	
6,168,813 B1	1/2001	Blazevich	2008/0124440 A1	5/2008	Anderson et al.	
D449,966 S	11/2001	DeMars	2008/0128313 A1	6/2008	Anderson et al.	
6,401,927 B1	6/2002	Sorensen et al.				

* cited by examiner

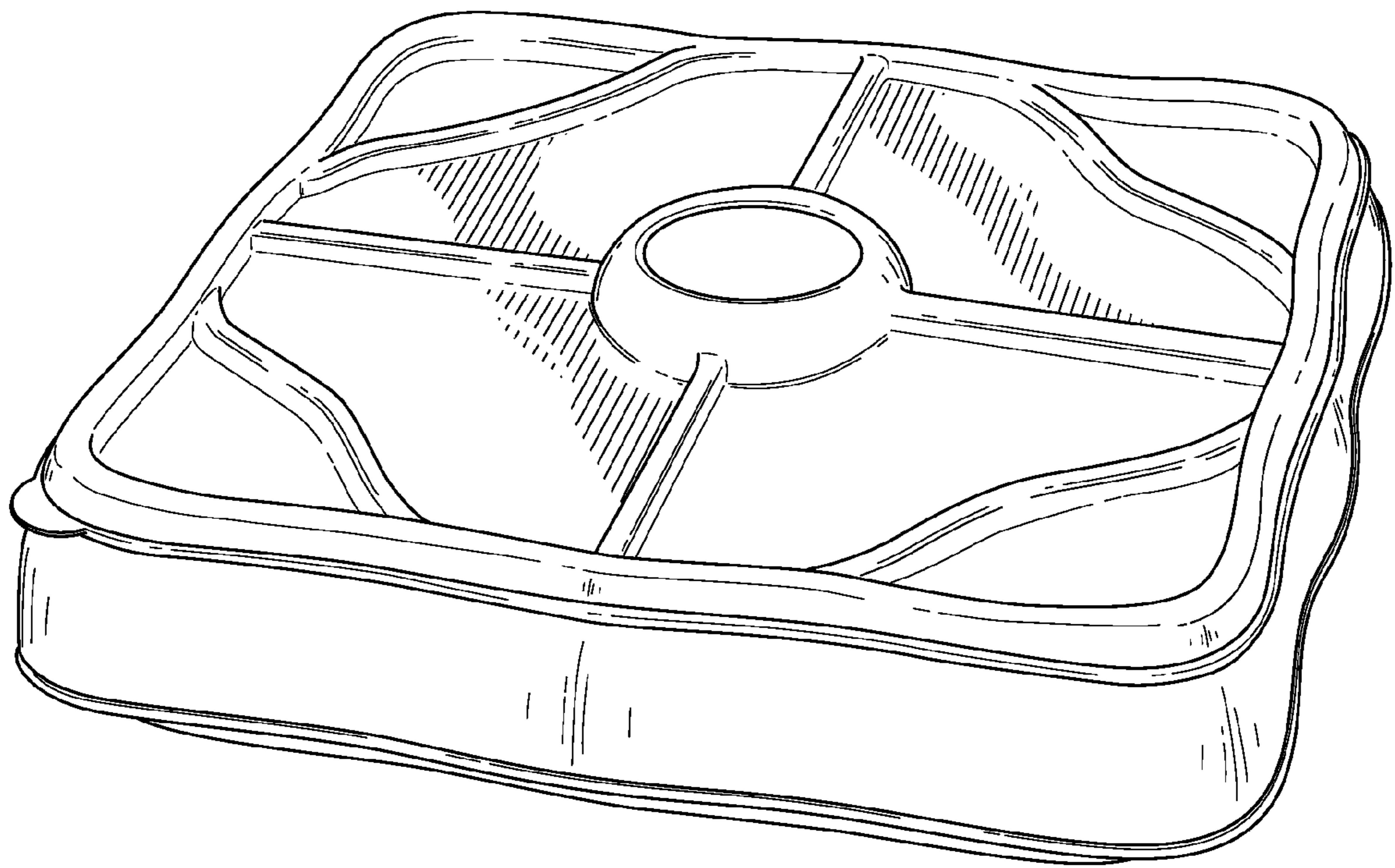

FIG. 1

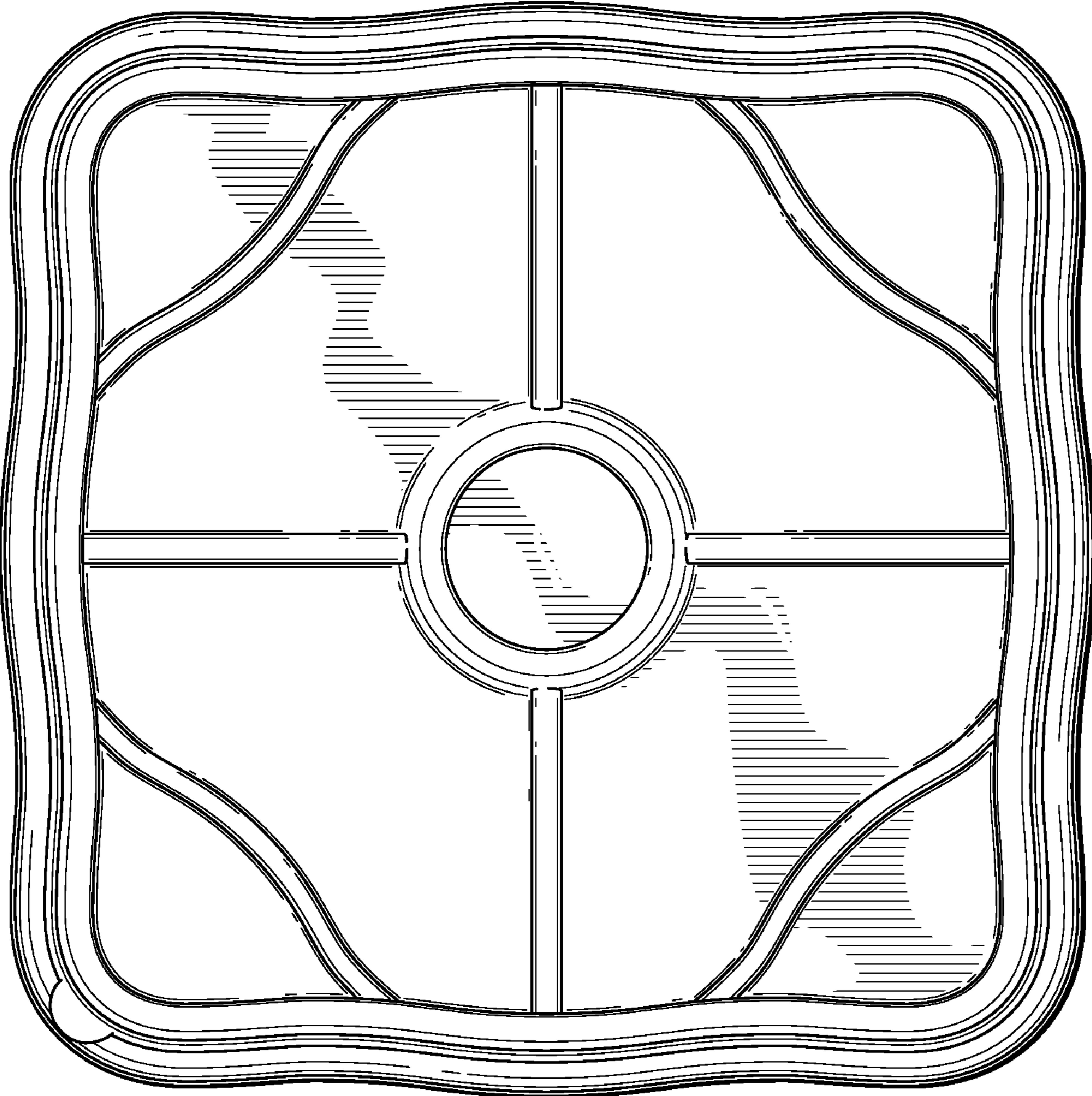

FIG. 2

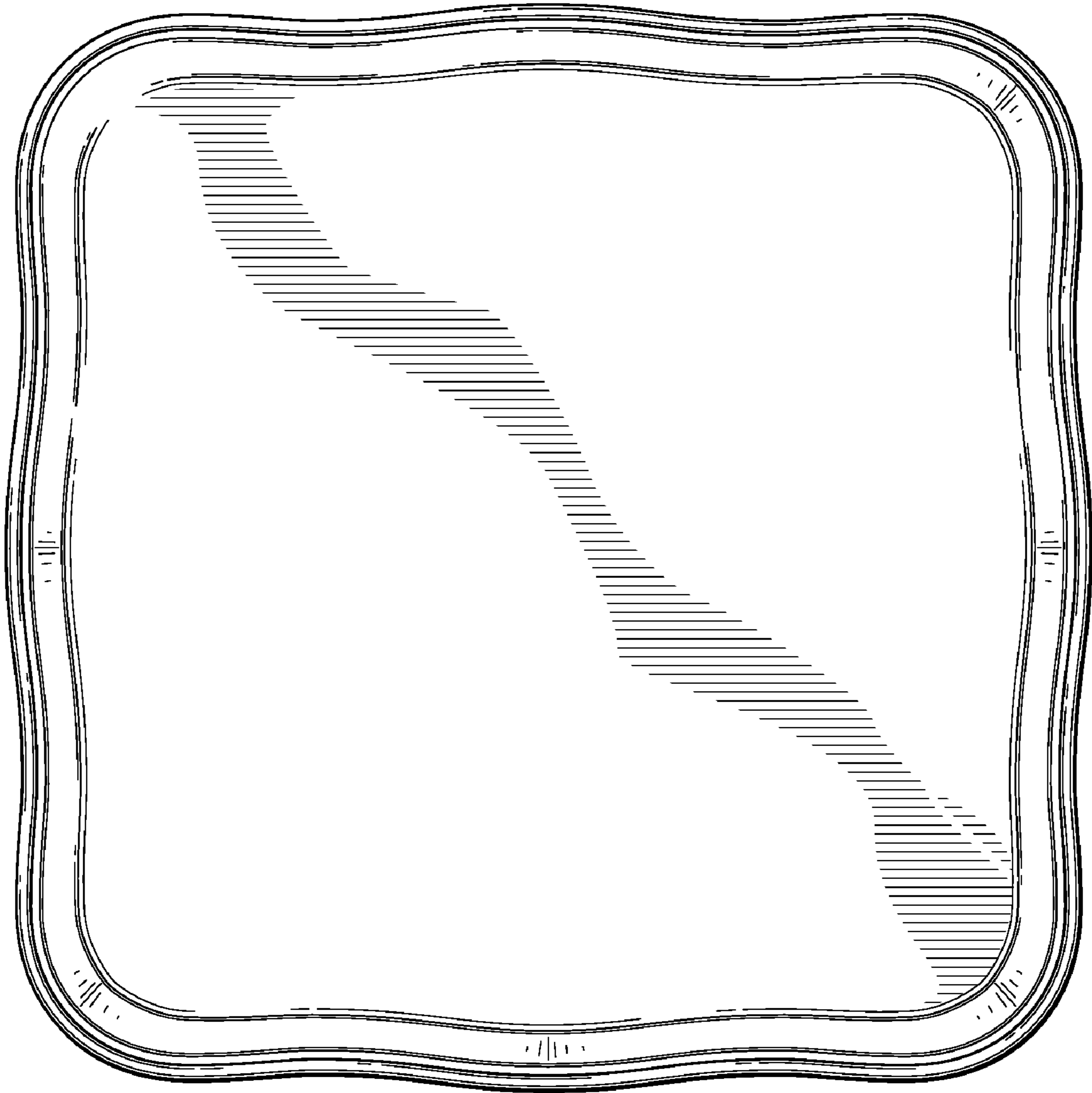

FIG. 3

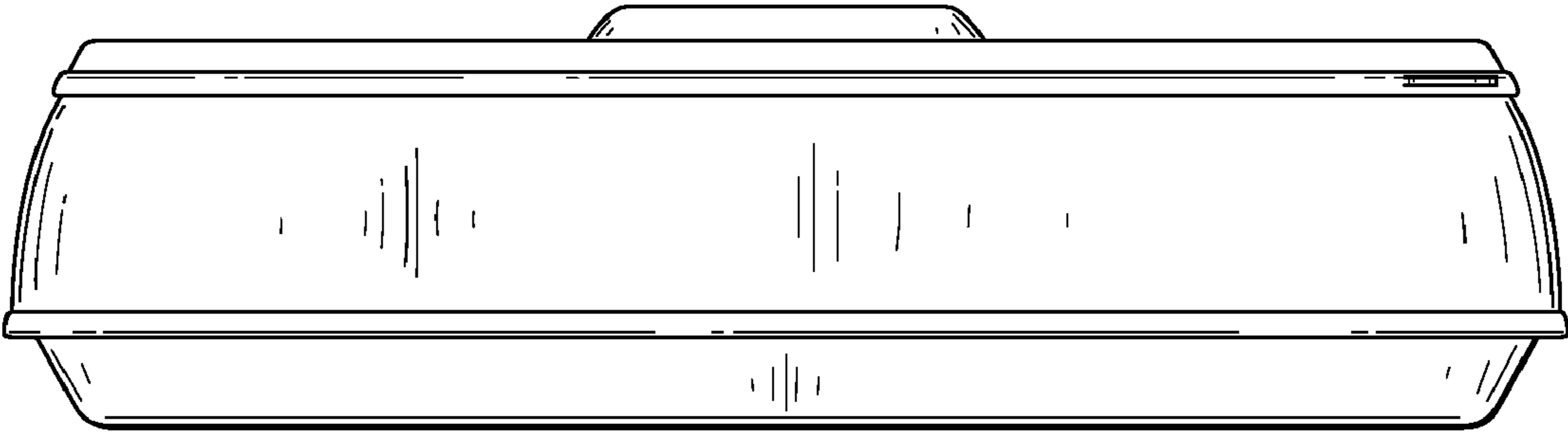

FIG. 4

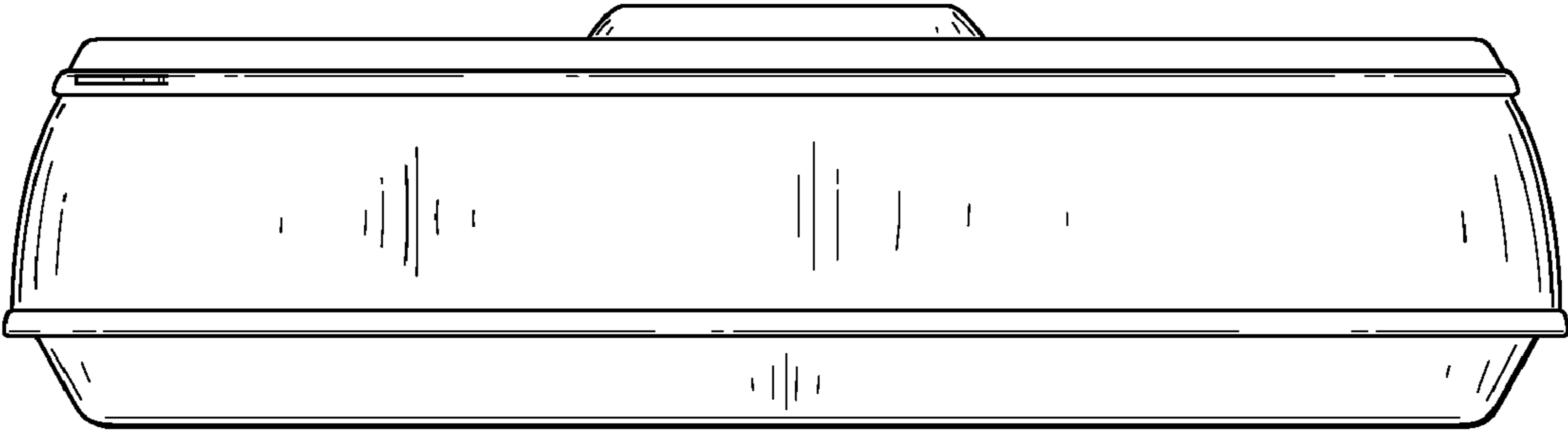

FIG. 5

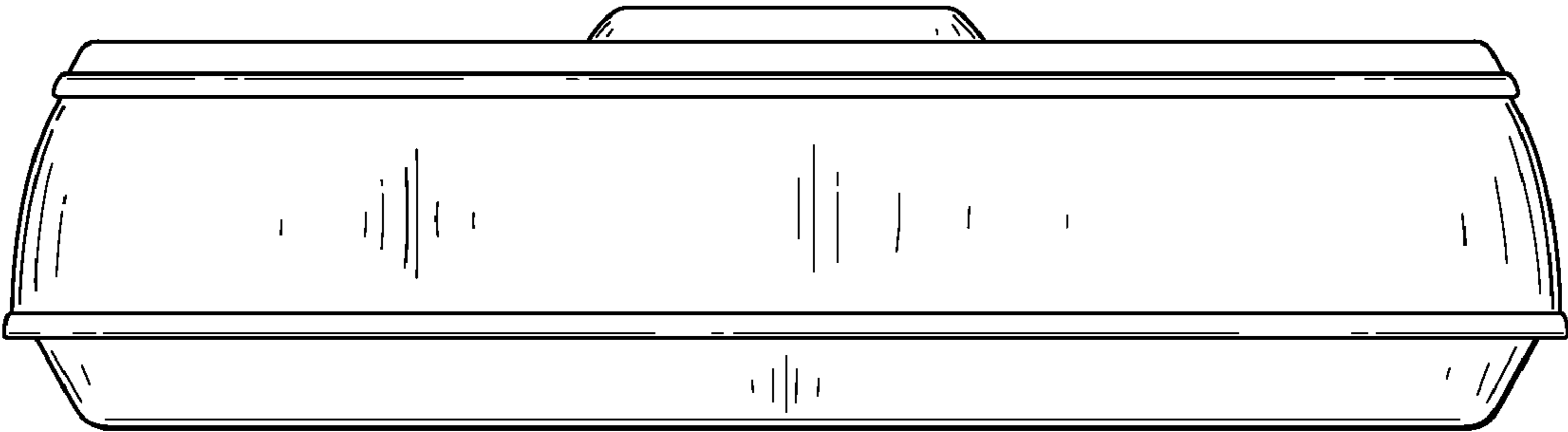

FIG. 6