



US00D620252S

(12) **United States Design Patent**
Keels

(10) **Patent No.:** **US D620,252 S**
(45) **Date of Patent:** **** Jul. 27, 2010**

(54) **WALLET**

(76) **Inventor:** **Ben Keels**, 2904 SE. 30th Ave.,
Gresham, OR (US) 97080

(**) **Term:** **14 Years**

(21) **Appl. No.:** **29/351,212**

(22) **Filed:** **Dec. 2, 2009**

(51) **LOC (9) Cl.** **03-01**

(52) **U.S. Cl.** **D3/247**

(58) **Field of Classification Search** D3/247-252;
150/100, 103-110, 113-114, 118-119; 294/149-150,
294/165

See application file for complete search history.

(56) **References Cited**

U.S. PATENT DOCUMENTS

3,108,627	A *	10/1963	Tatelman	150/103
6,447,037	B1 *	9/2002	Crouch	294/149
D471,006	S *	3/2003	French	D3/221
D509,065	S *	9/2005	Koenig	D3/327

* cited by examiner

Primary Examiner—Holly H Baynham

(74) *Attorney, Agent, or Firm*—Peter A. Haas, Esquire LLC

(57) **CLAIM**

The ornamental design for a wallet, as shown and described.

DESCRIPTION

FIG. 1 is a top view of the invention;

FIG. 2 is a top environmental view of the invention as it may be used to hold bills and/or credit cards;

FIG. 3 is a bottom view of the invention;

FIG. 4 is a bottom alternate environmental view of the invention as it may be used to hold bills and/or credit cards;

FIG. 5 is a left side view of the invention;

FIG. 6 is a front view of the invention;

FIG. 7 is an off-set top view of the invention;

FIG. 8 is an off-set top alternate environmental view of the invention as it may be used to hold bills and/or credit cards; and,

FIG. 9 is an off-set bottom alternate environmental view of the invention as it may be used to hold bills and/or credit cards.

The broken line showing of currency and credit cards is included for the purpose of illustrating environment and forms no part of the claimed design.

The broken lines showing stitching are part of the claimed design.

Those skilled in the art will appreciate from the drawing that the characteristic features may be sewn, folded, or otherwise formed during creating and further that the wallet is symmetrical with respect to the left and right sides and front and back relative to the top view.

1 Claim, 5 Drawing Sheets

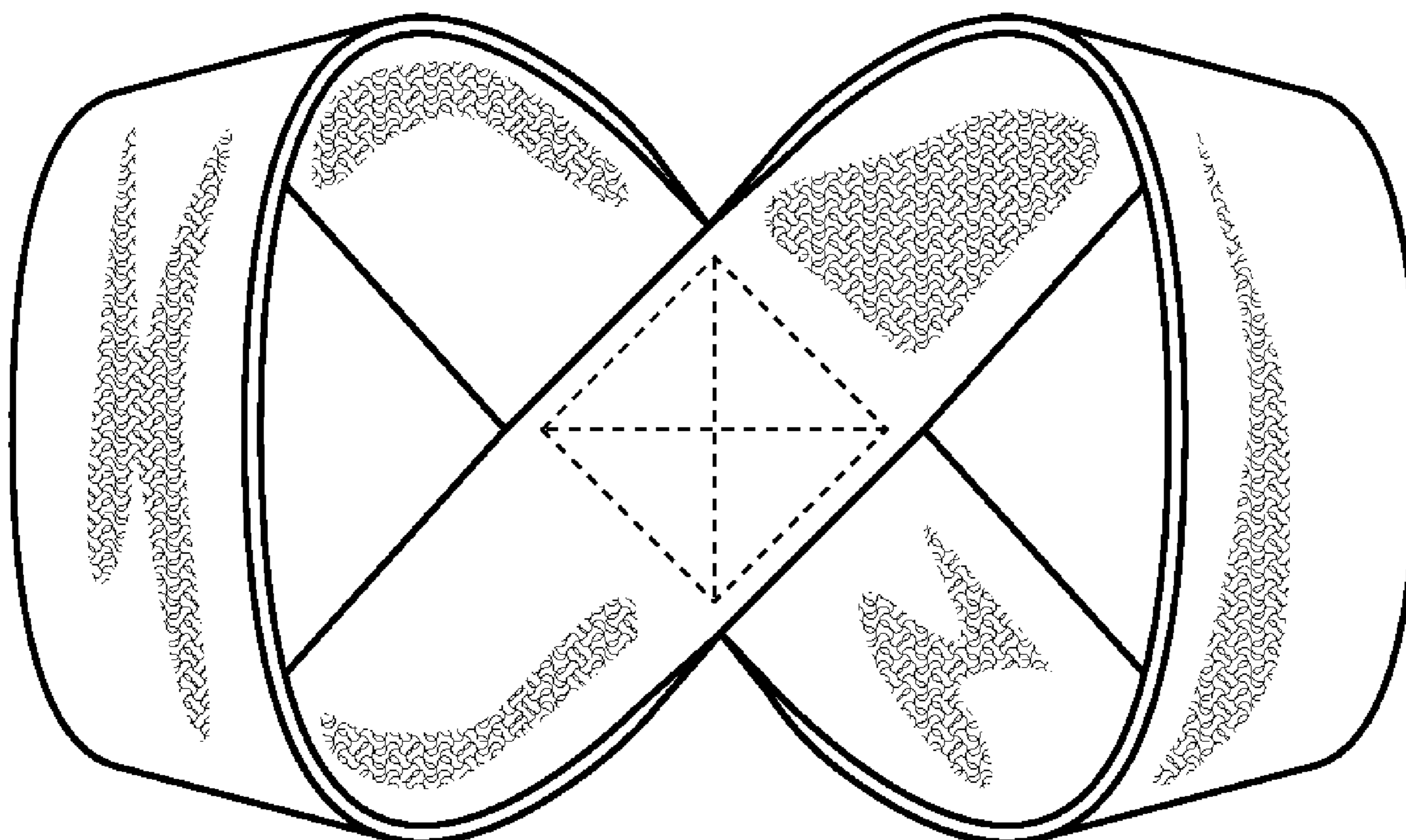

FIG. 1

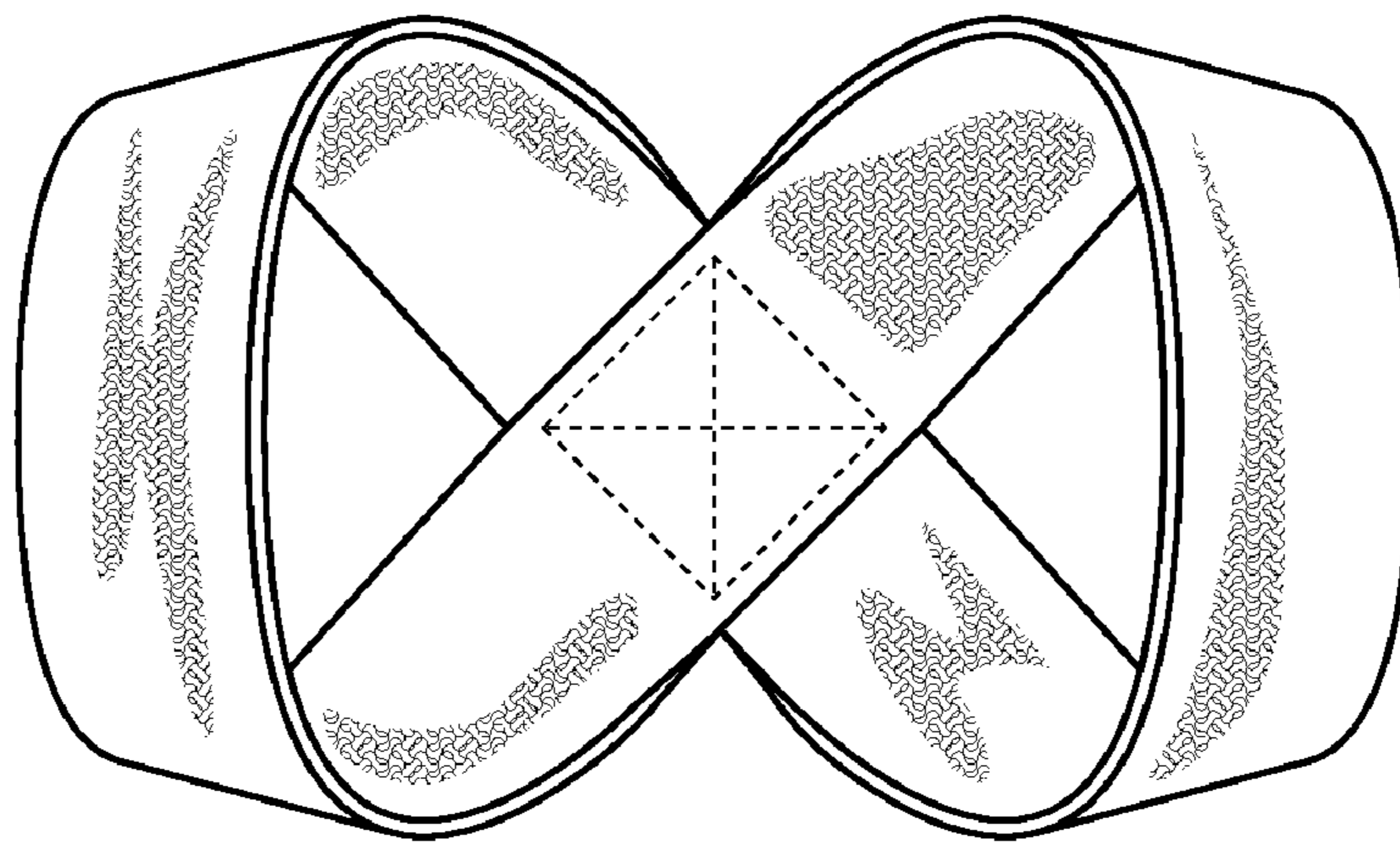

FIG. 2

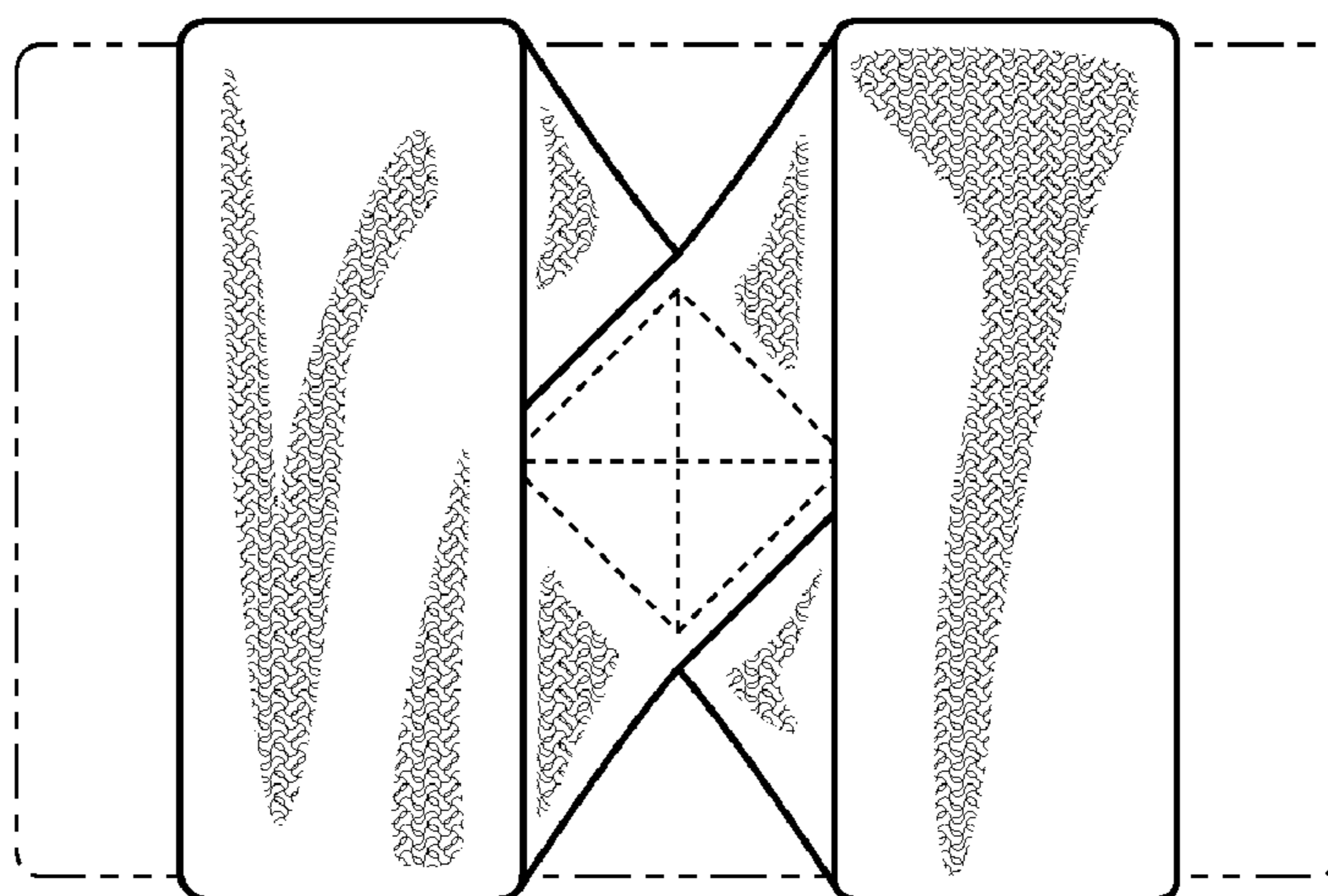

FIG. 3

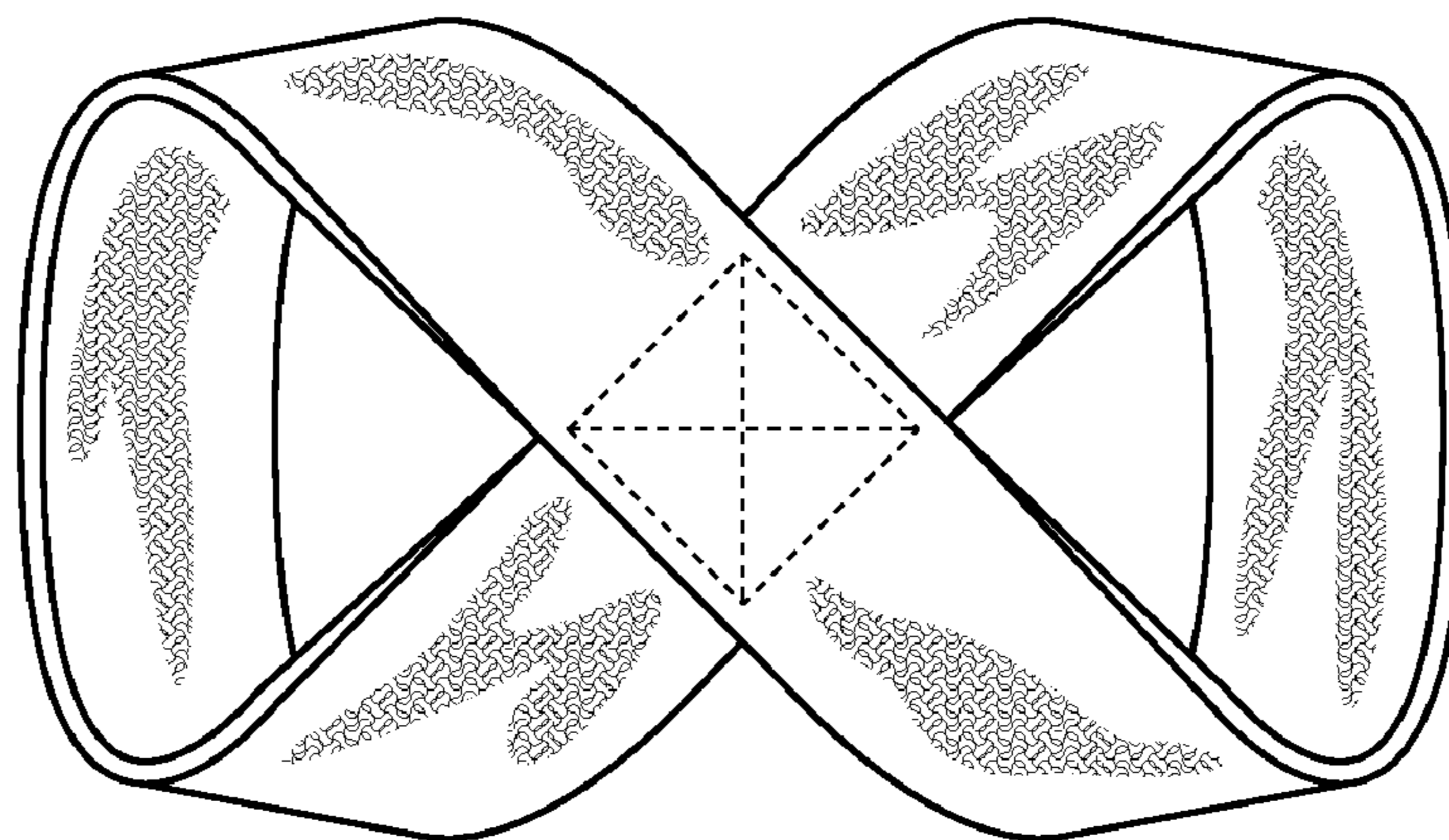

FIG. 4

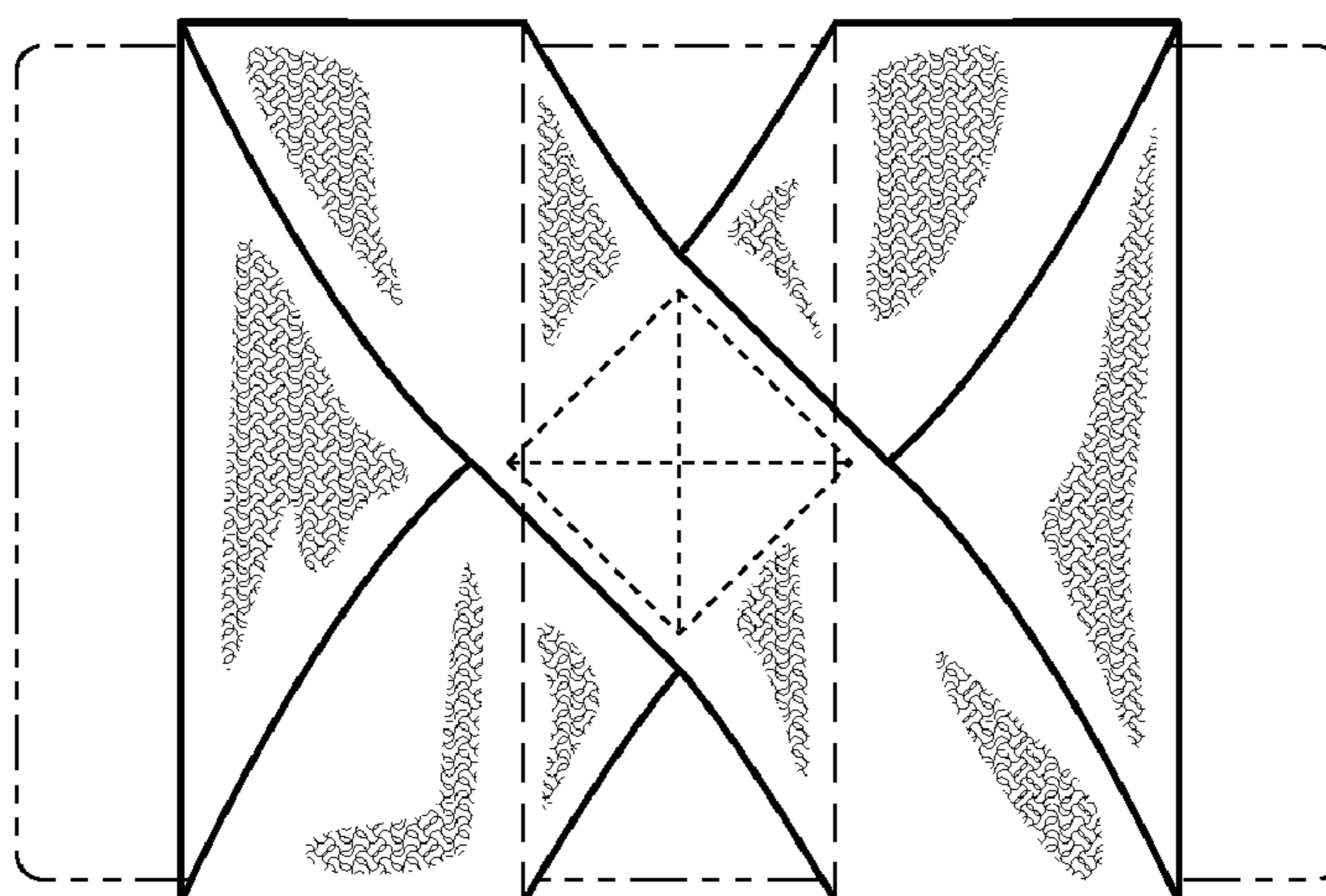

FIG. 5

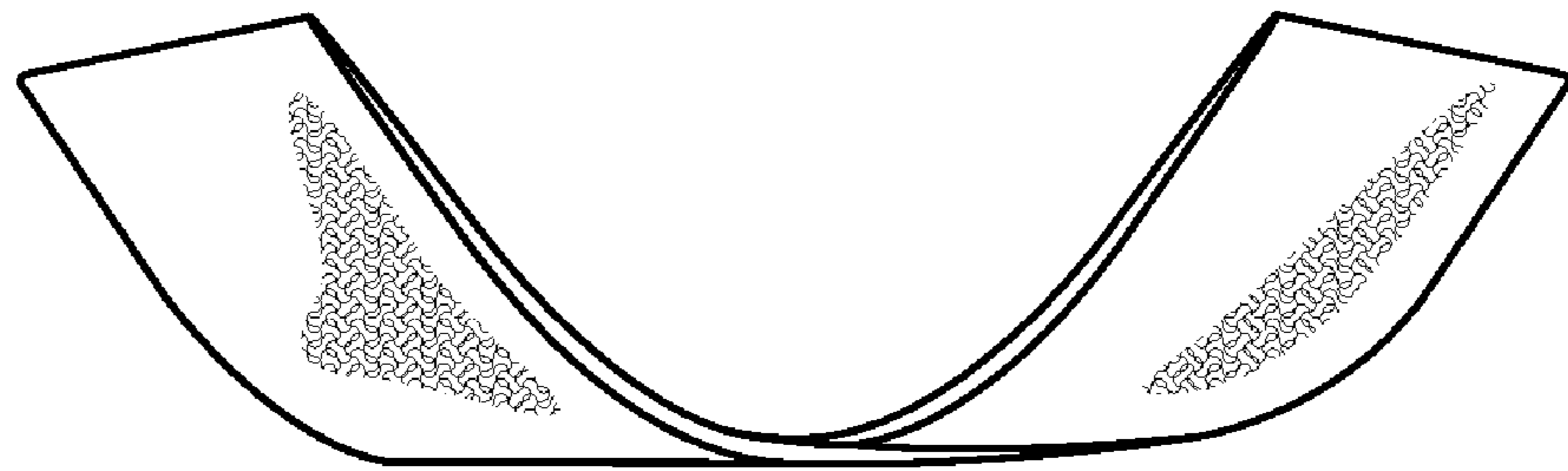

FIG. 6

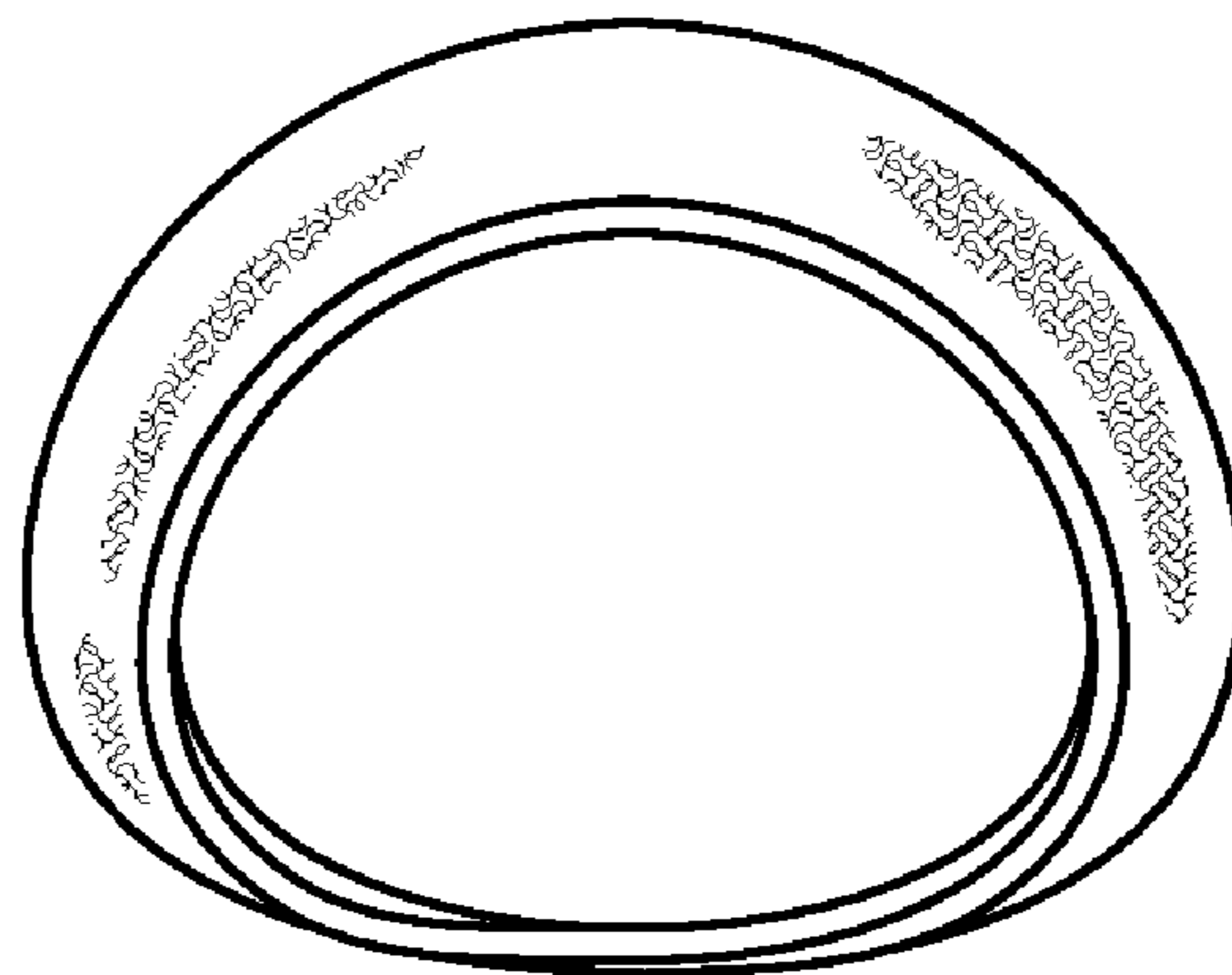

FIG. 7

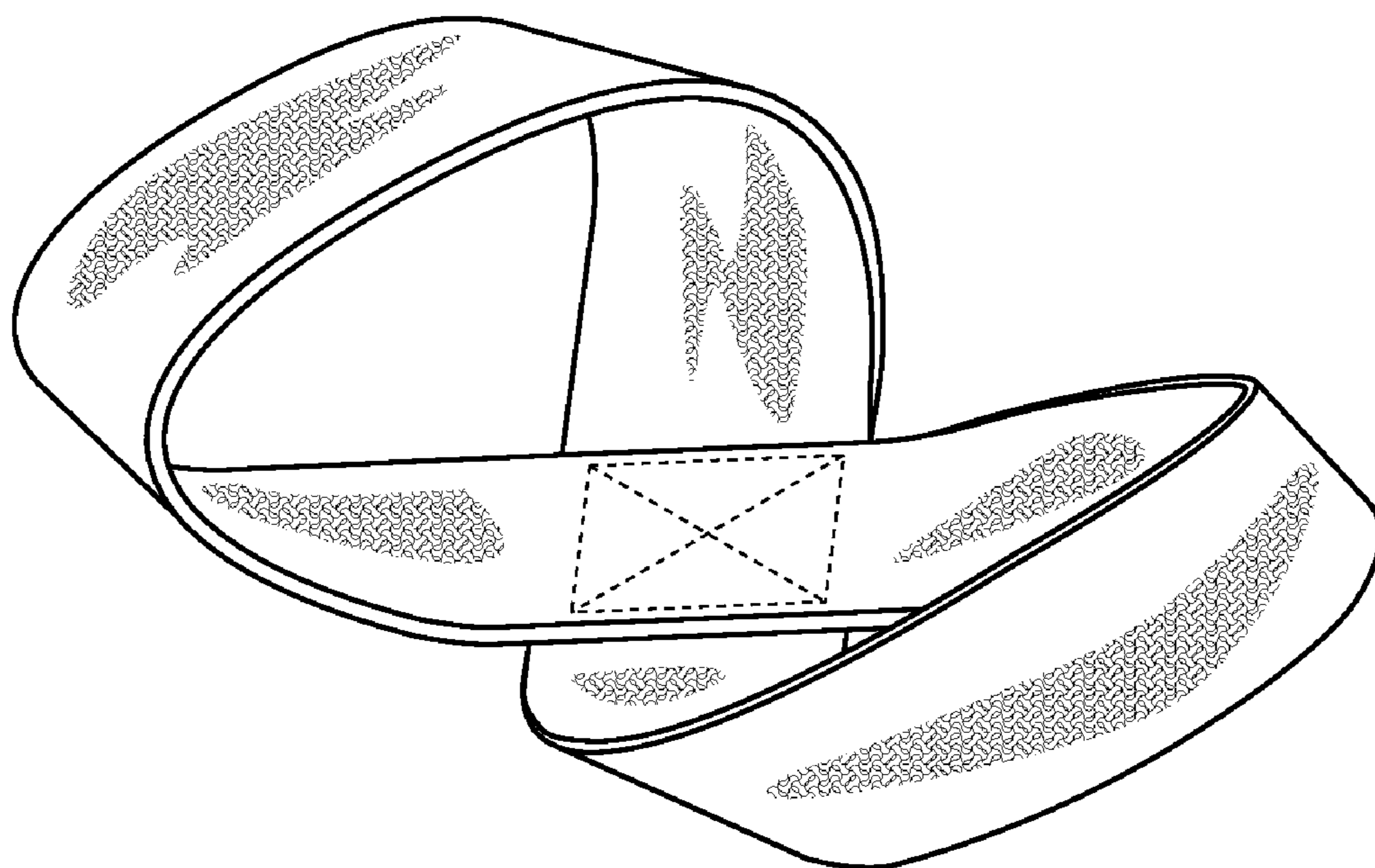

FIG. 8

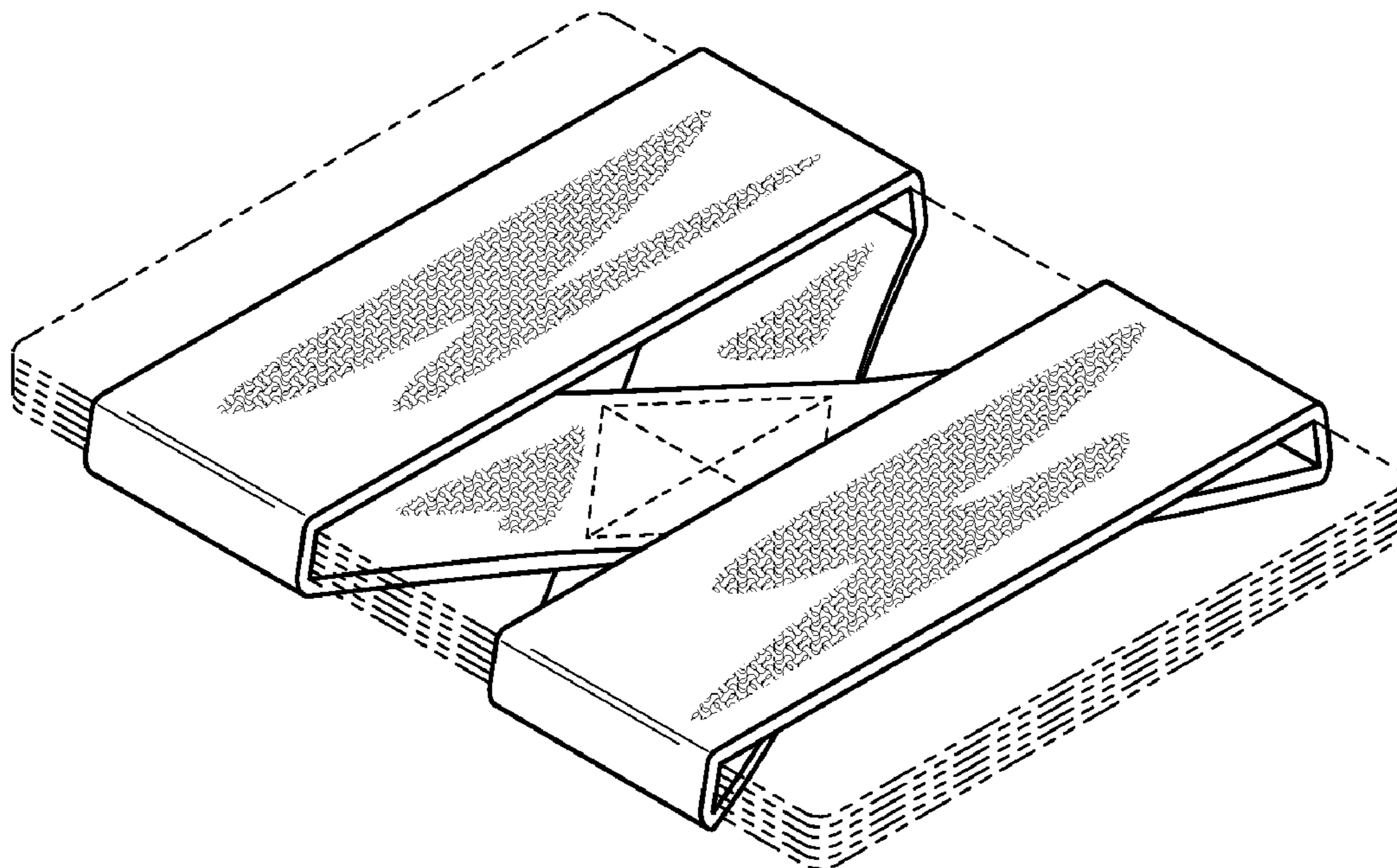

FIG. 9

