



US00D620145S

(12) **United States Design Patent**
Henriquez

(10) **Patent No.:** **US D620,145 S**
(45) **Date of Patent:** **** Jul. 20, 2010**

(54) **DUAL FUNCTION INSULATED FLOOR AND ROOF PANEL WITH ANGLED ENDS FOR INTEGRATED CONCRETE FLOOR AND ROOF**

(76) Inventor: **Jose L. Henriquez**, 4443 SW. 16th St., Miami, FL (US) 33134

(**) Term: **14 Years**

(21) Appl. No.: **29/342,374**

(22) Filed: **Aug. 24, 2009**

Related U.S. Application Data

(63) Continuation-in-part of application No. 29/310,740, filed on Sep. 8, 2008, now Pat. No. Des. 604,867.

(51) **LOC (9) Cl.** **25-02**

(52) **U.S. Cl.** **D25/138**

(58) **Field of Classification Search** D25/138-139, D25/149-150, 157, 113, 58, 119; 52/578, 52/588.1, 586.1, 586.2, 782.1, 783.1, 589.1, 52/311.1, 311.2, 414-415, 474-475.1, 483.1
See application file for complete search history.

(56) **References Cited**

U.S. PATENT DOCUMENTS

4,372,522	A *	2/1983	Simeonoff	52/578
D331,117	S *	11/1992	Genco	D25/138
5,673,524	A *	10/1997	Gailey	52/588.1
D419,246	S *	1/2000	Lane et al.	D25/138
D440,327	S *	4/2001	Keating et al.	D25/138
D482,804	S *	11/2003	Schwagermann	D25/138

* cited by examiner

Primary Examiner—Catherine R Oliver

(74) *Attorney, Agent, or Firm*—Melvin K. Silverman; Yi Li

(57) **CLAIM**

The ornamental design for a dual function insulated floor and roof panel with angled ends for integrated concrete floor and roof, as shown and described.

DESCRIPTION

FIG. 1 is a top, front and right side perspective view of a dual function insulated floor and roof panel with angled ends for integrated concrete floor and roof, showing my new design; FIG. 2 is a bottom, rear and right side perspective view of the panel shown in FIG. 1;

FIG. 3 is a right side elevational view of the panel shown in FIG. 1;

FIG. 4 is a left side elevational view of the panel shown in FIG. 1;

FIG. 5 is a front elevational view of the panel shown in FIG. 1, the opposite side being a mirror image;

FIG. 6 is a top plan view of the panel shown in FIG. 1; and

FIG. 7 is a bottom plan view of the panel shown in FIG. 1;

FIG. 8 is a top, front and right side perspective view of a further embodiment of the dual function insulated floor and roof panel with angled ends shown in FIG. 1, including two wrapping bands wrapped around the panel, showing my new design;

FIG. 9 is a bottom, rear and right side perspective view of the panel shown in FIG. 8;

FIG. 10 is a right side elevational view of the panel shown in FIG. 8;

FIG. 11 is a left side elevational view of the panel shown in FIG. 8;

FIG. 12 is a front elevational view of the panel shown in FIG. 8, the opposite side being a mirror image;

FIG. 13 is a top plan view of the panel shown in FIG. 8; and

FIG. 14 is a bottom plan view of the panel shown in FIG. 8;

FIG. 15 is a top, front and right side perspective view of yet a further embodiment of the dual function insulated floor and roof panel with angled ends shown in FIG. 1, including a

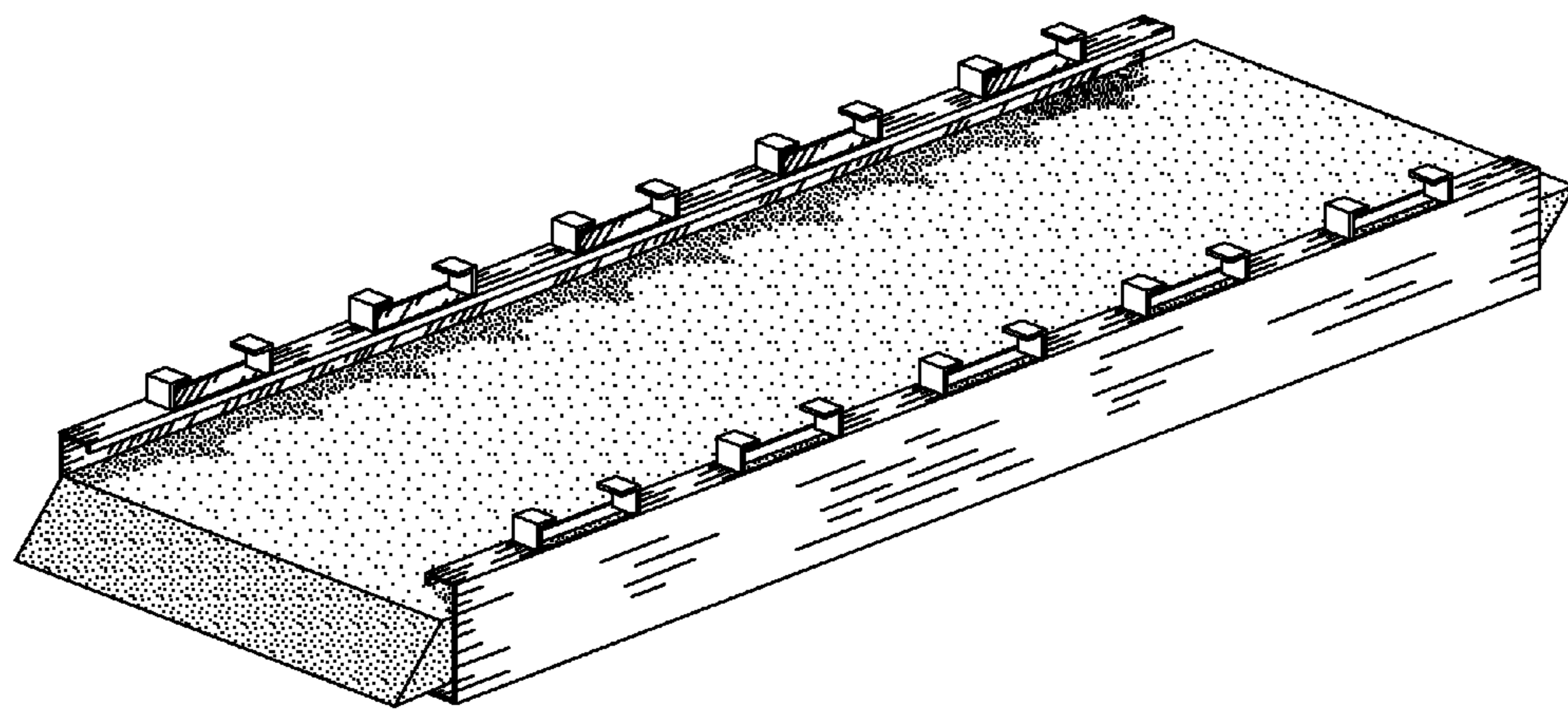

plurality of through-holes on web sections of studs of the panel, showing my new design;

FIG. 16 is a bottom, rear and right side perspective view of the panel shown in FIG. 15;

FIG. 17 is a right side elevational view of the panel shown in FIG. 15;

FIG. 18 is a left side elevational view of the panel shown in FIG. 15;

FIG. 19 is a front elevational view of the panel shown in FIG. 15, the opposite side being a mirror image;

FIG. 20 is a top plan view of the panel shown in FIG. 15; and

FIG. 21 is a bottom plan view of the panel shown in FIG. 15;

FIG. 22 is a top, front and right side perspective view of a further embodiment of the dual function insulated floor and

roof panel with angled ends shown in FIG. 15, including two wrapping bands wrapped around the panel, showing my new design;

FIG. 23 is a bottom, rear and right side perspective view of the panel shown in FIG. 22;

FIG. 24 is a right side elevational view of the panel shown in FIG. 22;

FIG. 25 is a left side elevational view of the panel shown in FIG. 22;

FIG. 26 is a front elevational view of the panel shown in FIG. 22, the opposite side being a mirror image;

FIG. 27 is a top plan view of the panel shown in FIG. 22; and,

FIG. 28 is a bottom plan view of the panel shown in FIG. 22.

1 Claim, 12 Drawing Sheets

Fig. 1

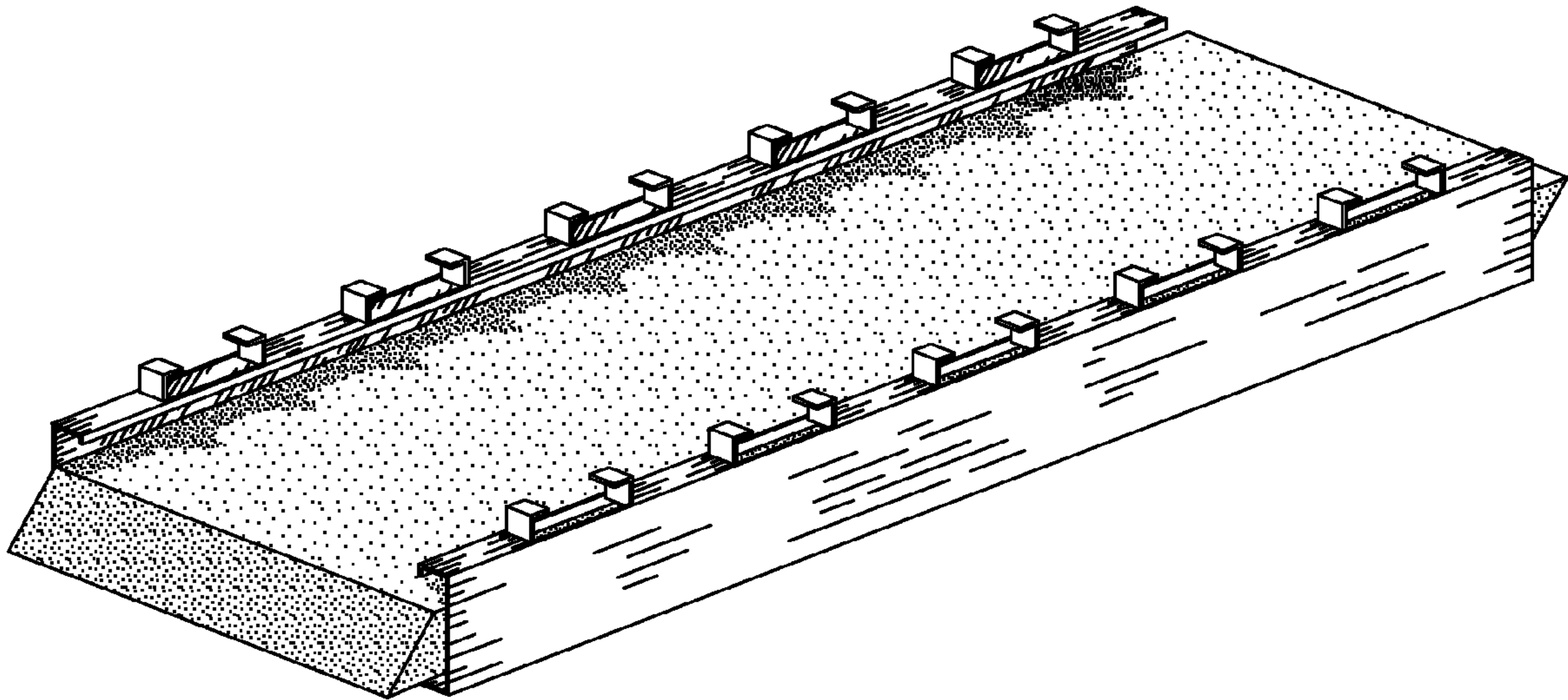

Fig. 2

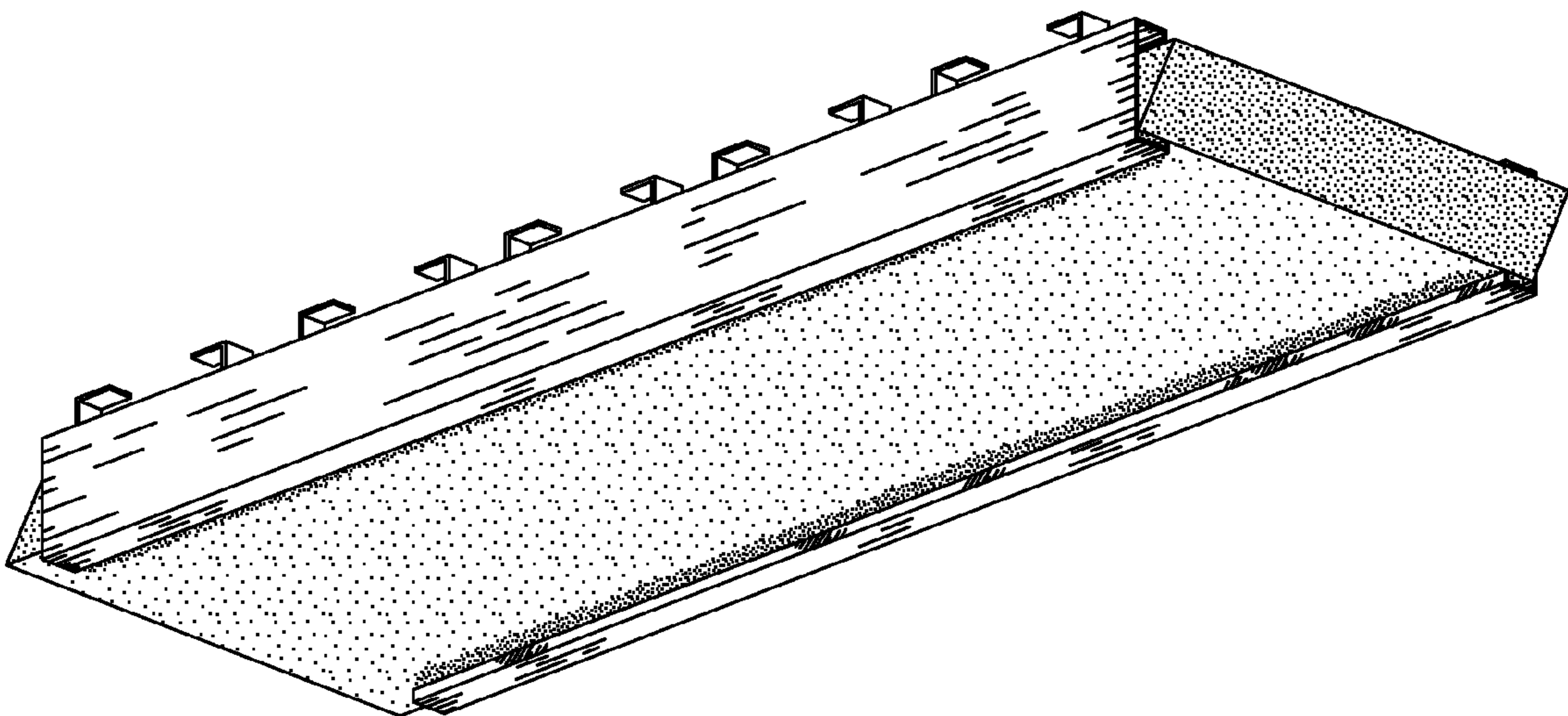

Fig. 3

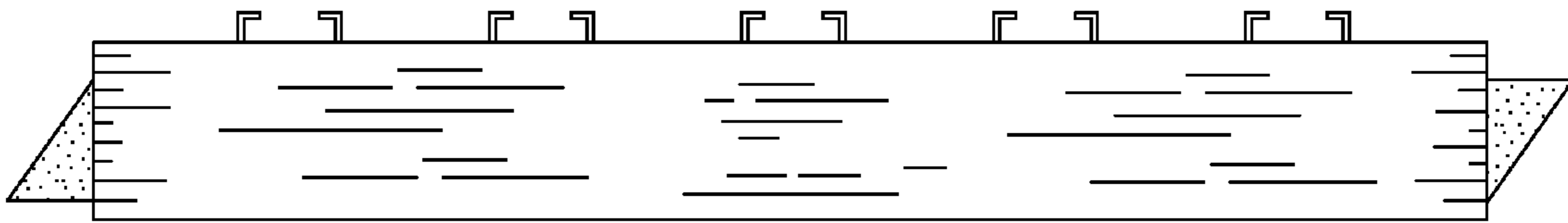

Fig. 4

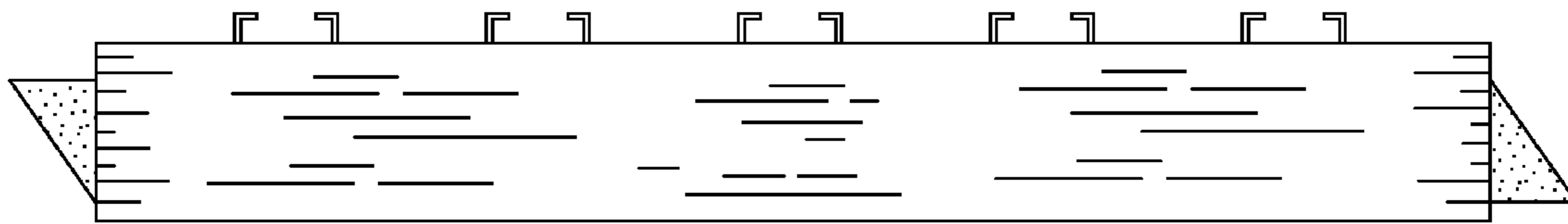

Fig. 5

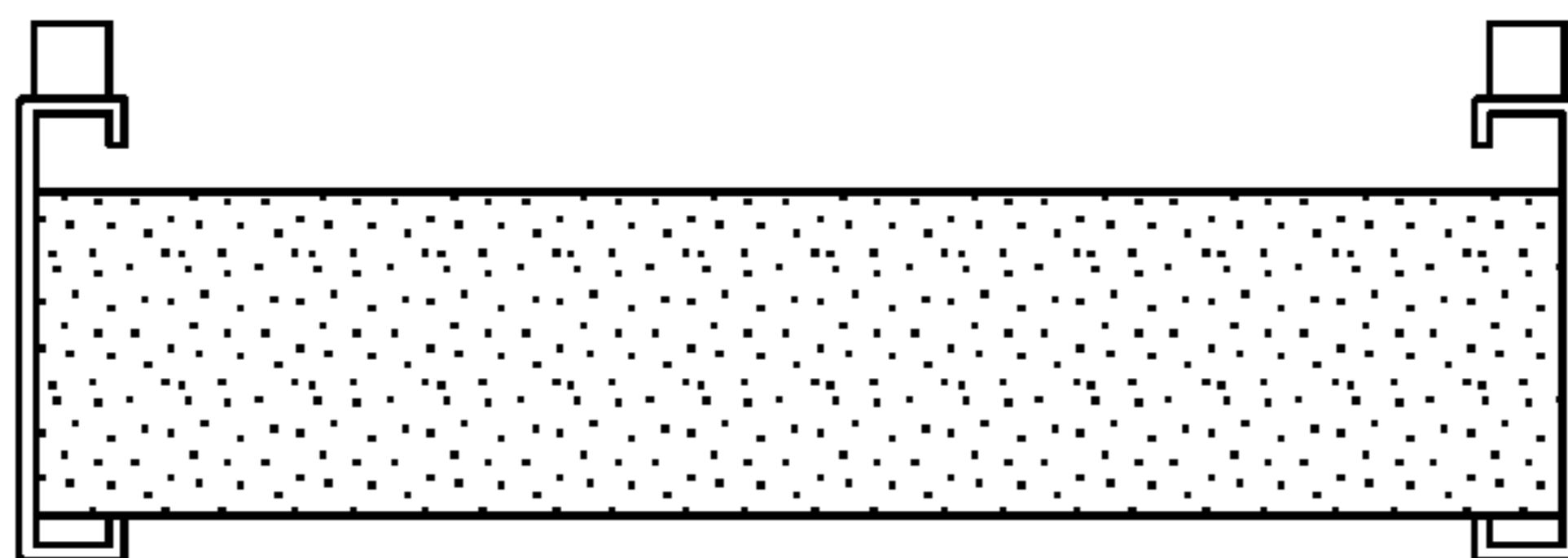

Fig. 6

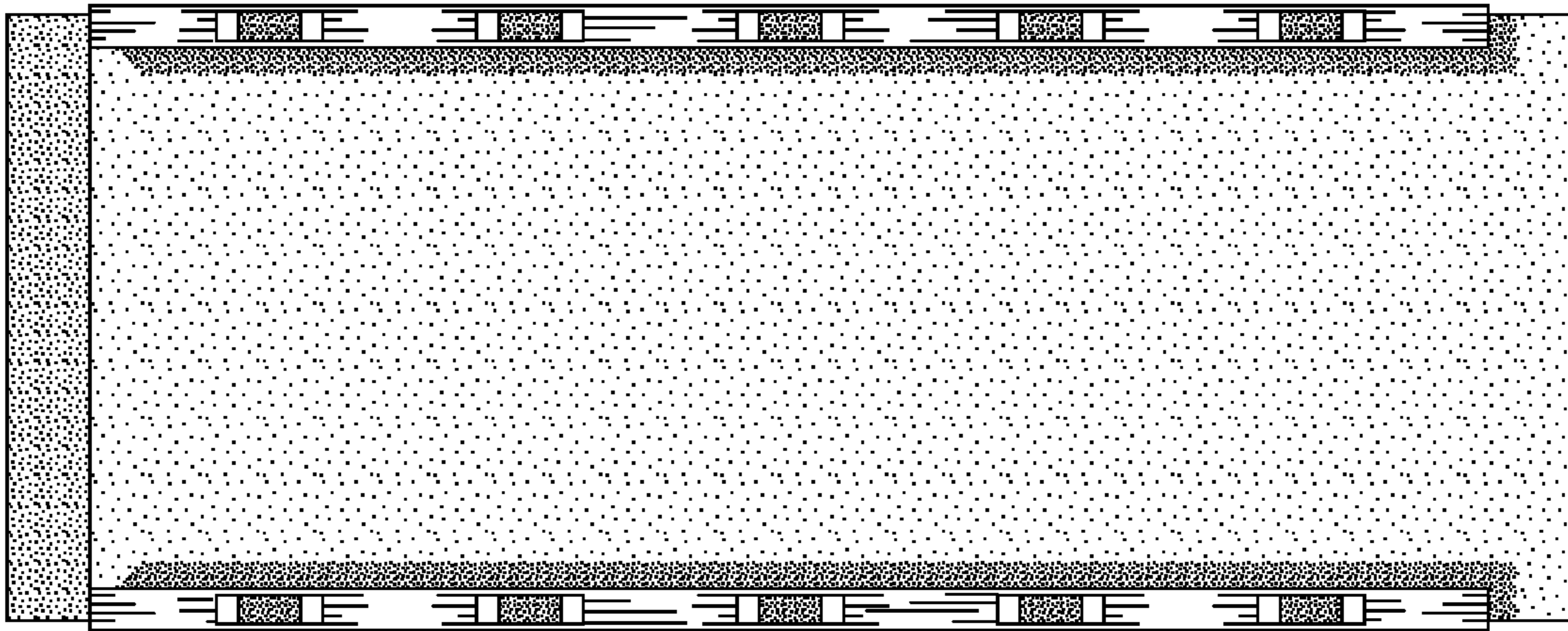

Fig. 7

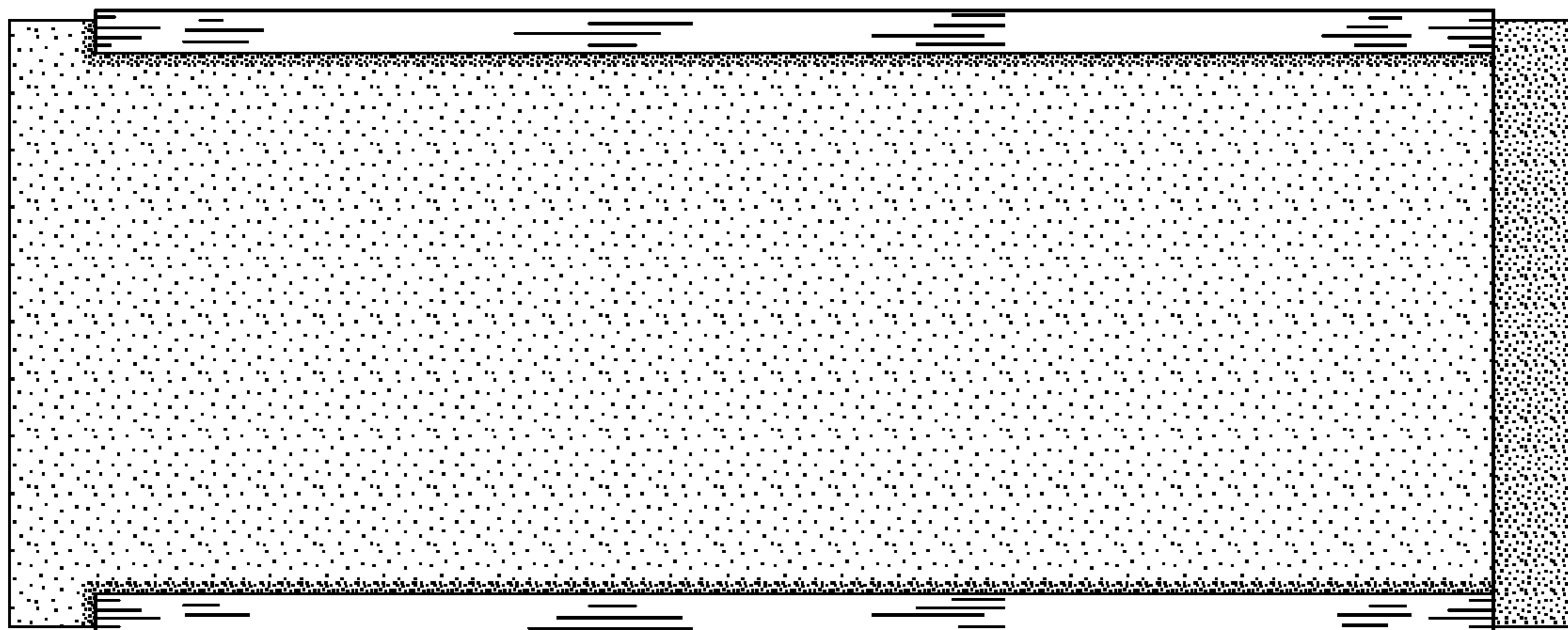

Fig. 8

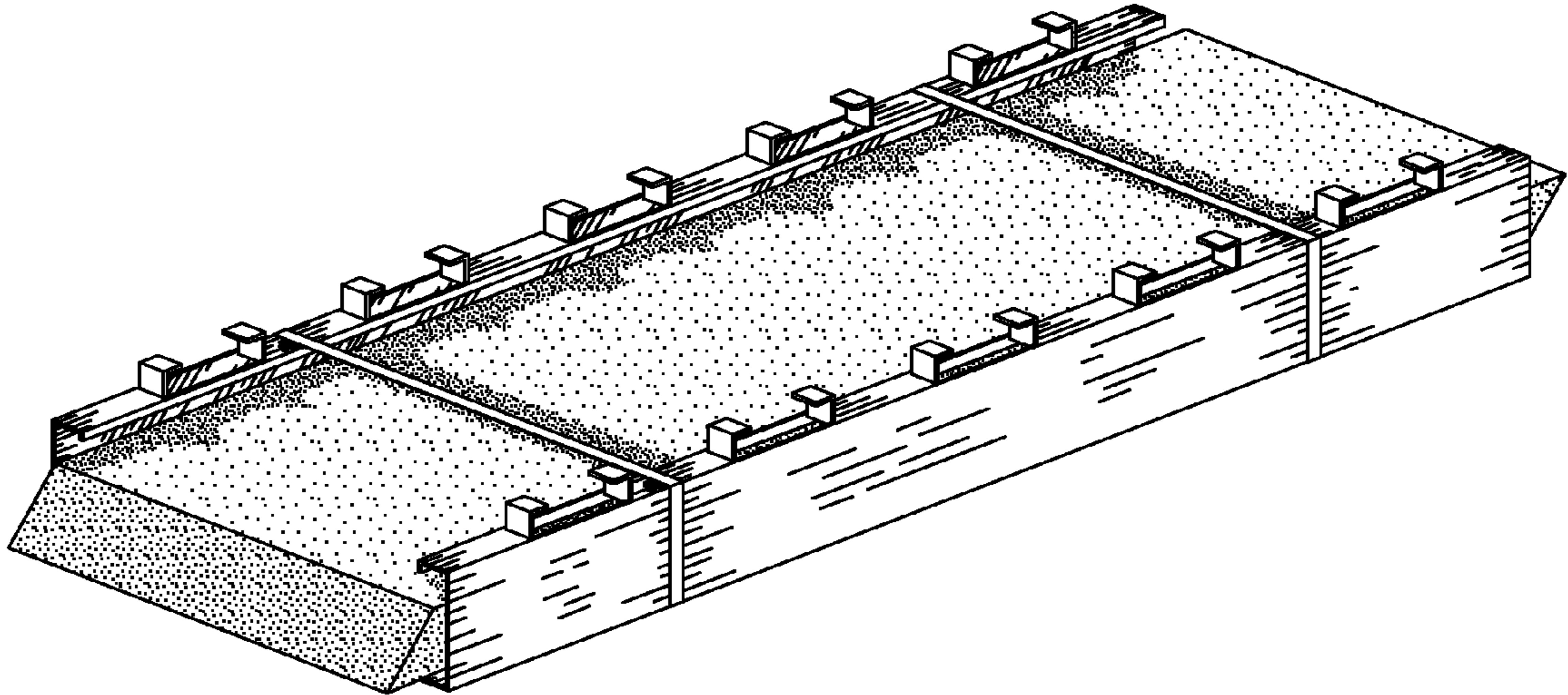

Fig. 9

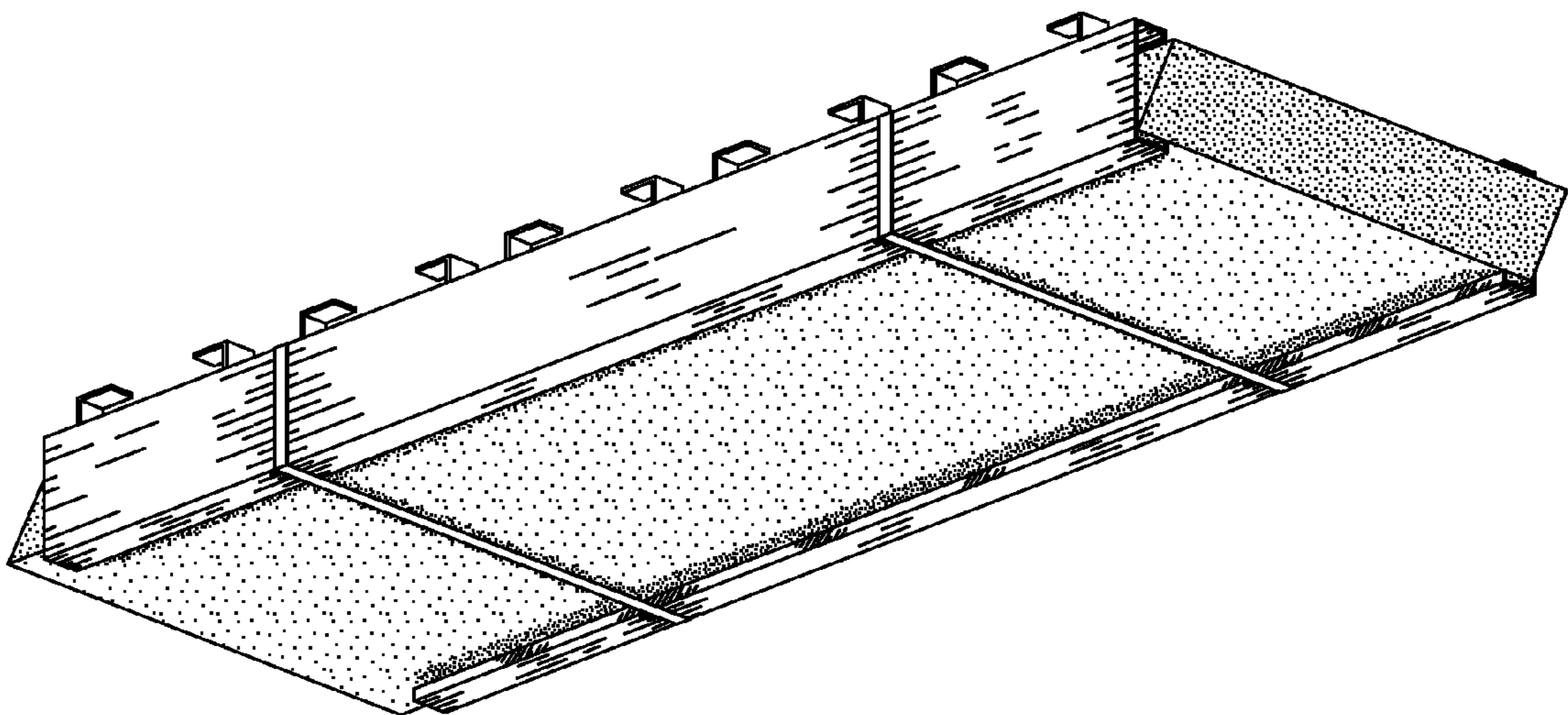

Fig. 10

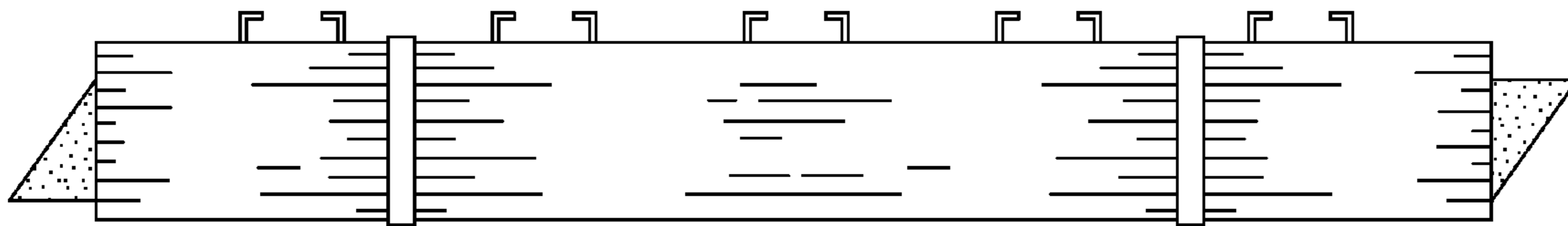

Fig. 11

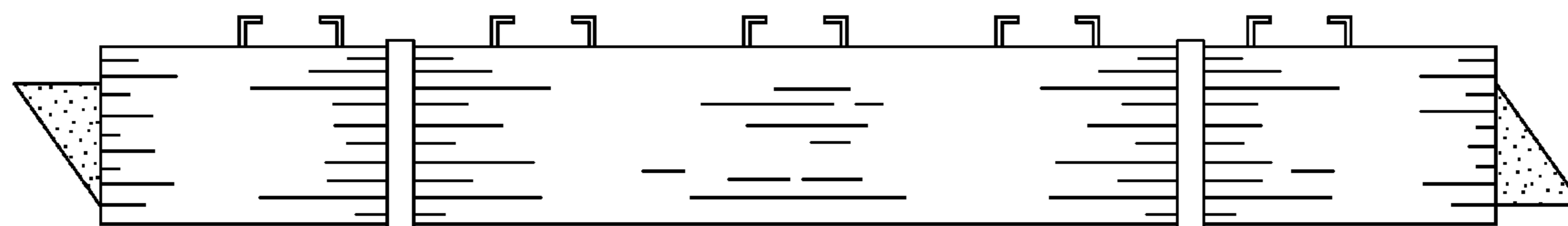

Fig. 12

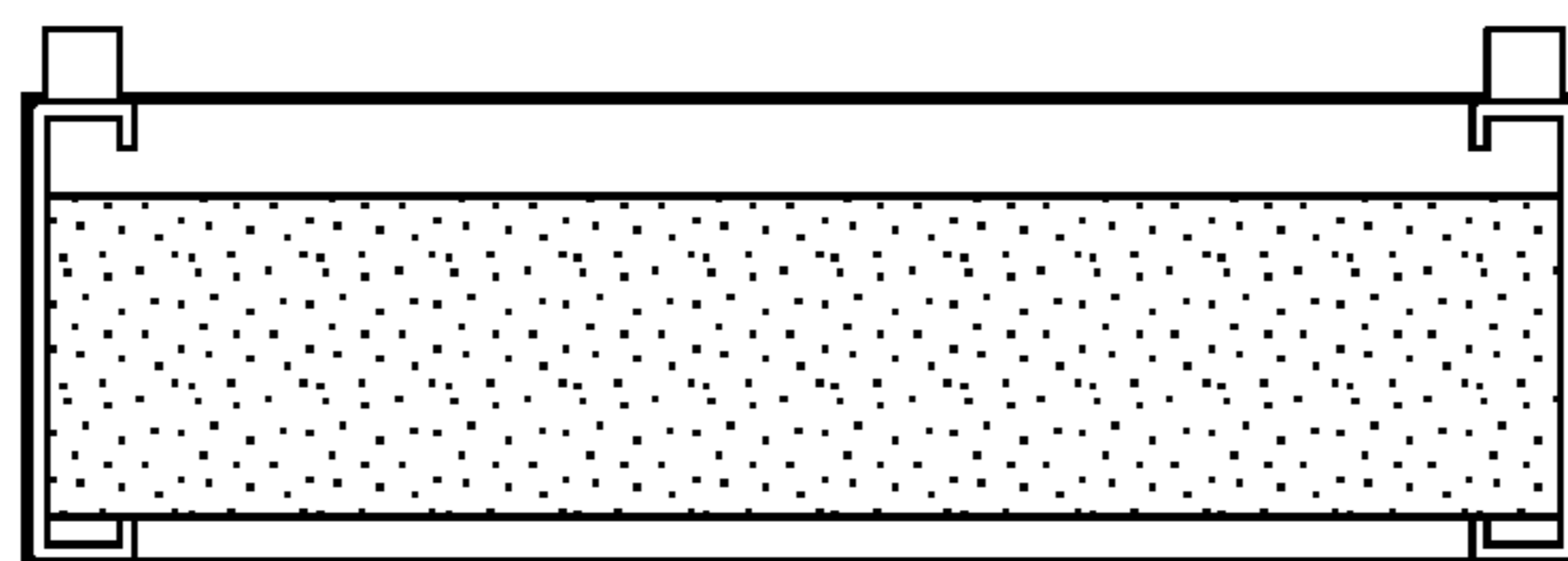

Fig. 13

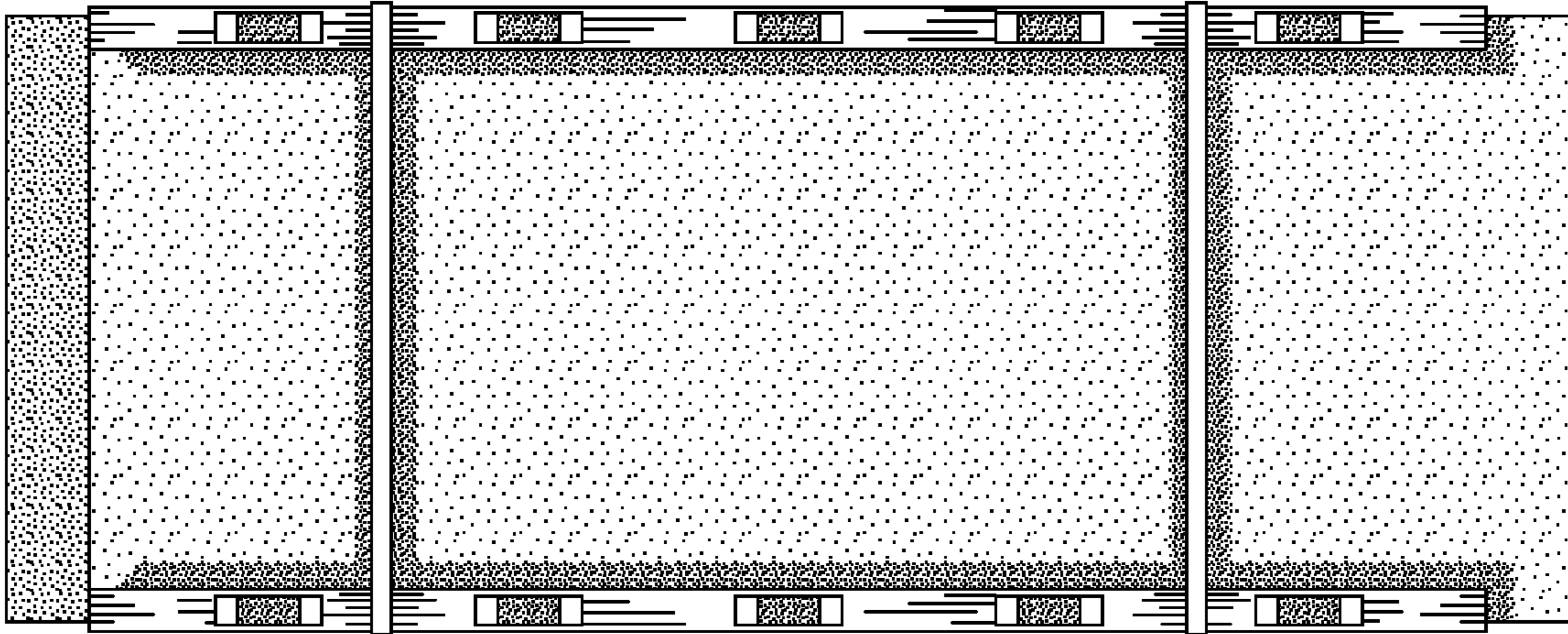

Fig. 14

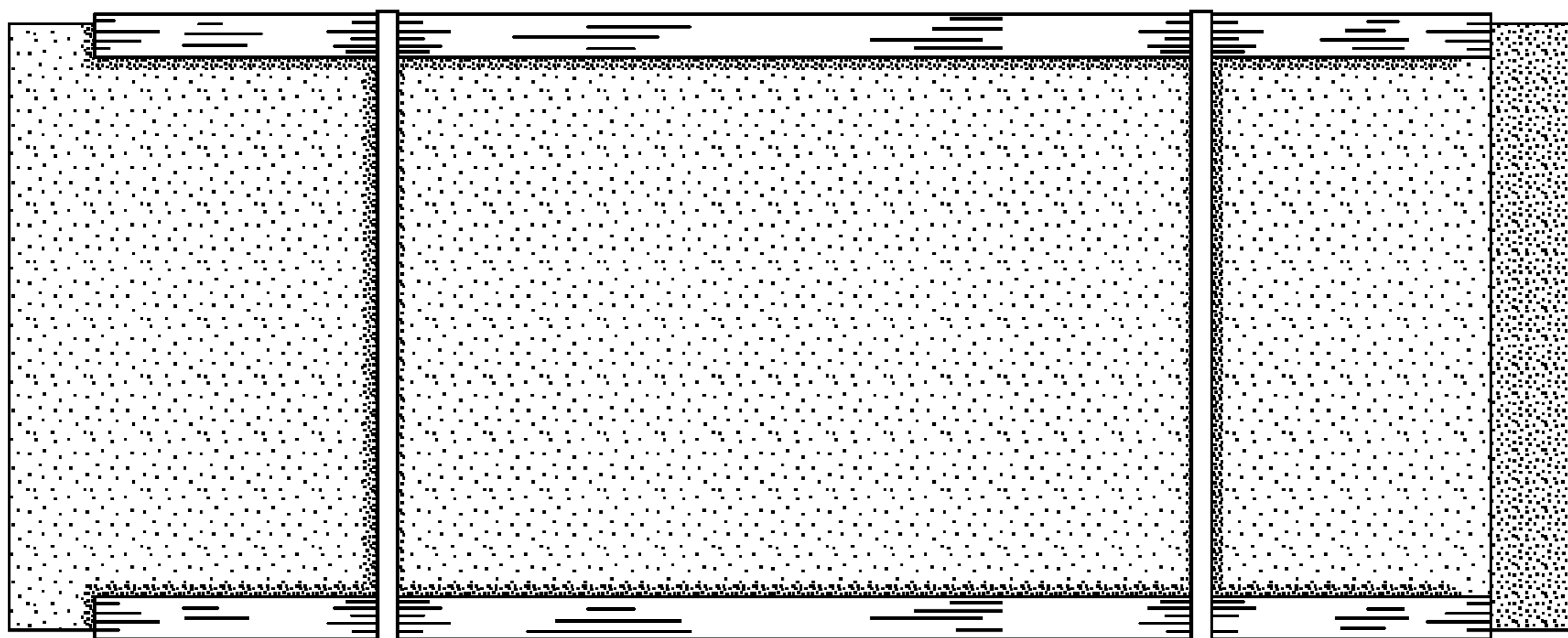

Fig. 15

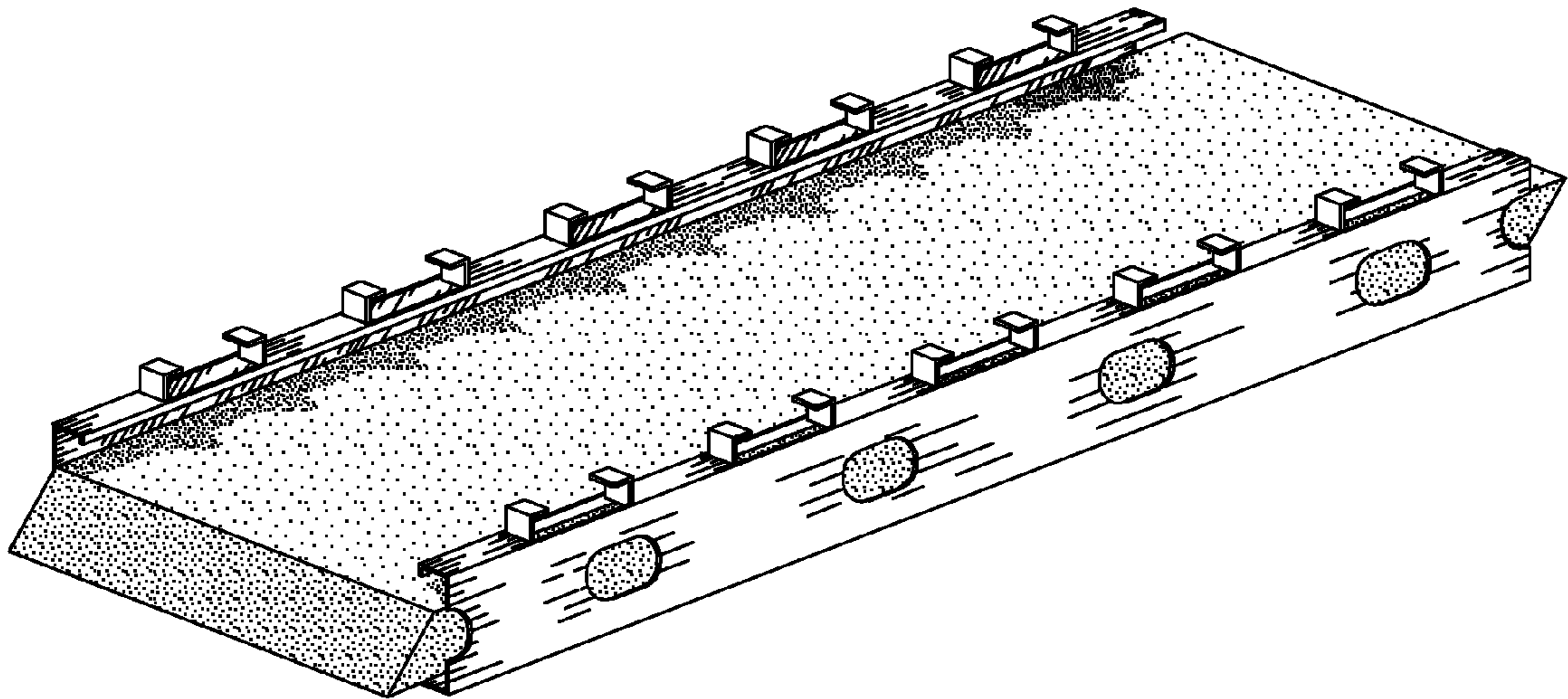

Fig. 16

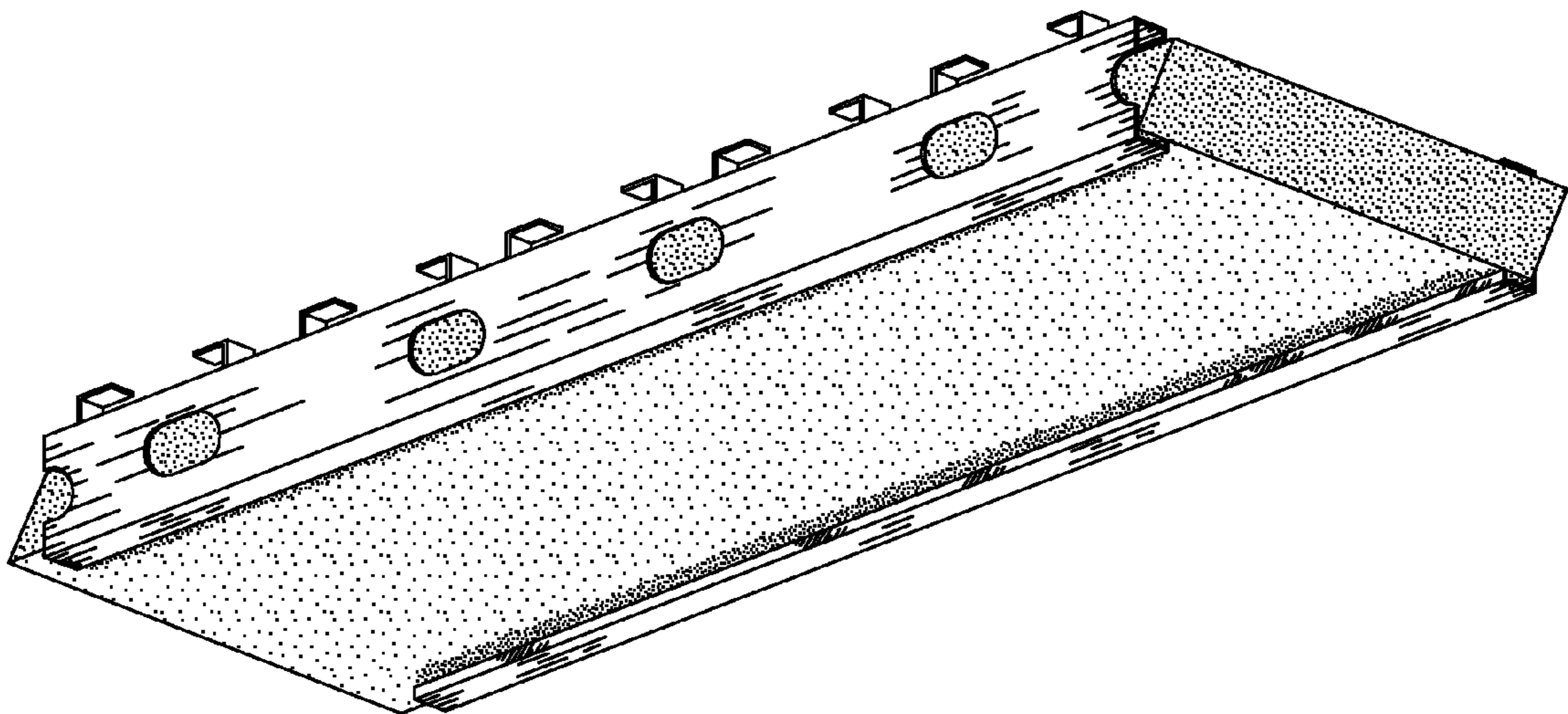

Fig. 17

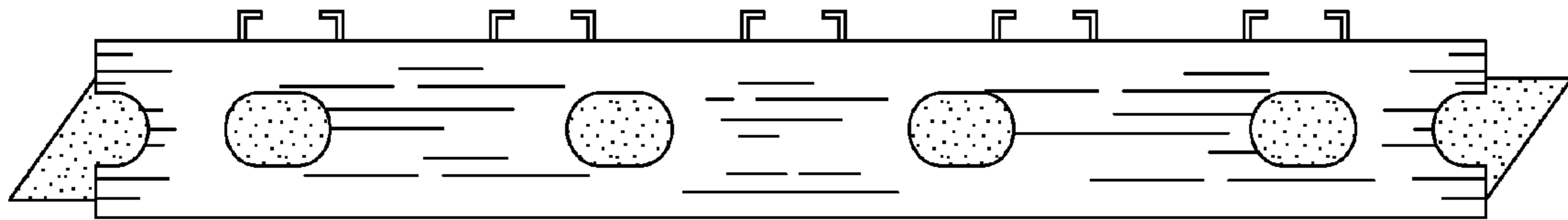

Fig. 18

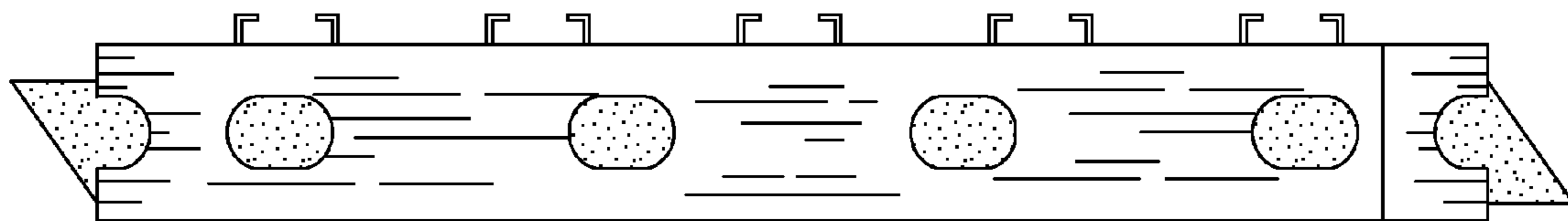

Fig. 19

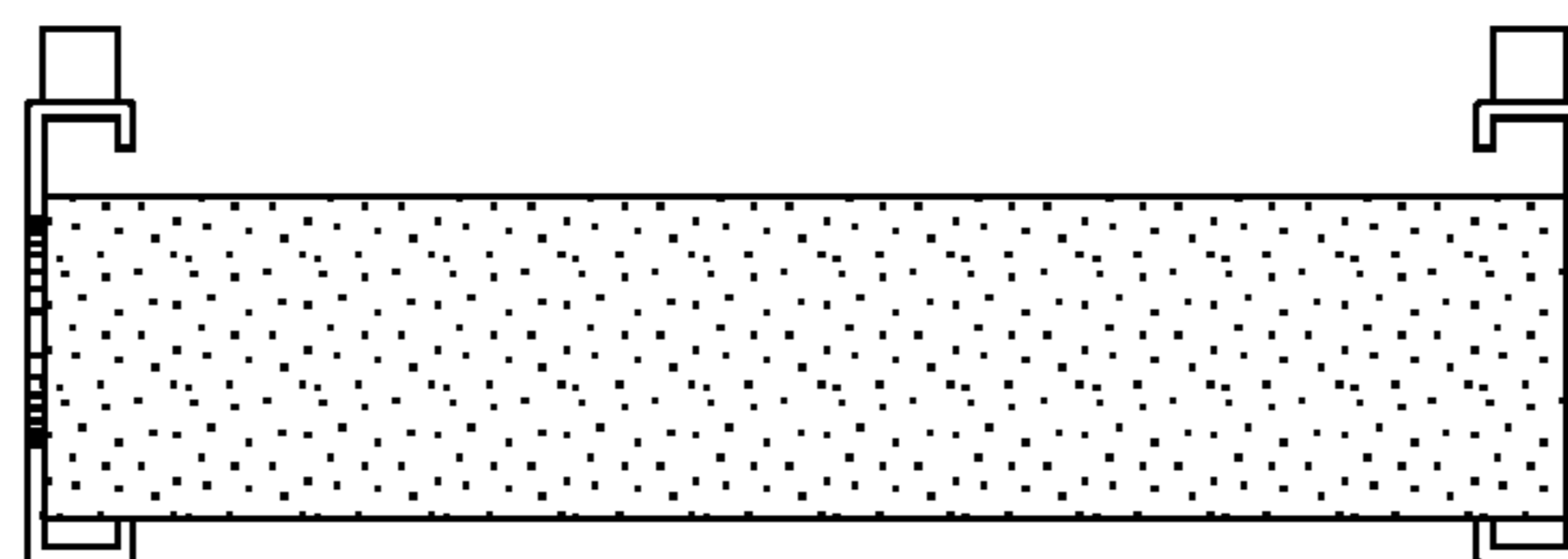

Fig. 20

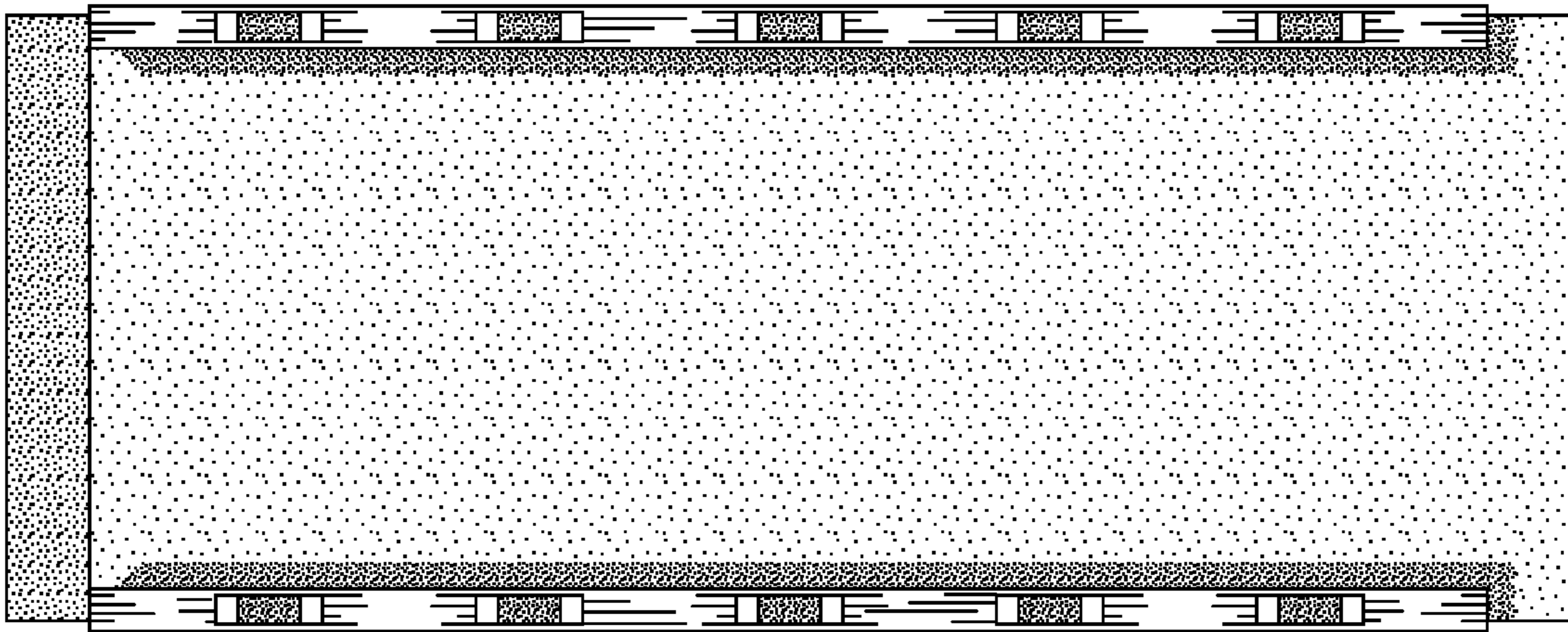

Fig. 21

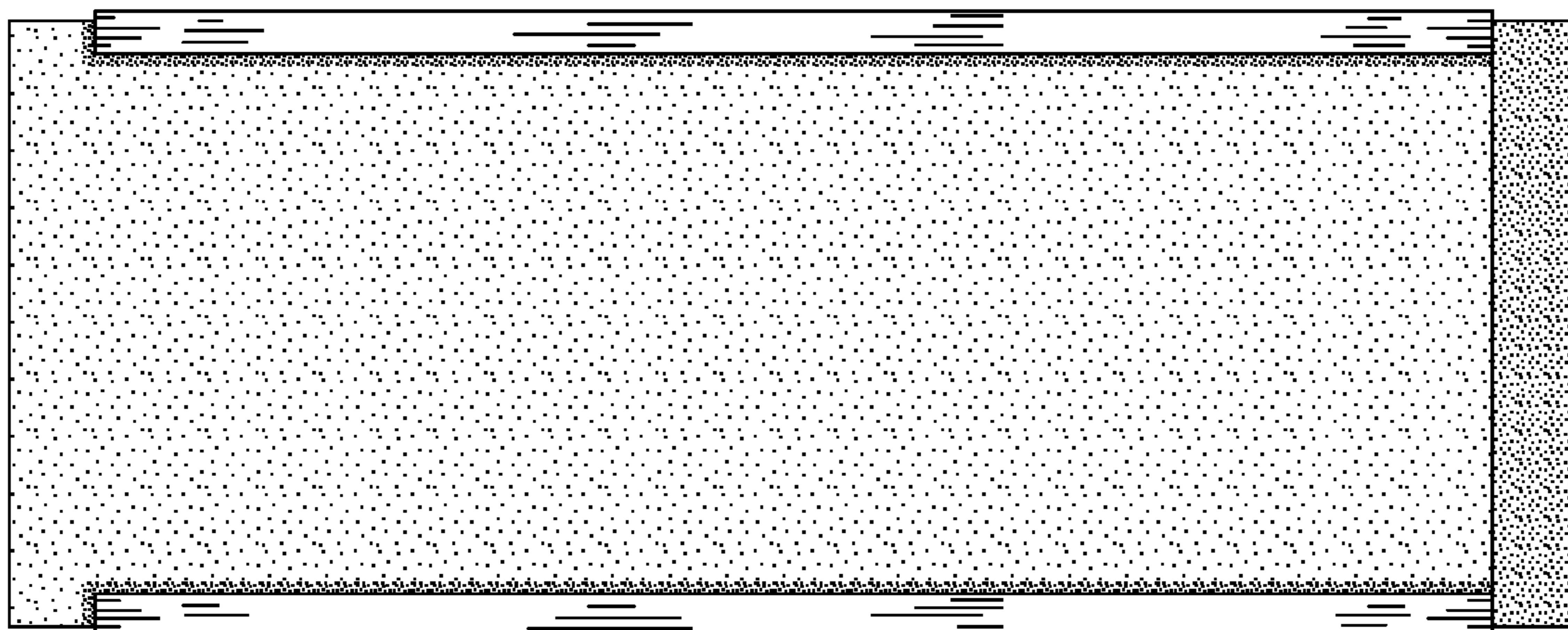

Fig. 22

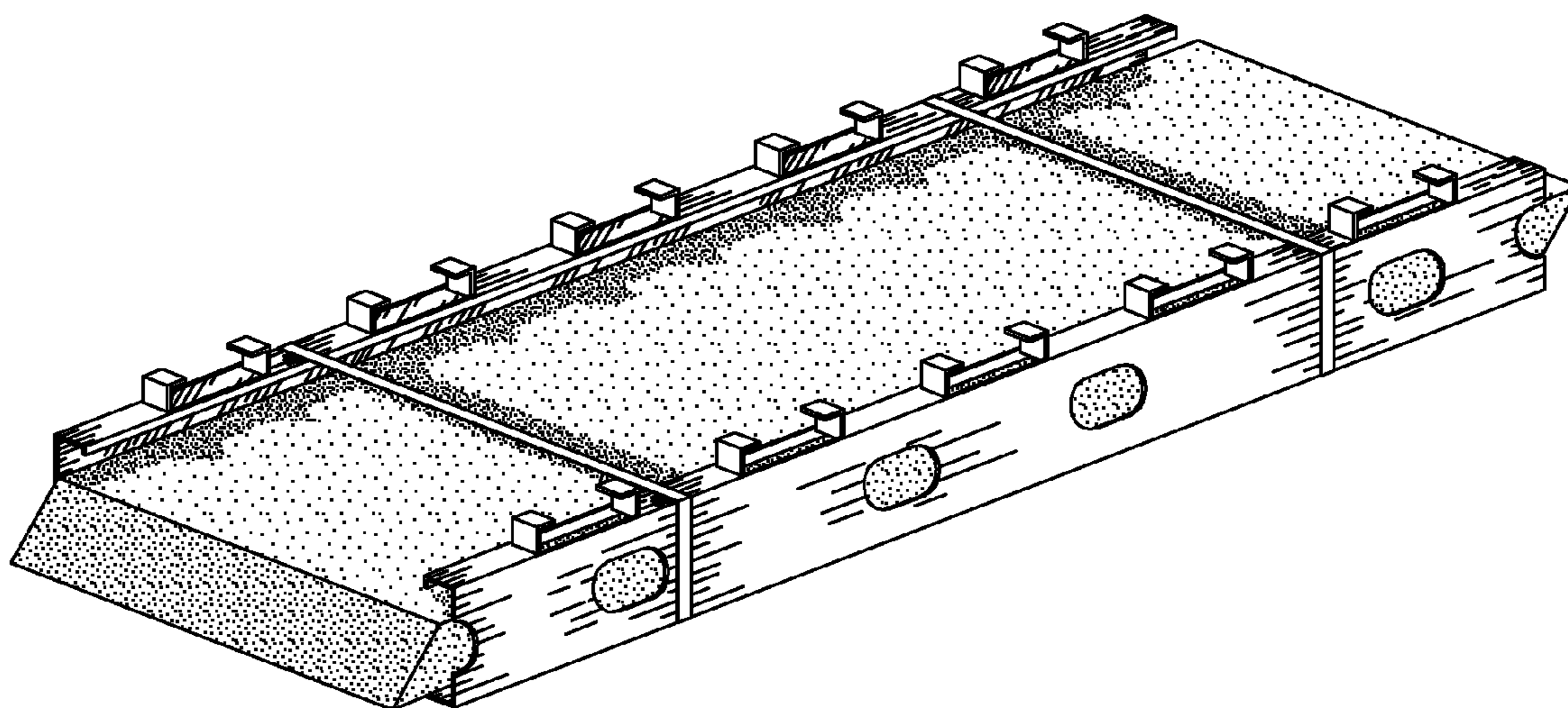

Fig. 23

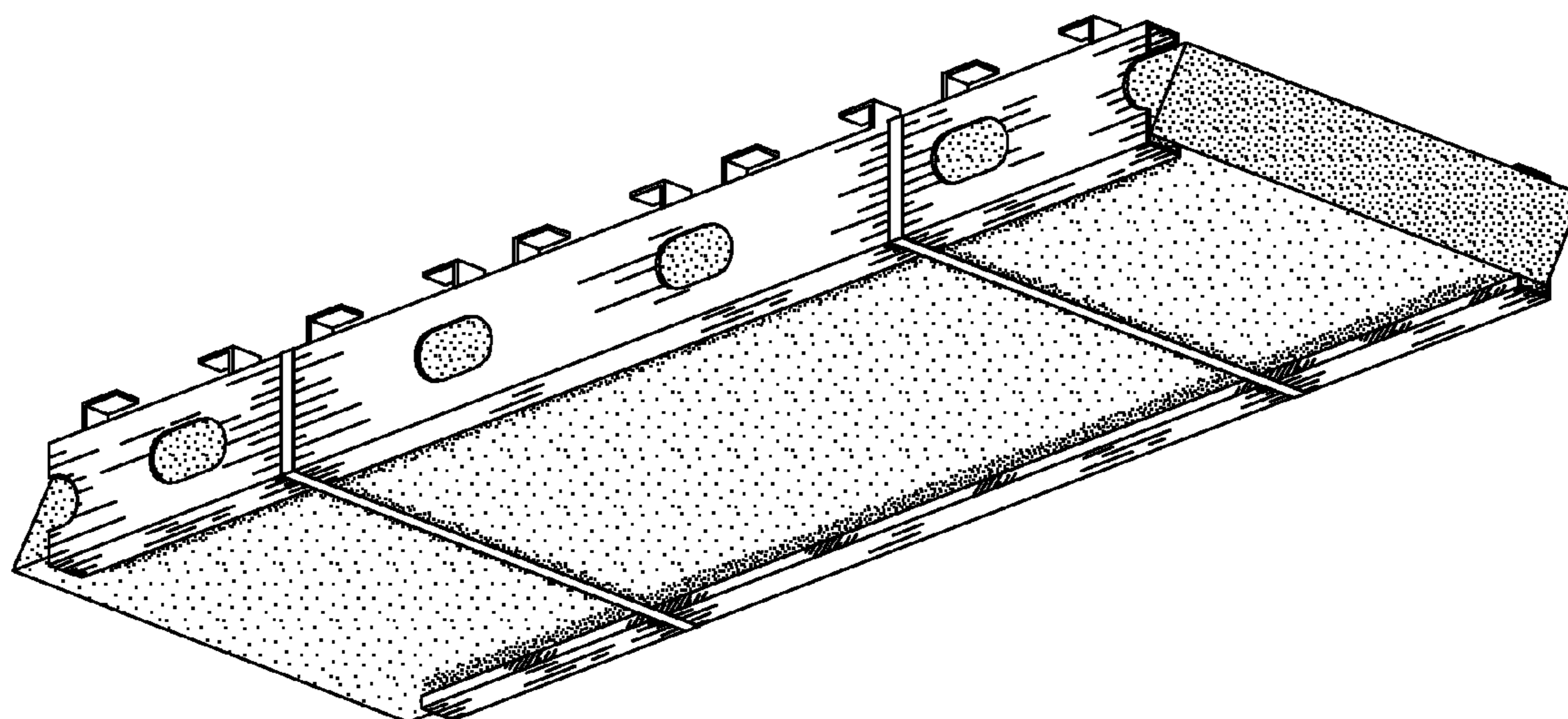

Fig. 24

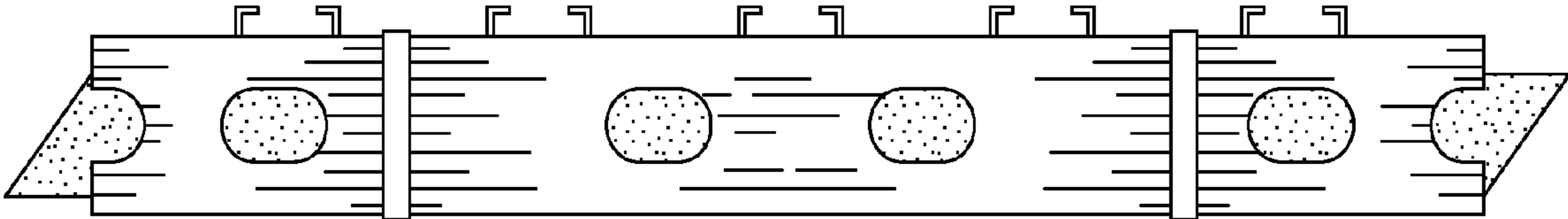

Fig. 25

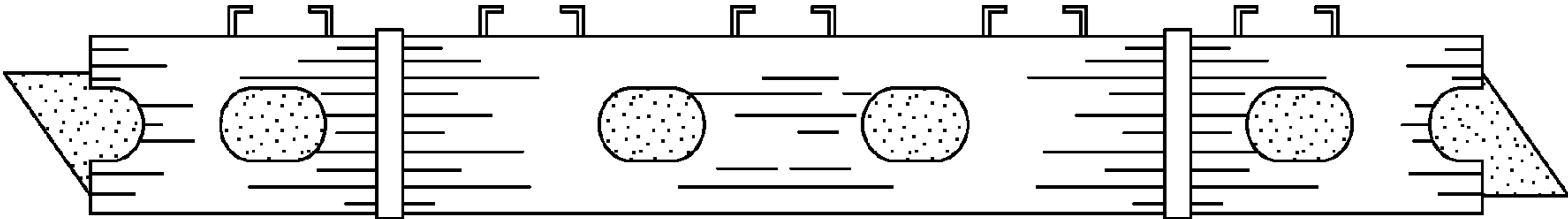

Fig. 26

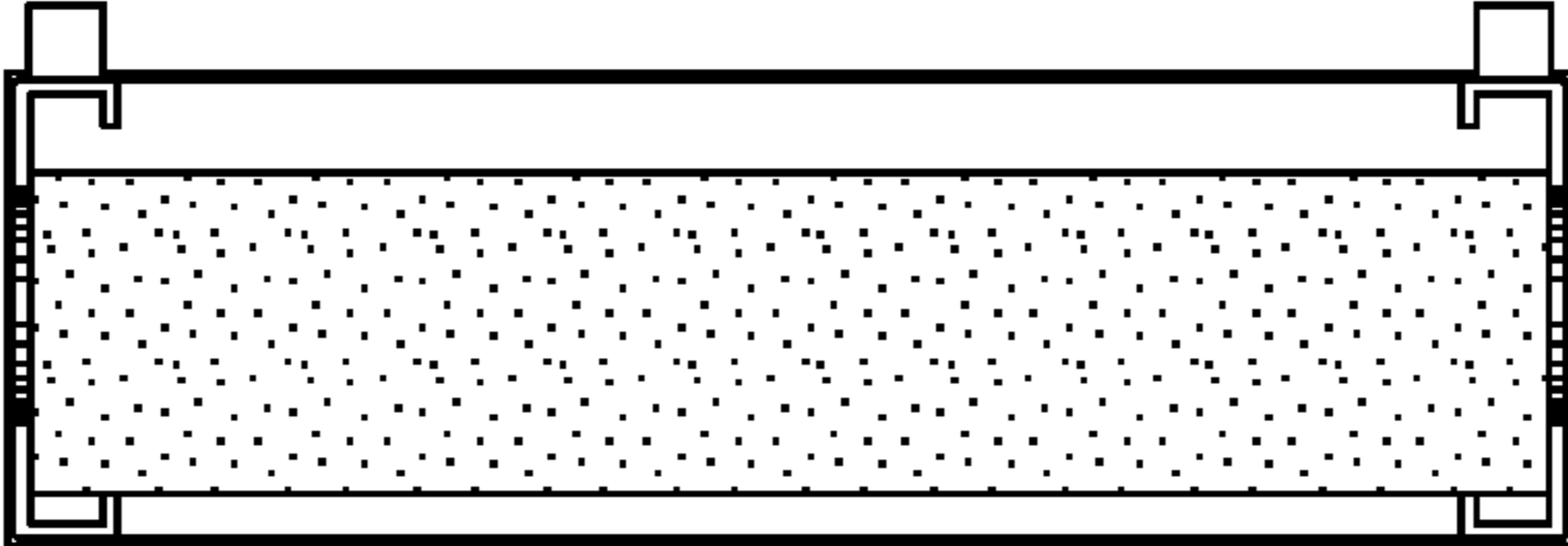

Fig. 27

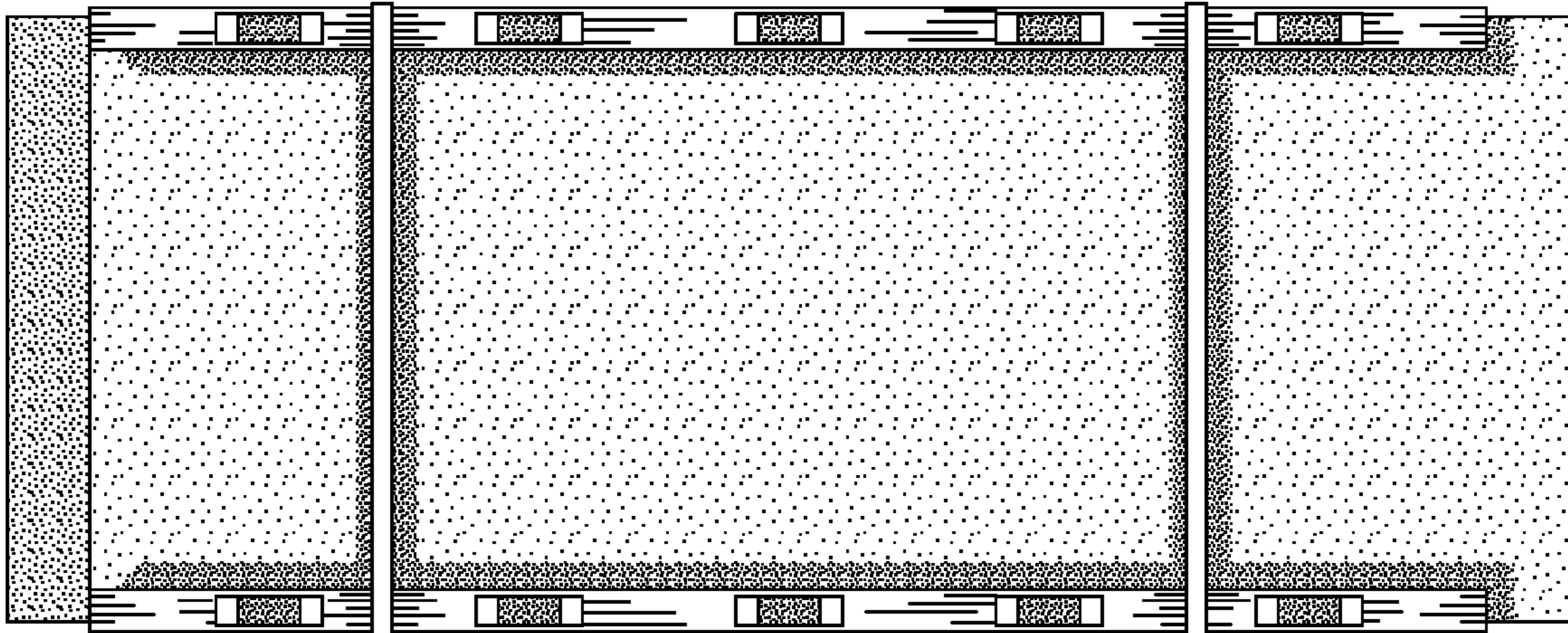

Fig. 28

